

NR(D)(EI), NR(D)4(EI)

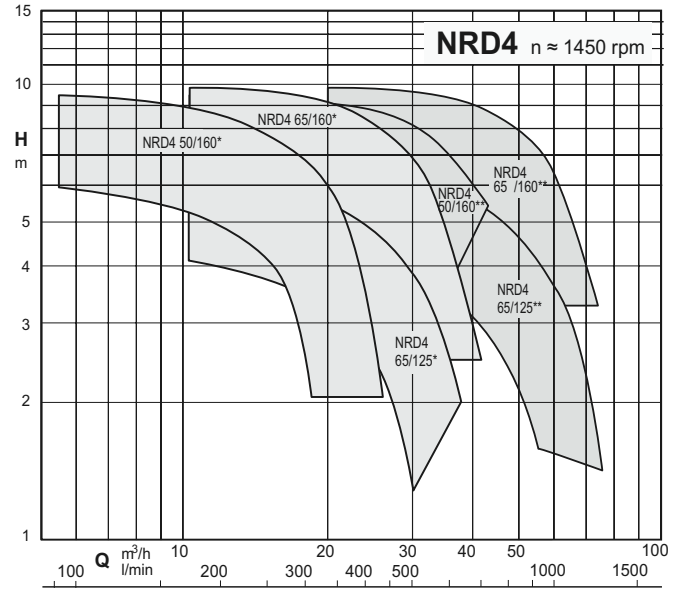

In-line pumps

Coverage chart

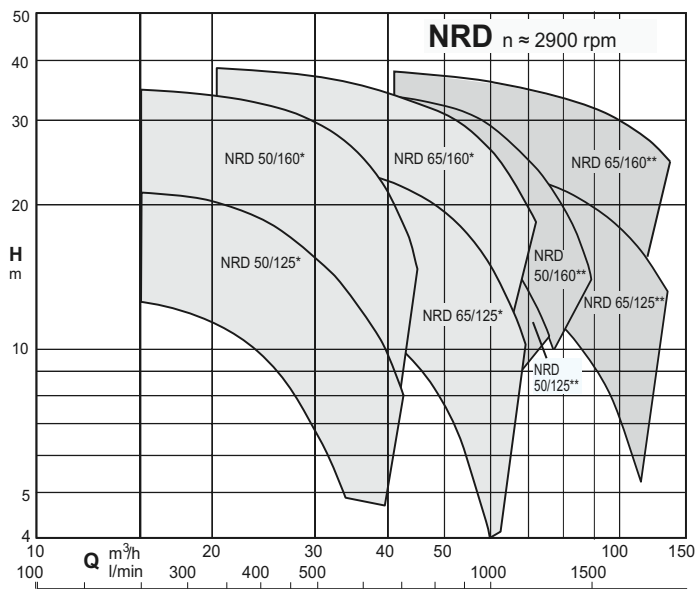
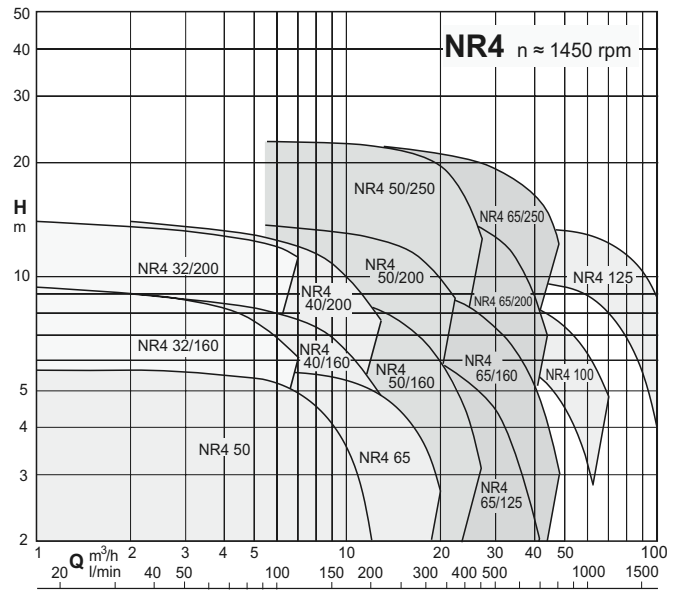
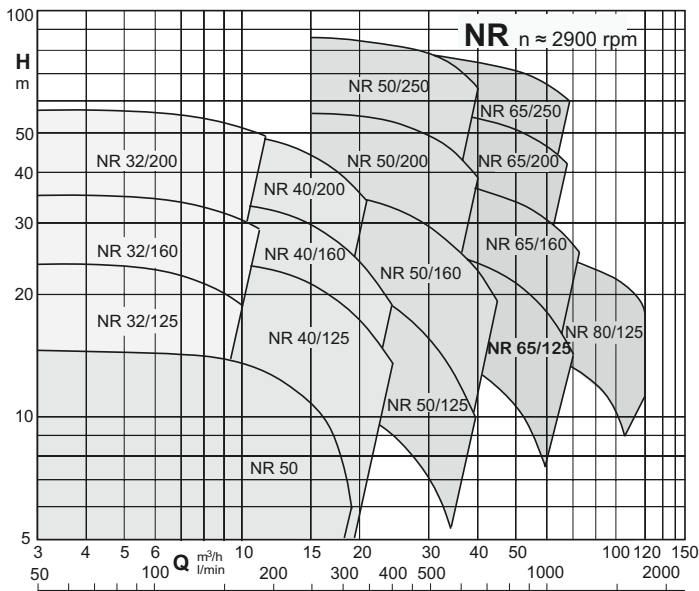

* Single operation
 ** Parallel operation

NR(D)(EI), NR(D)4(EI)



Construction

Close-coupled, single-impeller, centrifugal pumps; electric motor with extended shaft directly connected to the pump.

NR, NR4 series: Single head electropumps.

NRD, NRD4: Twin head pump with built-in automatic switching valve. The two head can operate singularly or in parallel.

Pump casing with suction and delivery connections with the same diameter and on the same axis (in-line).

Connections: Flanges according to PN 10, EN 1092-2.

Counter-flanges on request.

Sizes	Flanges
NR, NR4 32, 40, 50, 65 NRD, NRD4 50, 65	Screwed flanges EN 1092-1, PN 16
NR4 100 NR4 125	Flanges for welding EN 1092-1, PN 10 EN 1092-1, PN 10

Version with frequency converter (on request)

Applications

For clean liquids without abrasives, which are non-aggressive for the pump materials (solids content up to 0.2%).

For heating, air-conditioning, cooling and circulation plants.

For civil and industrial applications.

When low noise operation is required ($n \approx 1450$ rpm).

Operating conditions

Liquid temperature from -10 °C to $+90$ °C.

Ambient temperature up to 40 °C.

Total suction lift up to 7 m.

Maximum permissible working pressure up to 10 bar.

Continuous duty (S3 60% for 1,5 kW).

Motor

2-pole induction motor, 50 Hz ($n \approx 2900$ rpm).

NR(D): three-phase 230/400 V $\pm 10\%$ up to 3 kW;
400/690 V $\pm 10\%$ from 4 to 18,5 kW.

NRM: single-phase 230 V $\pm 10\%$.

4-pole induction motor, 50 Hz ($n \approx 1450$ rpm).

NR4: three-phase 230/400 V $\pm 10\%$ up to 3 kW;
400/690 V $\pm 10\%$ for 4 kW.

Insulation class F.

Protection IP 54.

Motor suitable for operation with frequency converter from 0,37 kW for NR4 and from 1,1 kW for NR(D).

IE2 efficiency class for single-phase motors up to 1,1 kW.

IE3 efficiency class for three-phase motors (IE2 up to 0,65 kW).

Constructed in accordance with EN 60034-1; EN 60034-30-1.

EN 60335-1, EN 60335-2-41.

Special features on request

Other voltages.

Frequency 60 Hz (as per 60 Hz data sheet).

Protection IP 55.

Special mechanical seal

Higher or lower liquid or ambient temperatures.

Motor suitable for operation with frequency converter up to 0,33 kW for NR(D)4 and up to 0,75 kW for NR(D).

Designation

Example: NR(D)4 EI 50/125A/A

NR = Series

4 = 4-pole version (without indication, 2-pole version)

D = Twin head

EI = With frequency converter I-MAT

50 = Delivery port diameter in mm

125 = Nominal impeller diameter

A = Impeller diameter

/A = It refers to a revision

The electropumps comply with the European Regulation no. 547/2012.

Materials

Components	Materials
Pump casing	Cast iron GJL 200 EN 1561
Lantern bracket	Cast iron GJL 200 EN 1561
Impeller	Cast iron GJL 200 EN 1561 (Brass CW617N EN 12165 for NR-NR4 32..., 40..., 50/200)
Shaft	Chrome-nickel steel 1.4305 EN 10088 (AISI 303) Steel 1.4104 EN 10088 (AISI 430F) from 3 kW to 18.5 kW
Valve	Chrome-nickel steel AISI 304 - NBR
Mechanical seal	Carbon - Ceramic - NBR
Counter-flanges	Steel 1.0044 EN 10025-2 (Fe 430B)

NR(D)(EI), NR(D)4(EI)



EI: Pumps with frequency converter

The NR(D) EI, NR4 EI, pumps are available with power from 0,25 kW up to 18,5 kW, the pumps are equipped with I-MAT installed on board. Which allows to realize a variable-speed system extremely compact and efficient, ideal in applications of water supply and in the distribution of hot and cold water. The pump is equipped with transducers suitable for operation and is already programmed at the factory.

Features

- Energy saving
- Compact design
- Easy to use
- Programmable to suit the system requirements
- Reliability

Construction

The system comprises of:

- Pump
- Induction motor (2 for NRD, NRD4)
- I-MAT Frequency converter (2 for NRD, NRD4)
- Motor adapter for the motor mounting of the frequency converter (2 for NRD, NRD4)
- Connection cable between frequency converter and induction motor
- Transducers
 - Communication cable for cascade mode for NRD, NRD4
 - 2 Cascade mode expansion board for NRD, NRD4

Main features

- Rated motor power output from 0,25 kW to 18,5 kW
- Control range from 1750 to 2900 rpm (2-pole)
- Control range from 870 to 1450 rpm (4-pole)
- Protection against dry running
- Protection against operations with closed valve ports
- Protection against system leakages
- Protection against overcurrent in the motor
- Protection against overvoltage and undervoltage of the power supply
- Protection against current unbalances between phases



Operating modes



Constant pressure mode

with pressure transducer

In this mode, the system maintains the preset pressure when the flow required by the installation changes.



Proportional pressure mode

with pressure transducer

In this mode the system changes the working pressure according to the required flow rate.



Constant flow mode

with flow meter

In this mode the system maintains a constant flow rate value in a point of the installation according to the required pressure.



Fixed speed mode

with setting of the speed preferential rotation.

In this mode, by changing the working frequency, you may choose any operational curve included within the working range.



Constant temperature mode

with temperature transducer

In this mode the system keeps the temperature constant inside a system by changing the speed of the pump.

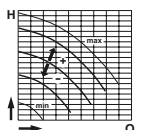
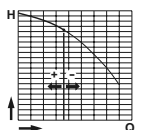
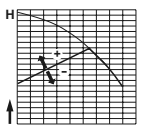
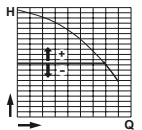

Coverage chart n ≈ 2900 rpm

Three-phase

Model	230V	400V	P2		Q = Flow														
					m³/h	l/min	0												
							6	6,6	7,5	8,4	9,6	10,8	12	13,2	15	16,8	18,9		
					H (m) = Total head														
NR 50D/A	2,3	1,3	0,45	0,6		11,6	11	10,8	10,5	10,2	9,5	8,5	7	6	-	-	-		
NR 50C/B	3,7	2,2	0,75	1		16,2	16	15,9	15,8	15,7	15,3	14,6	14	13	11	9	5,5		

Single-phase

Model	230V	P2			P1	Q = Flow														
						m³/h	l/min	0												
								6	6,6	7,5	8,4	9,6	10,8	12	13,2	15	16,8	18,9		
					H (m) = Total head															
NRM 50D/A	3,6	0,45	0,6	0,75		11,6	11	10,8	10,5	10,2	9,5	8,5	7	6	-	-	-			
NRM 50C/A	5,7	0,75	1	0		16,2	16	15,9	15,8	15,7	15,3	14,6	14	13	11	9	5,5			

Three-phase

Model	230V	400V	690V	P2		Q = Flow																	
						m³/h	l/min	0															
								2,4	3	3,6	4,8	6	6,6	7,5	8,4	9,6	10,8	12	13,2	15	16,8		
						H (m) = Total head																	
NR 32/125B	3	1,7	-	0,55	0,75		18,3	18,4	18,3	18,1	17,5	16,7	16,3	15,7	15	-	-	-	-	-	-		
NR 32/125A	3,7	2,2	-	0,75	1		23,3	23,3	23,2	23,1	22,6	21,9	21,5	20,8	20,1	19,1	-	-	-	-	-		
NR 32/160B/A	4,6	2,7	-	1,1	1,5		28,1	27,9	27,6	27,3	26,5	25,6	25,1	24,3	23,4	21,9	20	-	-	-	-		
NR 32/160A/A	7,5	4,3	-	1,5	2		36,8	36,3	36,1	35,7	35	34,3	33,8	33,2	32,4	31,2	29,7	-	-	-	-		
NR 32/200B/A	9,2	5,3	-	2,2	3		42,5	-	41,6	41,3	40,6	39,8	39,3	38,5	37,7	36,5	35,1	33,4	-	-	-		
NR 32/200A	11,5	6,6	-	3	4		51,2	-	49,7	49,5	48,9	48,2	47,9	47,2	46,5	45,4	44,2	42,8	41,2	37,9	-		
NR 32/200S/A	-	9,6	5,5	4	5,5		58	-	57,4	57,2	56,7	56,1	55,8	55,1	54,4	53,3	52	50,5	48,8	45,9	42,6		

Single-phase

Model	230V	P2			P1	Q = Flow											
						m³/h	l/min	0									
								2,4	3	3,6	4,8	6	6,6	7,5	8,4	9,6	10,8
						H (m) = Total head											
NRM 32/125B	4,2	0,55	0,75	0		18,3	18,4	18,3	18,1	17,5	16,7	16,3	15,7	15	-	-	-
NRM 32/125A	5,4	0,75	1	0		23,3	23,3	23,2	23,1	22,6	21,9	21,5	20,8	20,1	19,1	-	-
NRM 32/160B	7,4	1,1	1,5	1,6		38,2	27,9	27,6	27,3	26,5	25,6	25,1	24,3	23,4	21,9	20	-
NRM 32/160A	9,2	1,5	2	2		36,8	36,3	36,1	35,7	35	34,3	33,8	33,2	32,4	31,2	29,7	-

Three-phase

Model	230V	400V	690V	P2		Q = Flow															
						m³/h	l/min	0													
								6,6	7,5	8,4	9,6	10,8	12	13,2	15	16,8	18,9	21	24		
						H (m) = Total head															
NR 40/125C	4	2,3	-	0,75	1		15,5	15,7	15,5	15,3	14,8	14,3	13,6	12,9	11,6	10,2	8,1	5,8	-		
NR 40/125B/A	4,6	2,7	-	1,1	1,5		19,5	19,8	19,6	19,4	19	18,5	18	17,5	16,5	15,2	13,6	11,6	8,5		
NR 40/125A/A	7,5	4,3	-	1,5	2		23,3	23,7	23,7	23,6	23,4	23,1	22,8	22,4	21,7	20,6	19,1	17,3	14,2		
NR 40/160B/A	7,5	4,3	-	1,5	2		26,1	25,7	25,4	25,1	24,6	24	23,3	22,6	21,4	19,7	17,3	14,4	9,9		
NR 40/160A/A	9,2	5,3	-	2,2	3		33,6	32,9	32,6	32,3	31,8	31,3	30,6	29,9	28,7	27,2	25,2	23,1	19,4		
NR 40/200B	11,5	6,6	-	3	4		41,9	40,2	39,7	39,2	38,5	37,6	36,7	35,7	33,8	31	26,9	22	-		
NR 40/200A/A	-	9,6	5,5	4	5,5		52,4	49,6	49,1	48,5	47,6	46,7	45,7	44,7	43	41,2	38,6	34,8	-		

Single-phase

Model	230V	P2			P1	Q = Flow												
						m³/h	l/min	0										
								6,6	7,5	8,4	9,6	10,8	12	13,2	15	16,8	18,9	21
						H (m) = Total head												
NRM 40/125C	5,8	0,75	1	0,9		15,5	15,7	15,5	15,3	14,8	14,3	13,6	12,9	11,6	10,2	8,1	5,8	-
NRM 40/125B	7,4	1,1	1,5	1,6		19,5	19,8	19,6	19,4	19	18,5	18	17,5	16,5	15,2	13,6	11,6	8,5
NRM 40/125A	9,2	1,5	2	2		23,3	23,7	23,7	23,6	23,4	23,1	22,8	22,4	21,7	20,6	19,1	17,3	14,2
NRM 40/160B	9,2	1,5	2	2		26,1	25,7	25,4	25,1	24,6	24	23,3	22,6	21,4	19,7	17,3	14,4	9,9

Coverage chart n ≈ 2900 rpm

Three-phase

Model	230V	400V	690V	P2		Q = Flow															
						m³/h	l/min	H (m) = Total head													
								0	15	16,8	18,9	21	24	27	30	33	37,8	39	42	45	
NR 50/125F/A	4,6	2,7	-	1,1	1,5	14,9	13,8	13,4	12,8	12,1	11	9,9	8,4	6,9	-	-	-	-			
NR 50/125C/A	7,5	4,3	-	1,5	2	17,7	17,4	17	16,5	16	15	13,9	12,6	11,3	9	8,3	-	-			
NR 50/125A/B	9,2	5,3	-	2,2	3	22,2	21,7	21,4	21	20,6	19,8	18,8	17,5	16,3	14,1	13,5	12	-			
NR 50/160C/B	9,2	5,3	-	2,2	3	23,1	21,9	21,4	20,6	19,9	18,6	17,3	15,6	13,8	10,8	10	-	-			
NR 50/160B/A	11,5	6,6	-	3	4	28,6	27,9	27,4	26,7	26	24,6	23,1	21,3	19,7	16,6	15,7	13,6	-			
NR 50/160A/B	-	9,6	5,5	4	5,5	36,6	35,5	35,1	34,5	33,7	32,7	31,2	29,4	27,5	24,3	23,4	21,3	19,1			
NR 50/200D/B	-	9,6	5,5	4	5,5	41,8	37,8	36,8	35,7	34,5	32,4	30,1	27,6	24,9	-	-	-	-			
NR 50/200B/A	-	10,8	6,2	5,5	7,5	50,9	48,5	47,7	46,8	45,7	43,9	41,7	39,2	36,5	-	-	-	-			
NR 50/200A/A	-	14,3	8,3	7,5	10	56,7	54,9	54,3	53,4	52,4	50,7	48,9	46,5	44,1	39,7	38,8	-	-			
NR 50/250C/B	-	18,5	10,7	9,2	12,5	61,2	58,8	58	57,3	56,5	55	53,2	51,1	48,9	44,8	43,1	39,4	-			
NR 50/250B/A	-	21,5	12,4	11	15	69,4	67	66,4	65,5	64,8	63,2	61,5	59,6	57,7	53,8	52,6	50	-			
NR 50/250A/B	-	27,3	15,8	15	20	87	84,6	84,1	83,2	82,3	80,7	78,8	76,9	74,3	69,8	68,4	65,2	-			

Single-phase

Model	230V	P2			P1	Q = Flow									
						m³/h	l/min	H (m) = Total head							
								0	15	16,8	18,9	21	24	27	30
NRM 50/125F	7,4	1,1	1,5	-	14,9	13,8	13,4	12,8	12,1	11	9,9	8,4	6,9	-	-
NRM 50/125C	9,2	1,5	2	2	17,7	17,4	17	16,5	16	15	13,9	12,6	11,3	9	8,3

Three-phase

Model	230V	400V	690V	P2		Q = Flow															
						m³/h	l/min	H (m) = Total head													
								0	21	24	27	30	33	37,8	42	48	54	60	66	69	72
NR 65/125F/B	9,2	5,3	-	2,2	3	16,5	16	15,7	15,3	14,8	14,3	13,5	12,5	11,1	9,5	7,3	5,3	-	-		
NR 65/125D/A	11,5	6,6	-	3	4	21,1	20,2	19,9	19,6	19,2	18,7	17,9	16,9	15,2	13,3	11,3	9,1	-	-		
NR 65/125A/B	-	9,6	5,5	4	5,5	25	24,4	24,1	23,8	23,4	23	22,2	21,4	19,8	18	15,9	13,7	12,4	-		
NR 65/125S/B	-	9,6	5,5	4	5,5	27,2	26,3	26	25,7	25,4	25	24,3	23,6	22,1	20,3	18,3	16,1	14,7	-		
NR 65/160B/A	-	10,8	6,2	5,5	7,5	31,9	32	31,7	31,4	30,9	30,4	29,5	28,6	26,8	24,8	22,2	19,7	18,3	16,7		
NR 65/160A/A	-	14,3	8,3	7,5	10	39	39,3	39	38,7	38,3	37,9	36,9	36,1	34,7	32,9	30,6	28,1	26,7	25,3		
NR 65/200B/B	-	18,5	10,7	9,2	12,5	47,1	46,7	45,9	45,1	44,4	43,6	42	40,5	37,9	35,3	32,4	28,3	-	-		
NR 65/200A/A	-	21,5	12,4	11	15	54,2	53,3	52,8	52,3	51,5	50,7	49,2	47,5	45,1	41,9	38,1	34,5	-	-		
NR 65/200S/B	-	27,3	15,8	15	20	60,4	60,5	60,2	59,6	59	58	56,3	54,5	52,2	49,5	46,5	42,7	-	-		
NR 65/250C/A	-	21,5	12,4	11	15	54,6	54,8	54,2	53,5	52,8	52	50,5	48,9	46,3	43,5	40,6	37,3	-	-		
NR 65/250B/B	-	27,3	15,8	15	20	67,1	67,2	66,7	66	65,1	64,3	62,8	61,3	58,6	55,8	52,9	49,7	-	-		
NR 65/250A/C	-	34	19,6	18,5	25	78,5	78,5	77,8	77,3	76,7	76	74,8	73,6	71,1	68,4	65,5	62,2	-	-		

Three-phase

Model	400V	690V	P2		Q = Flow											
					m³/h	l/min	H (m) = Total head									
							0	37,8	42	48	54	60	66	75	84	96
NR 80/125E	9,6	5,5	4	5,5	18,9	16,8	16,5	16,1	15,7	15,3	14,8	14	13,1	11,5	9,2	-
NR 80/125C	10,8	6,2	5,5	7,5	21,6	20,5	20,3	20	19,7	19,3	18,9	18,3	17,4	15,9	13,9	11
NR 80/125A	14,3	8,3	7,5	10	27	25,8	25,7	25,5	25,3	25	24,8	24,2	23,4	22,1	20,2	17,7

P1: Maximum power input.

P2: Rated motor power output.

Tolerances according to UNI EN ISO 9906:2012

NR(D)(EI), NR(D)4(EI)



Performance n ≈ 1450 rpm

Three-phase

					Q = Flow											
					m³/h	0	2	4	6	8	10	12	14	16	18	20
Model	230V	400V	P2		l/min											
	A		kW	HP												
NR4 50C/A	1,3	0,75	0,25	0,34		3,9	3,9	3,8	3,3	2,5	-	-	-	-	-	-
NR4 50B/A	1,3	0,75	0,25	0,34		4,7	4,7	4,6	4,3	3,5	2,3	-	-	-	-	-
NR4 50A/A	1,3	0,75	0,25	0,34		5,6	5,6	5,5	5,2	4,5	3,5	2	-	-	-	-
NR4 65C/A	1,3	0,75	0,25	0,34		3,8	-	-	3,8	3,7	3,5	3,1	2,6	1,9	-	-
NR4 65B/A	2,1	1,2	0,33	0,45		4,7	-	-	4,7	4,6	4,5	4,2	3,8	3,2	2,5	-
NR4 65A/A	2,1	1,2	0,33	0,45		5,6	-	-	5,6	5,5	5,3	5	4,6	4,1	3,5	2,7

Single-phase

					Q = Flow									
					m³/h	0	2	4	6	8	10	12	14	16
Model	230V	P2		P1	l/min									
	A	kW	HP	kW										
NR4M 50C/A	2,1	0,25	0,34	0,27		3,9	3,9	3,8	3,3	2,5	-	-	-	-
NR4M 50B/A	2,1	0,25	0,34	0,29		4,7	4,7	4,6	4,3	3,5	2,3	-	-	-
NR4M 50A/A	2,1	0,25	0,34	0,33		5,6	5,6	5,5	5,2	4,5	3,5	2	-	-
NR4M 65C/A	2,1	0,25	0,34	0,31		3,8	-	-	3,8	3,7	3,5	3,1	2,6	1,9

Three-phase

					Q = Flow																	
					0	1	1,2	1,5	1,89	2,4	3	3,6	4,2	4,8	5,4	6	6,6	7,5	8,4	9,6		
Model	230V	400V	P2		l/min																	
	A		kW	HP																		
NR4 32/160B/A	1,65	0,95	0,37	0,5	8,1	7,9	7,9	7,7	7,6	7,4	7,2	6,9	6,6	6,1	5,6	4,4	-	-	-			
NR4 32/160A/A	1,65	0,95	0,37	0,5	9,2	9,3	9,3	9,2	9,1	9	8,8	8,6	8,3	8	7,6	7,2	6,6	5,6	-			
NR4 32/200C/A	1,65	0,95	0,37	0,5	11,5	11,3	11,3	11,2	11,1	10,9	10,7	10,5	10,2	9,9	9,5	9,1	8,5	7,4	5,7			
NR4 32/200B/A	2,6	1,5	0,55	0,75	13,2	13,2	13,2	13,1	13	12,9	12,8	12,6	12,4	12,1	11,8	11,4	10,9	10	9,1	7,5		
NR4 32/200A/A	3,3	1,9	0,75	1	14,6	14,5	14,5	14,4	14,3	14,2	14,1	13,9	13,8	13,5	13,2	12,8	12,3	11,4	10,5	9,1		

Three-phase

					Q = Flow																	
					m³/h	0	2,4	3	3,6	4,8	5,4	6	7,5	8,4	9,6	10,8	12	13,2	15			
Model	230V	400V	P2		l/min																	
	A		kW	HP																		
NR4 40/160B/A	1,65	0,95	0,37	0,5		7,3	7,3	7,2	7,1	6,9	6,8	6,6	6,1	5,8	5,2	4,4	3,5	2,5	-			
NR4 40/160A/A	1,65	0,95	0,37	0,5		9,1	9	9	9	8,8	8,7	8,6	8,1	7,8	7,2	6,5	5,7	4,8	3,3			
NR4 40/200B/A	2,6	1,5	0,55	0,75		12,9	12,5	12,4	12,2	11,9	11,7	11,4	10,7	10,2	9,1	7,7	6,2	4,4	-			
NR4 40/200A/A	3,3	1,9	0,75	1		14,7	14,3	14,2	14,1	13,9	13,7	13,5	12,9	12,4	11,6	10,5	9,2	7,7	4,9			

Three-phase

					Q = Flow																			
					m³/h	0	5,4	6	7,5	8,4	9,6	10,8	12	13,2	15	16,8	18,9	21	24	27	30			
Model	230V	400V	P2		l/min																			
	A		kW	HP																				
NR4 50/160C/A	1,65	0,95	0,37	0,5		5,9	5,9	5,8	5,7	5,6	5,4	5,2	5	4,7	4,2	3,7	3,1	2,3	-	-				
NR4 50/160B/A	2,6	1,5	0,55	0,75		7,3	7,4	7,4	7,2	7,1	6,9	6,7	6,4	6,2	5,7	5,2	4,5	3,8	2,5	-				
NR4 50/160A/B	3,3	1,9	0,75	1		9,2	9,2	9,2	9,1	9	8,9	8,7	8,4	8,2	7,6	7,1	6,4	5,6	4,4	3,1				
NR4 50/200B/B	5	2,9	1,1	1,5		12,8	12,6	12,5	12,3	12,1	11,9	11,5	11,2	10,7	10	9,2	8,2	7,1	5,2	-				
NR4 50/200A/B	5	2,9	1,1	1,5		14,3	14,1	14	13,9	13,7	13,5	13,2	12,8	12,4	11,7	11	10	8,8	7,3	-				
NR4 50/250C/B	6	3,5	1,5	2		17,1	17	16,9	16,6	16,4	16,1	15,9	15,6	15,2	14,6	13,9	12,8	11,3	8,5	5,3				
NR4 50/250B/B	8,6	5	2,2	3		21	20,9	20,8	20,5	20,3	20	19,7	19,4	19	18,4	17,8	16,8	15,6	13,8	11,7				
NR4 50/250A/A	11,1	6,4	3	4		22	21,9	21,9	21,8	21,6	21,4	21,1	20,9	20,5	19,9	19,2	18,3	17,2	15,3	13,4				

P1: Maximum power input.

P2: Rated motor power output.

Tolerances according to UNI EN ISO 9906:2012

NR(D)(EI), NR(D)4(EI)



Performance n ≈ 1450 rpm

Three-phase

						Q = Flow															
						m³/h	0	10,8	12	13,2	15	16,8	18,9	21	24	27	30	33	42	48	
Model	230V	400V	690V	P2		l/min	180	200	220	250	280	315	350	400	450	500	550	700	800		
	A			kW	HP	H (m) = Total head															
NR4 65/125F/A	1,65	0,95	-	0,37	0,5	4,1	3,9	3,8	3,8	3,6	3,5	3,3	3	2,6	2,1	1,6	1	-	-		
NR4 65/125D/A	2,6	1,5	-	0,55	0,75	5,3	5	5	4,9	4,8	4,7	4,5	4,3	3,9	3,4	2,9	2,4	-	-		
NR4 65/125A/B	3,3	1,9	-	0,75	1	6,3	6,2	6,1	6	5,9	5,8	5,7	5,5	5,1	4,6	4,1	3,5	1,5	-		
NR4 65/125S/B	3,3	1,9	-	0,75	1	6,8	6,6	6,6	6,5	6,4	6,3	6,1	5,9	5,6	5,1	4,6	4,1	2,1	-		
NR4 65/160B/B	5	2,9	-	1,1	1,5	8,2	8,2	8,2	8,1	8	7,9	7,7	7,5	7,1	6,6	6	5,4	3,2	-		
NR4 65/160A/B	5	2,9	-	1,1	1,5	9,7	9,6	9,5	9,5	9,4	9,2	9	8,8	8,5	8	7,4	6,8	4,7	3		
NR4 65/200C/B	5	2,9	-	1,1	1,5	11,4	11,3	11,2	11,1	10,8	10,6	10,3	9,9	9,4	8,7	7,9	7	3,4	-		
NR4 65/200B/B	6	3,5	-	1,5	2	13,3	13,1	13	12,9	12,7	12,4	12,1	11,8	11,2	10,5	9,7	8,9	5,4	-		
NR4 65/200A/B	8,6	5	-	2,2	3	14,5	14,6	14,5	14,4	14,2	13,9	13,6	13,2	12,7	12	11,3	10,5	7,2	-		
NR4 65/250D/B	8,6	5	-	2,2	3	13,7	13,9	13,8	13,8	13,6	13,4	13,1	12,8	12,3	11,6	10,9	10,1	7,2	-		
NR4 65/250C/B	8,6	5	-	2,2	3	17,1	17,3	17,2	17,2	16,9	16,7	16,3	16	15,4	14,7	13,9	13	10	-		
NR4 65/250B/A	11,1	6,4	-	3	4	19,9	20,1	20	20	19,8	19,6	19,3	19	18,4	17,7	16,9	16,1	13,2	10,8		
NR4 65/250A/A	-	8,3	4,8	4	5,5	21,4	21,6	21,5	21,4	21,3	21,1	20,8	20,5	19,9	19,2	18,4	17,6	14,7	12,2		

Three-phase

						Q = Flow												
						m³/h	0	20	25	30	35	40	50	60	70	80	90	100
Model	230V	400V	690V	P2		l/min	333	417	500	583	667	833	1000	1167	1333	1500	1667	1833
	A			kW	HP	H (m) = Total head												
NR4 100C/B	5	2,9	-	1,1	1,5	6,6	6,6	6,4	6,3	6	5,6	4,6	3,3	-	-	-	-	-
NR4 100B/B	5	2,9	-	1,1	1,5	7,5	7,5	7,4	7,2	7	6,6	5,6	4,4	-	-	-	-	-
NR4 100A/B	6	3,5	-	1,5	2	9	9	8,9	8,8	8,6	8,3	7,4	6,2	4,8	-	-	-	-
NR4 125C/B	8,6	5	-	2,2	3	10,2	-	-	10,2	10,1	10	9,6	9	8,2	7,1	5,7	4	-
NR4 125B/A	11,1	6,4	-	3	4	12	-	-	12	11,9	11,8	11,6	11	10,4	9,4	8,2	6,7	5,1
NR4 125A/A	-	8,3	4,8	4	5,5	13,6	-	-	13,6	13,5	13,4	13,2	12,9	12,3	11,4	10,3	8,8	7,2

P1: Maximum power input.

P2: Rated motor power output.

Tolerances according to UNI EN ISO 9906:2012

Coverage chart n ≈ 2900 rpm

Single operation

Three-phase

Model	230V	400V	690V	P2		Q = Flow													
						m³/h	0												
						l/min	15	16,8	18,9	21	24	27	30	33	37,8	39	42	45	
A		kW	HP	H (m) = Total head															
NRD 50/125F	4,6	2,7	-	1,1	1,5	13,7	13,2	12,7	12	11,2	9,9	8,5	6,8	4,8	-	-	-	-	
NRD 50/125C	7,5	4,3	-	1,5	2	17,8	17,8	17,4	16,8	16	14,8	13,3	11,7	9,9	6,8	5,9	-	-	
NRD 50/125A	9,2	5,3	-	2,2	3	20,8	21,2	20,9	20,5	19,9	18,7	17,4	15,8	14,1	11,1	10,4	8,3	-	
NRD 50/160C	9,2	5,3	-	2,2	3	23,4	22,9	22,4	21,7	20,9	19,4	17,7	15,7	13,4	9,1	7,8	-	-	
NRD 50/160B	11,5	6,6	-	3	4	25,6	25	24,6	24	23,3	22	20,4	18,5	16,2	11,9	10,7	7,5	-	
NRD 50/160A	-	9,6	5,5	4	5,5	34	34,6	34,3	33,8	33,2	32	30,5	28,7	26,7	22,8	21,7	18,8	15,6	

Three-phase

Model	230V	400V	690V	P2		Q = Flow													
						m³/h	0												
						l/min	21	24	27	30	33	37,8	42	48	54	60	66	69	72
A		kW	HP	H (m) = Total head															
NRD 65/125F	9,2	5,3	-	2,2	3	16,2	14,9	14,4	13,8	13,2	12,5	11,3	10,1	8,2	6,1	3,9	-	-	-
NRD 65/125D	11,5	6,6	-	3	4	20,4	19,1	18,6	18,1	17,5	16,9	15,7	14,4	12,4	10	7,2	4,3	-	-
NRD 65/125A	-	9,6	5,5	4	5,5	25,3	25	24,7	24,3	23,8	23,2	22,1	21	19,1	16,9	14,3	11,5	9,9	-
NRD 65/160B	-	10,8	6,2	5,5	7,5	30,7	31,3	31,1	30,8	30,4	29,9	28,6	27,2	24,7	21,7	18,2	14,5	12,5	10,4
NRD 65/160A	-	14,3	8,3	7,5	10	37,5	37,7	37,6	37,4	37,1	36,6	35,6	34,4	32,1	29,3	26	22,5	20,6	18,5

Parallel operation

For parallel operation see curve diagram

P1: Maximum power input.

P2: Rated motor power output.

Tolerances according to UNI EN ISO 9906:2012

Performance n ≈ 1450 rpm

Single operation

Three-phase

Model	230V	400V	P2		Q = Flow														
					m³/h	0													
					l/min	5,4	6	7,5	8,4	9,6	10,8	12	13,2	15	16,8	18,9	21	24	27
A		kW	HP	H (m) = Total head															
NRD4 50/160C	1,65	0,95	0,37	0,5	5,9	5,9	5,8	5,7	5,5	5,3	5,1	4,8	4,5	3,9	3,1	2,1	-	-	-
NRD4 50/160B	2,6	1,5	0,55	0,75	7,3	7,5	7,5	7,4	7,3	7,1	6,8	6,6	6,3	5,7	5,1	4,1	3	1,3	-
NRD4 50/160A	3,3	1,9	0,75	1	9,3	9,5	9,5	9,4	9,3	9,2	9,1	8,9	8,6	8,1	7,6	6,8	5,8	4,1	2,1

Three-phase

Model	230V	400V	P2		Q = Flow													
					m³/h	0												
					l/min	10,8	12	13,2	15	16,8	18,9	21	24	27	30	33	37,8	42
A		kW	HP	H (m) = Total head														
NRD4 65/125F	1,65	0,95	0,37	0,5	4,3	4,1	4	3,9	3,7	3,5	3,3	3	2,5	2	1,3	-	-	-
NRD4 65/125D	2,6	1,5	0,55	0,75	5,4	5,2	5,1	5	4,9	4,7	4,4	4,1	3,6	3,1	2,5	1,7	-	-
NRD4 65/125A	3,3	1,9	0,75	1	6,5	6,4	6,3	6,3	6,1	6	5,8	5,5	5	4,4	3,8	3,1	2	-
NRD4 65/160B	5	2,9	1,1	1,5	8,1	8,2	8,2	8,1	8	7,9	7,6	7,3	6,7	6	5,1	4,1	2,5	-
NRD4 65/160A	5	2,9	1,1	1,5	9,8	9,8	9,8	9,7	9,6	9,4	9,2	8,9	8,3	7,7	6,9	6	4,3	2,6

Parallel operation

For parallel operation see curve diagram

P1: Maximum power input.

P2: Rated motor power output.

Tolerances according to UNI EN ISO 9906:2012

NR(D)(EI), NR(D)4(EI)



Coverage chart $n \approx 2900$ rpm

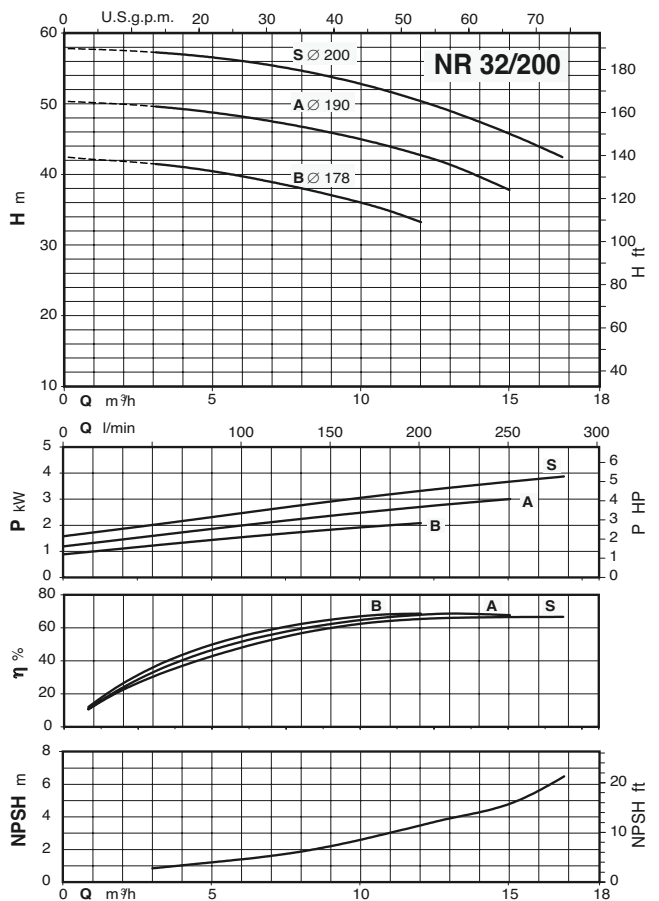
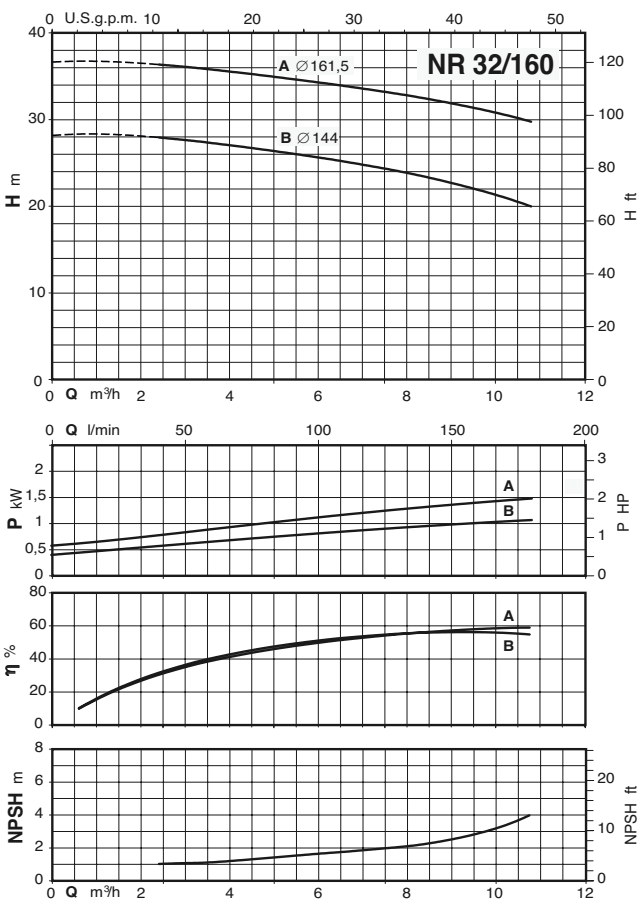
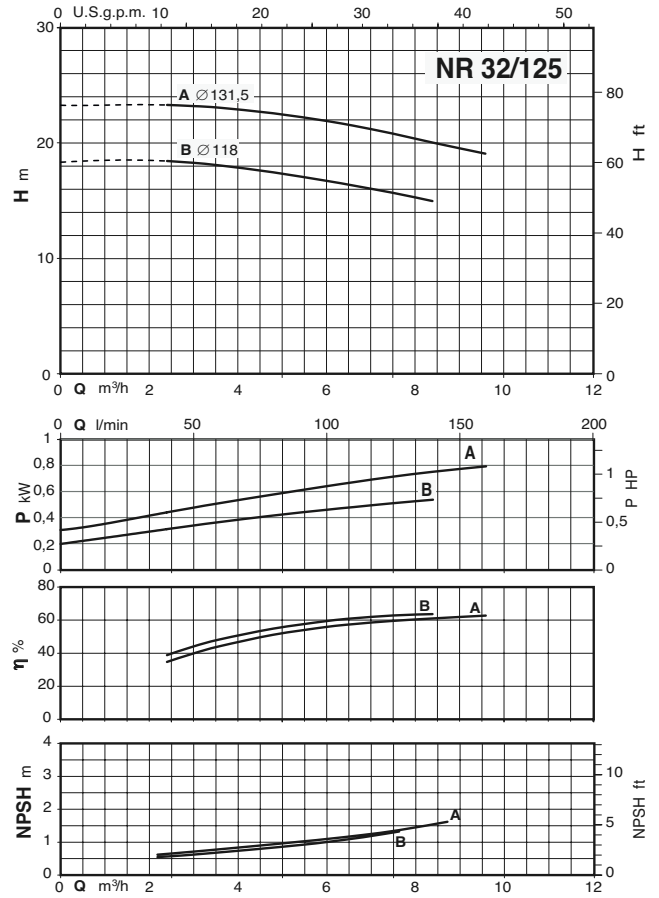
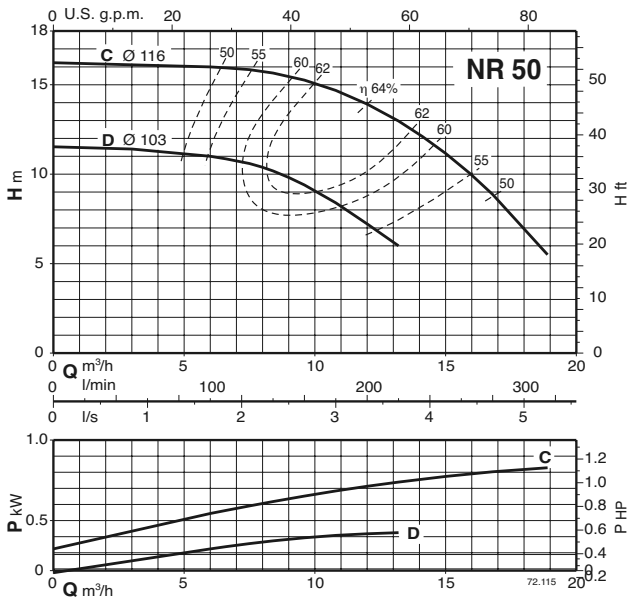

NR(D)(EI), NR(D)4(EI)



Coverage chart $n \approx 2900$ rpm

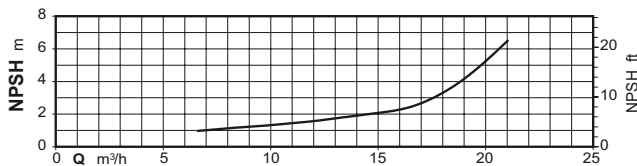
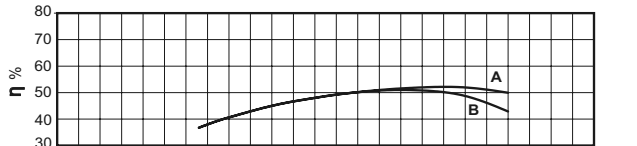
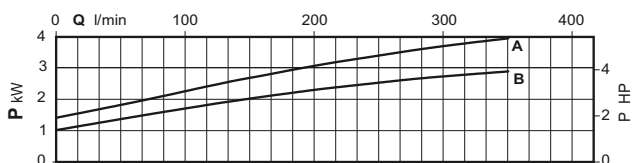
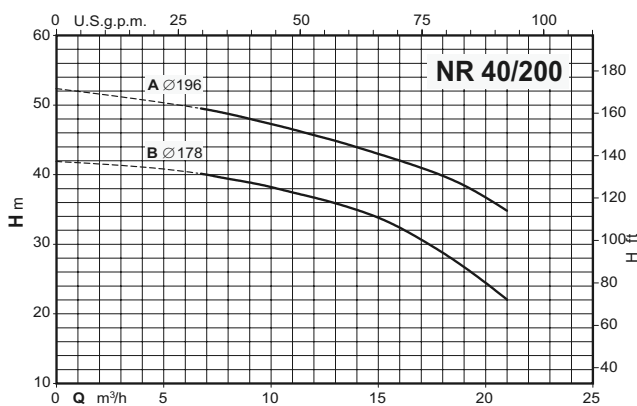
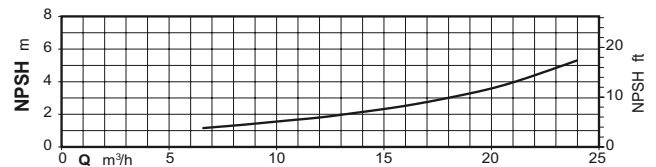
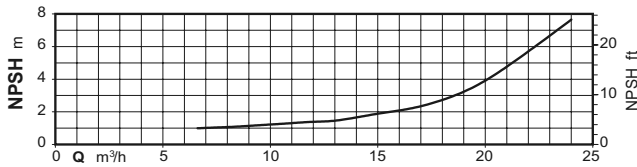
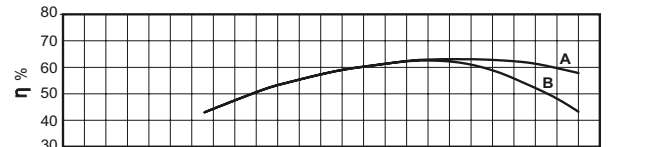
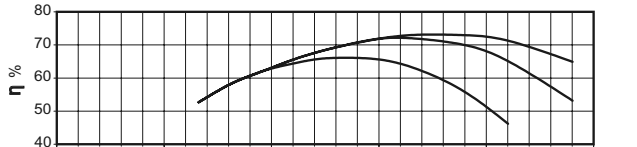
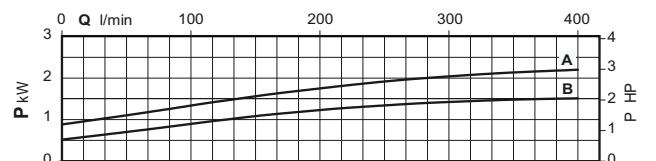
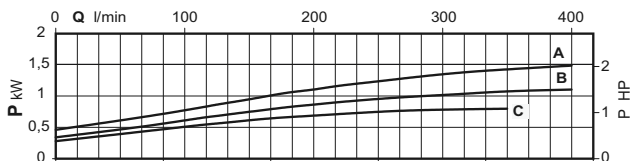
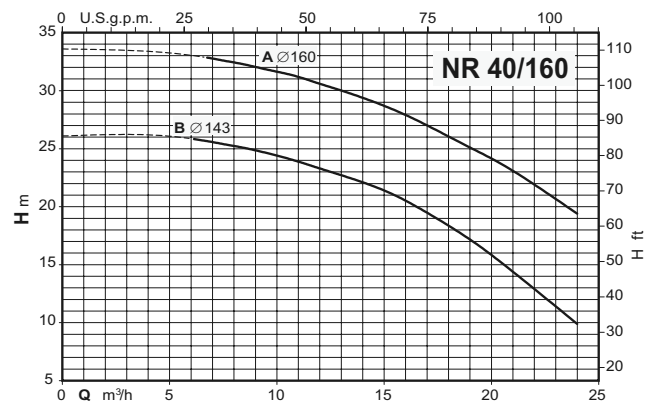
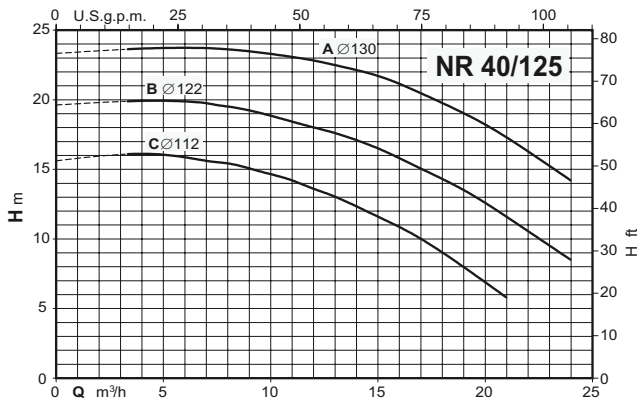

NR(D)(EI), NR(D)4(EI)



Coverage chart $n \approx 2900$ rpm

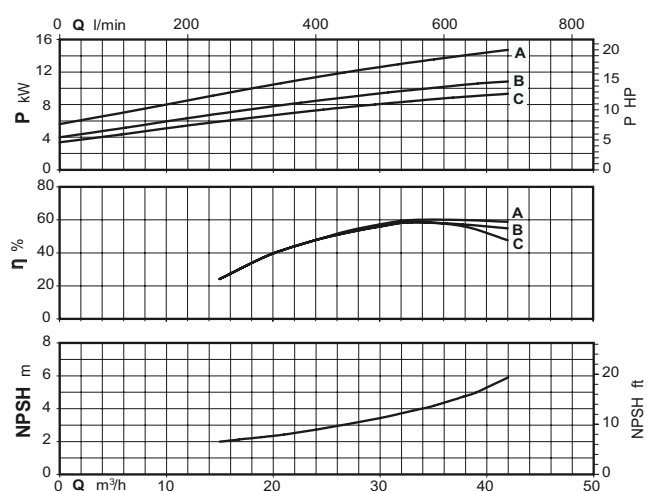
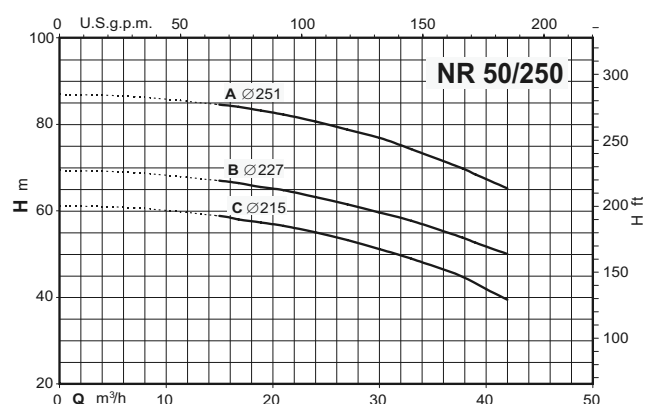
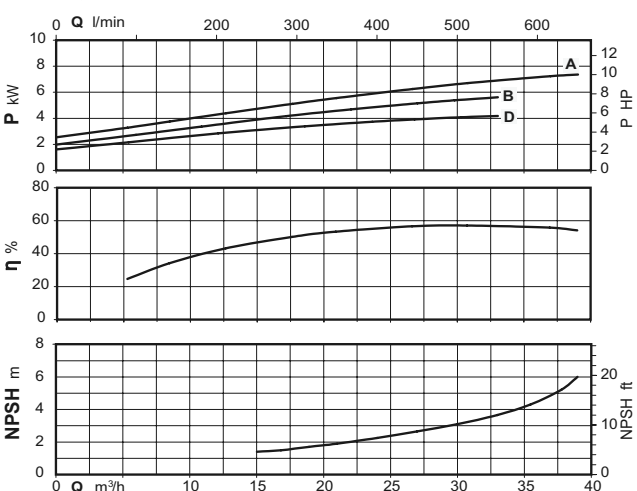
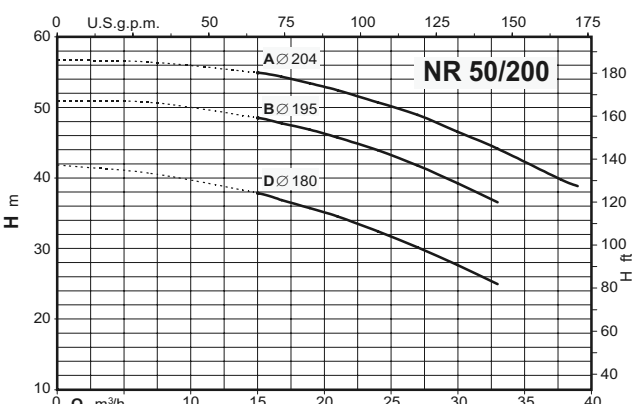
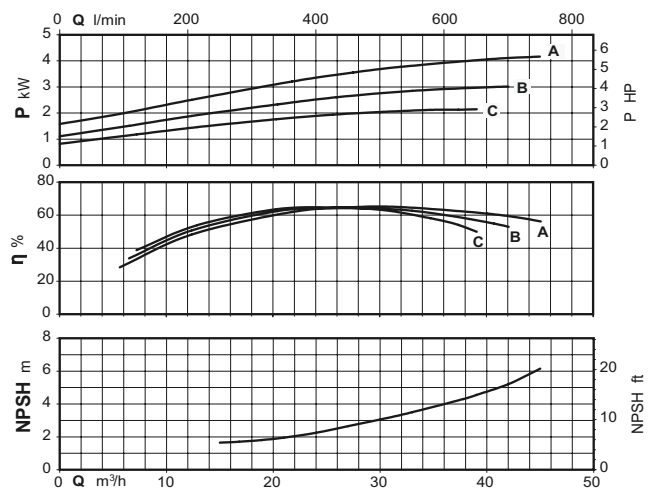
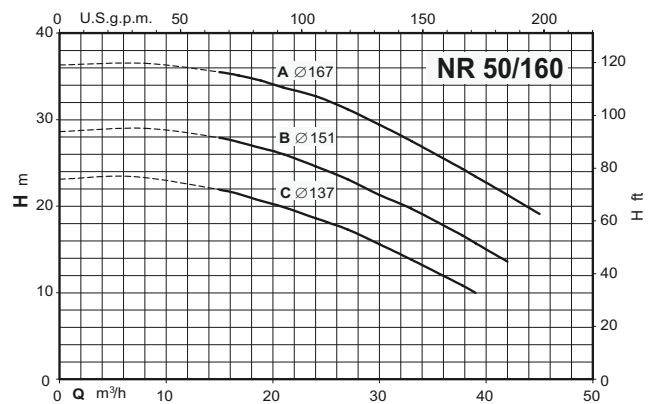
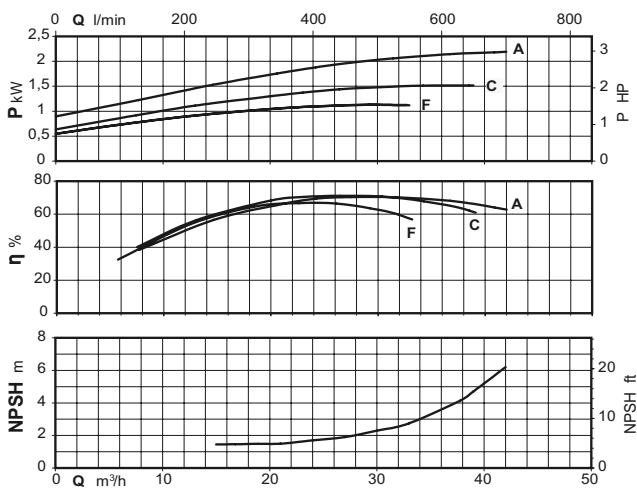
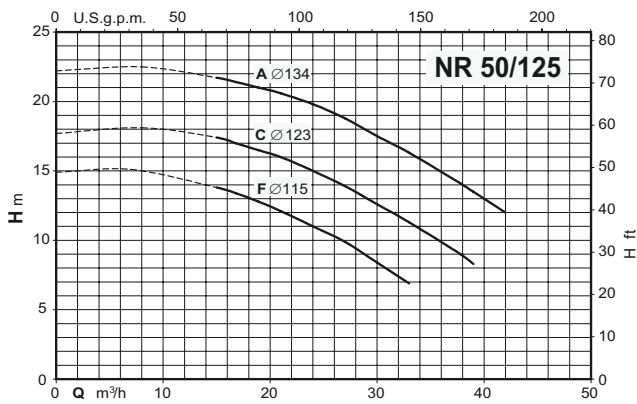

NR(D)(EI), NR(D)4(EI)



Coverage chart $n \approx 2900$ rpm

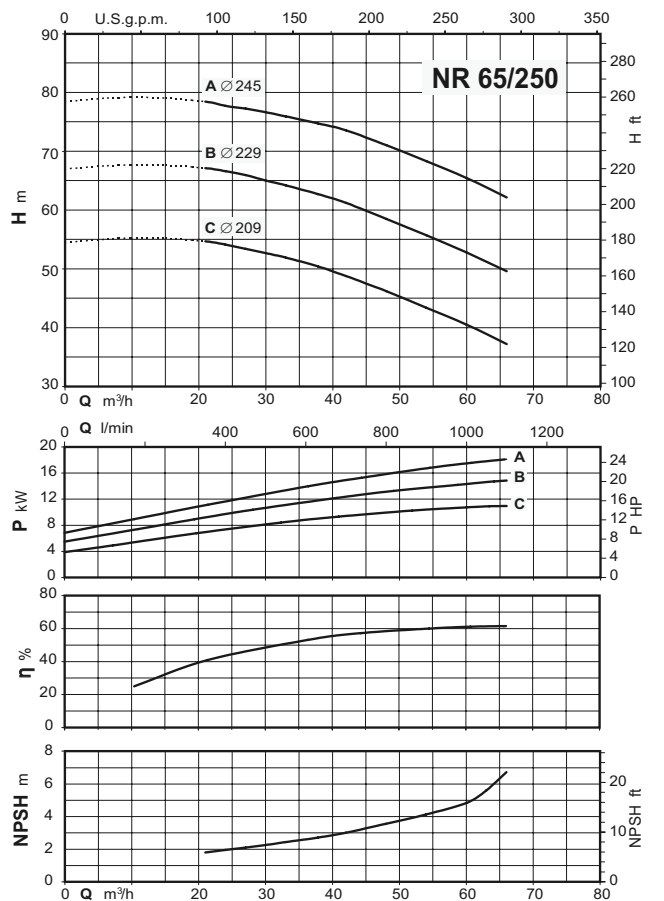
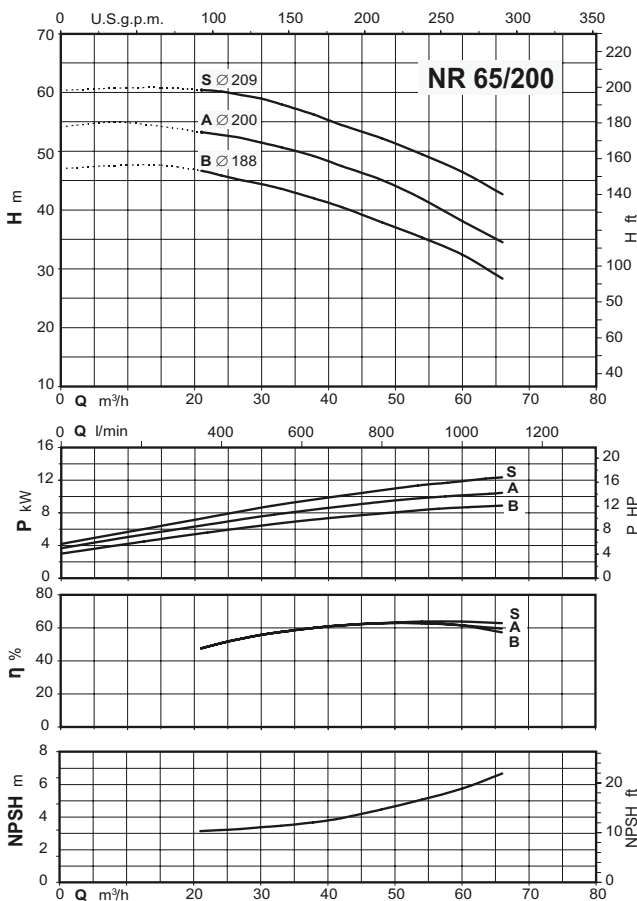
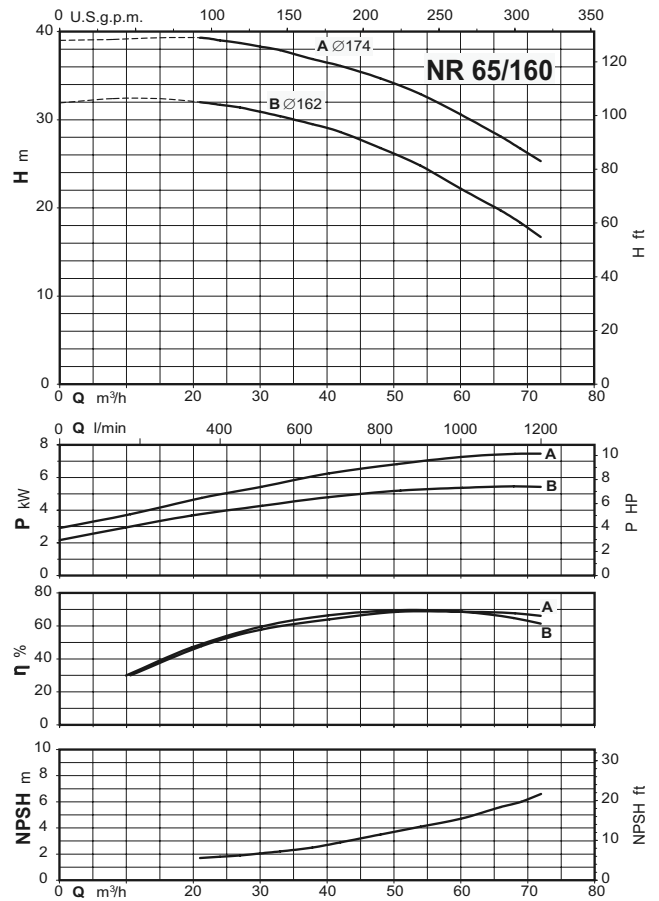
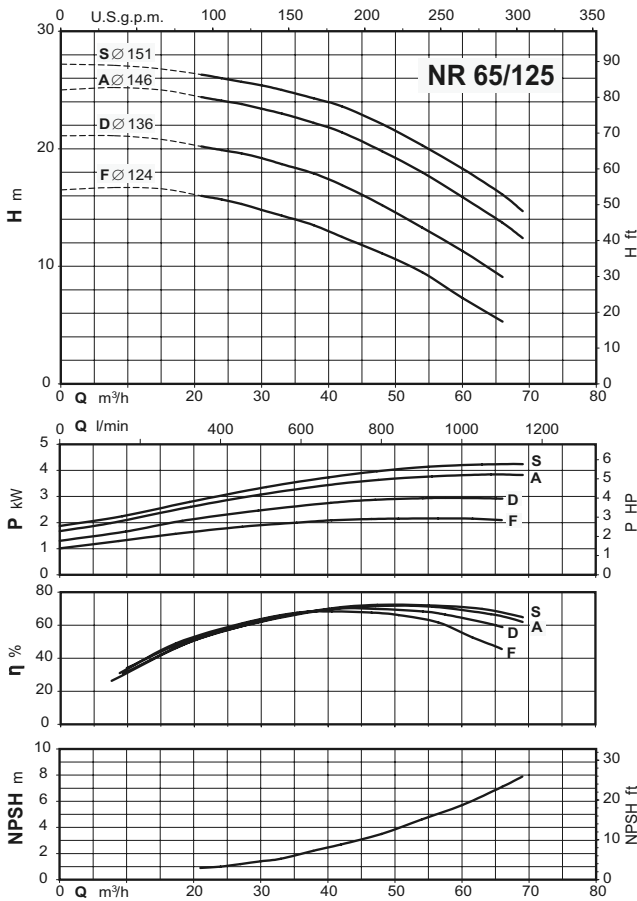

NR(D)(EI), NR(D)4(EI)



Coverage chart $n \approx 2900$ rpm

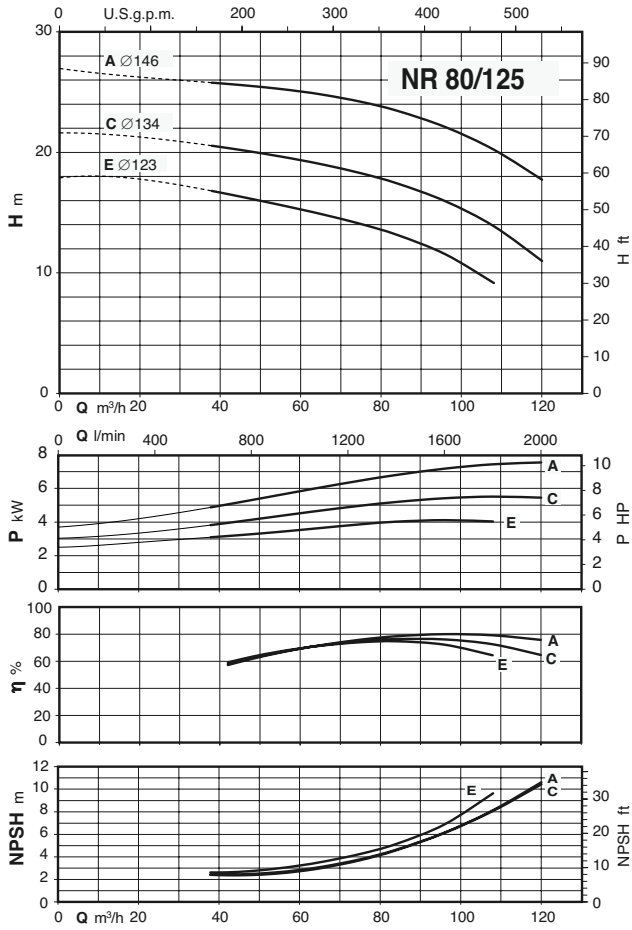

NR(D)(EI), NR(D)4(EI)



Coverage chart $n \approx 1450$ rpm

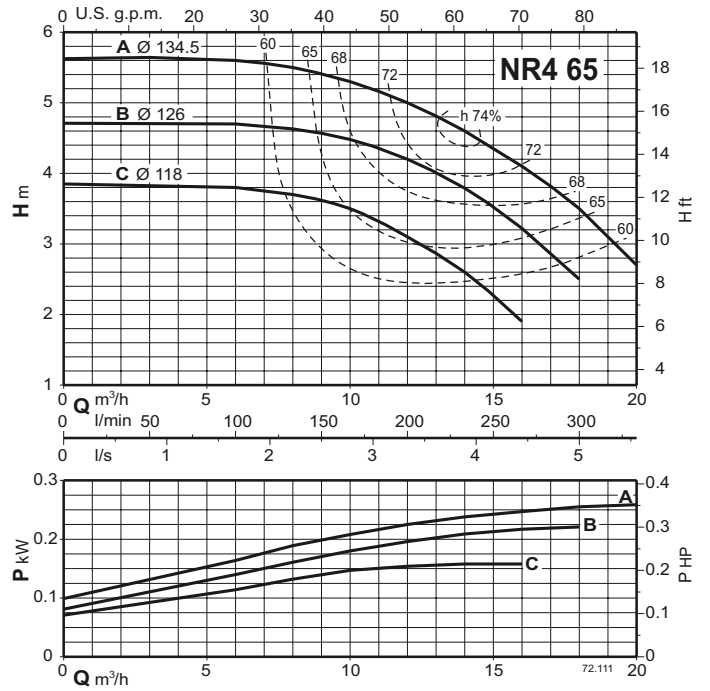
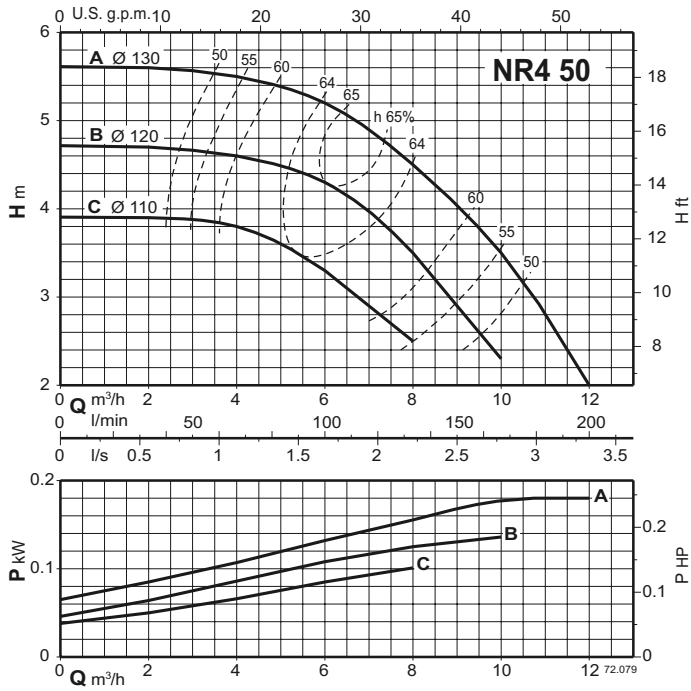

NR(D)(EI), NR(D)4(EI)



Coverage chart $n \approx 1450$ rpm

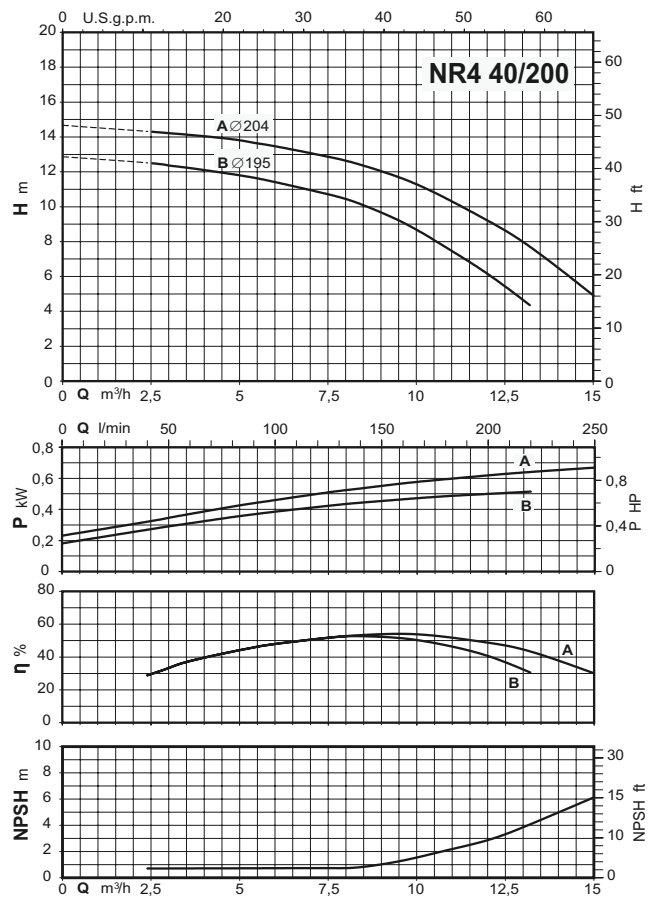
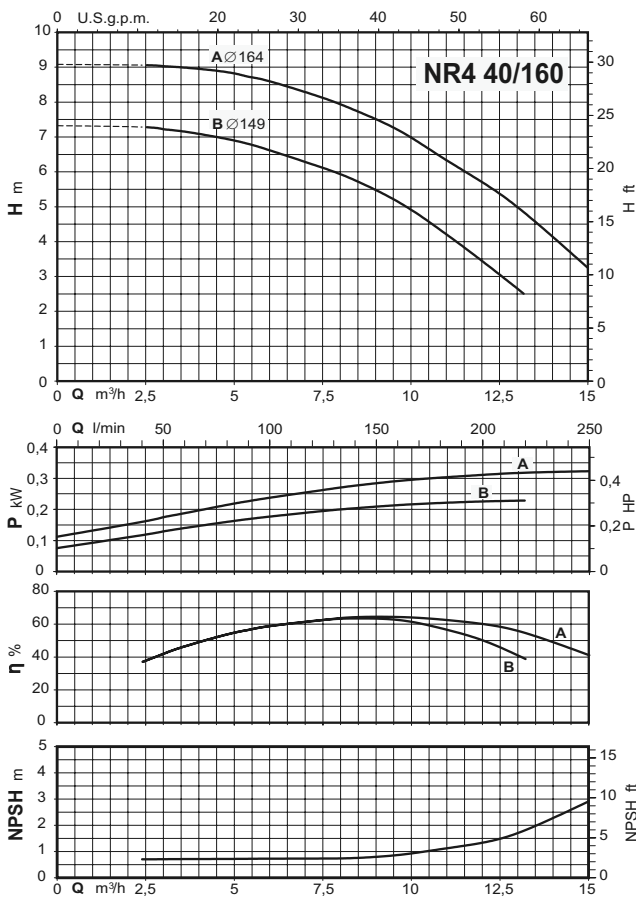
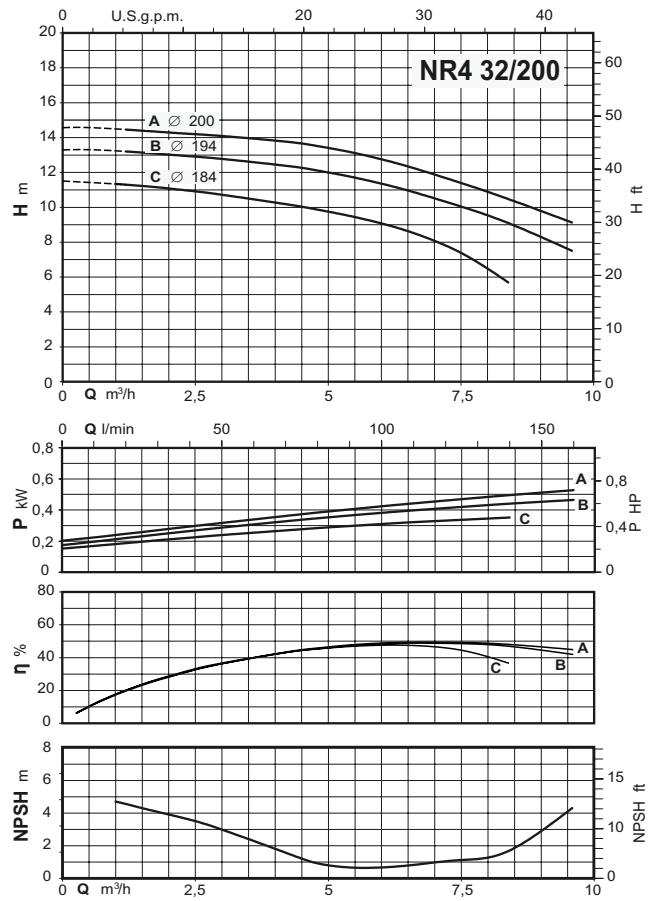
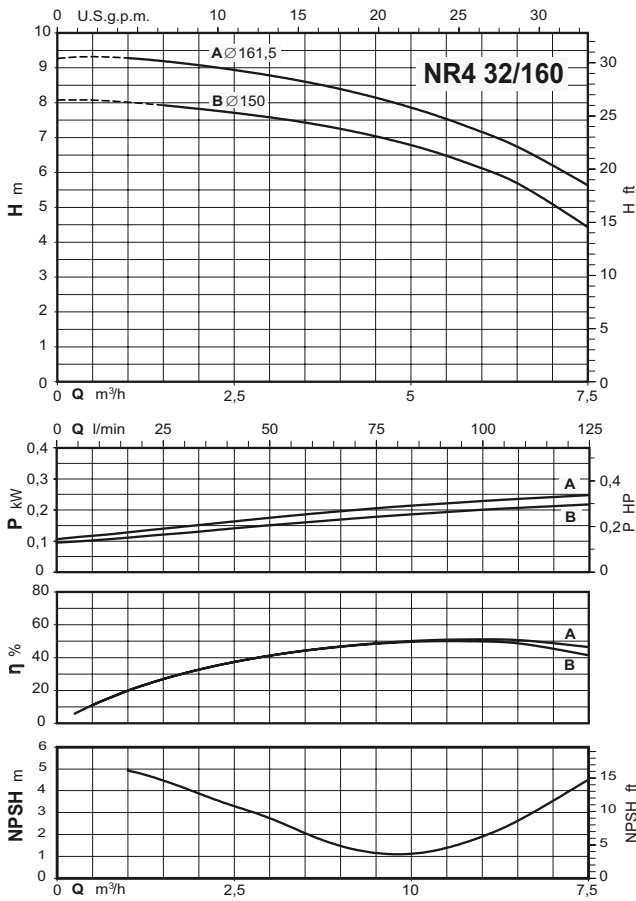

NR(D)(EI), NR(D)4(EI)



Coverage chart $n \approx 1450$ rpm

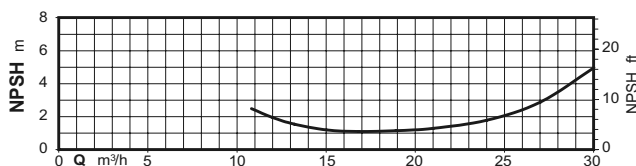
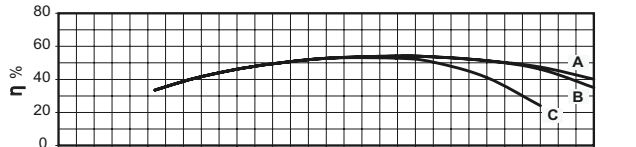
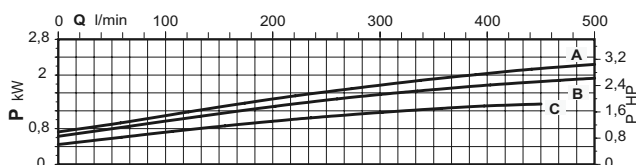
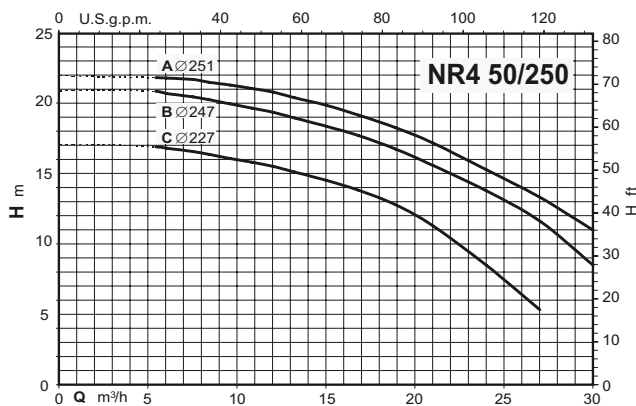
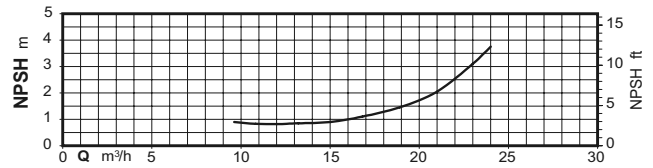
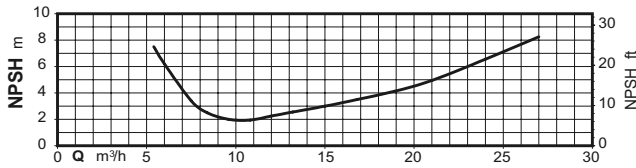
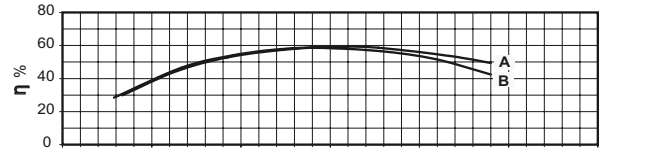
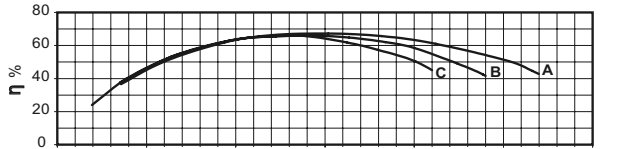
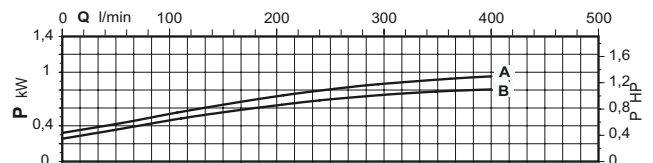
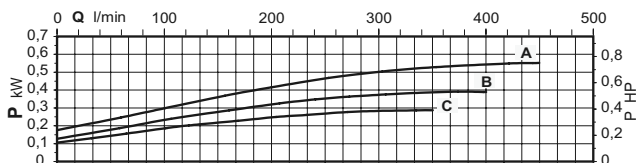
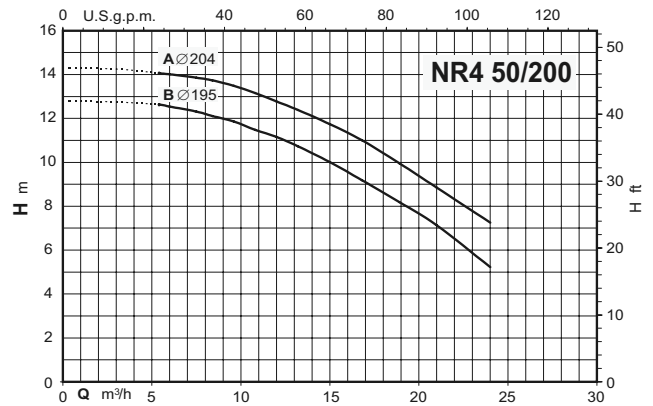
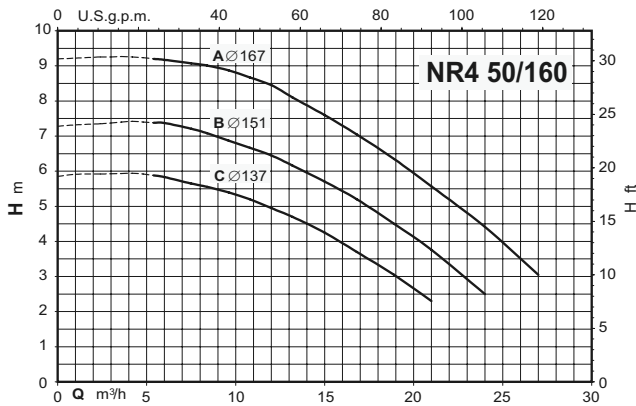

NR(D)(EI), NR(D)4(EI)



Coverage chart $n \approx 1450$ rpm

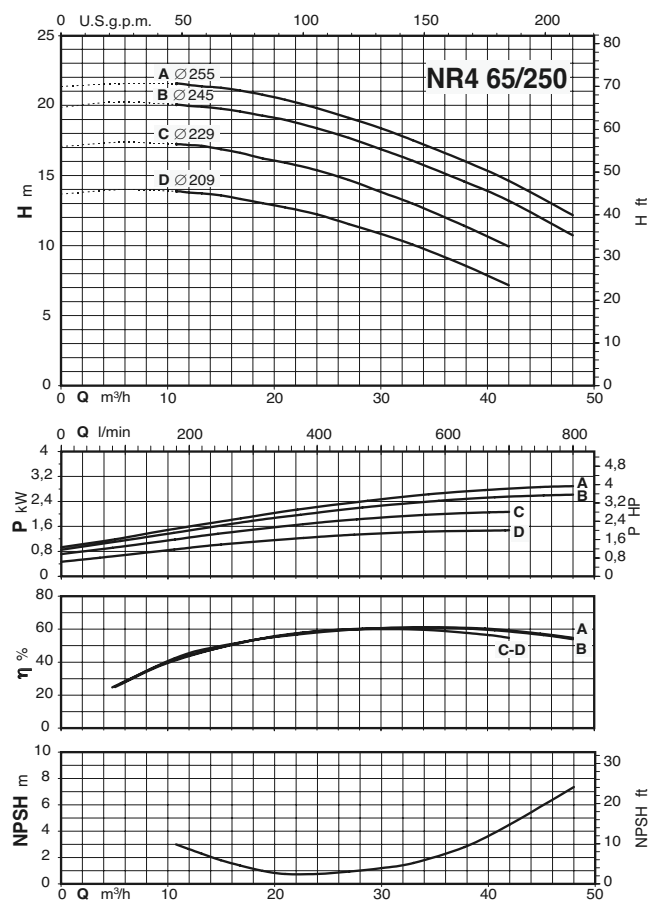
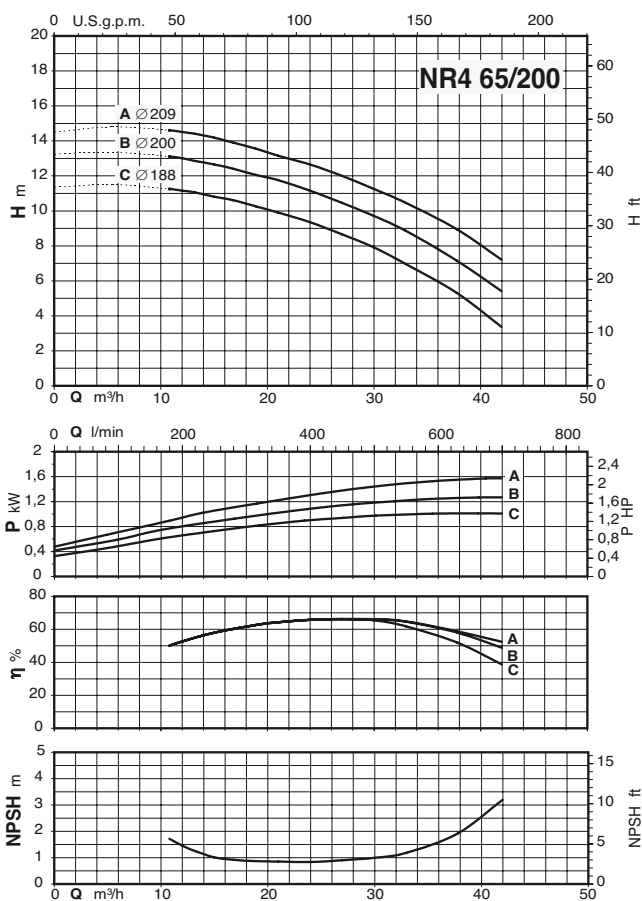
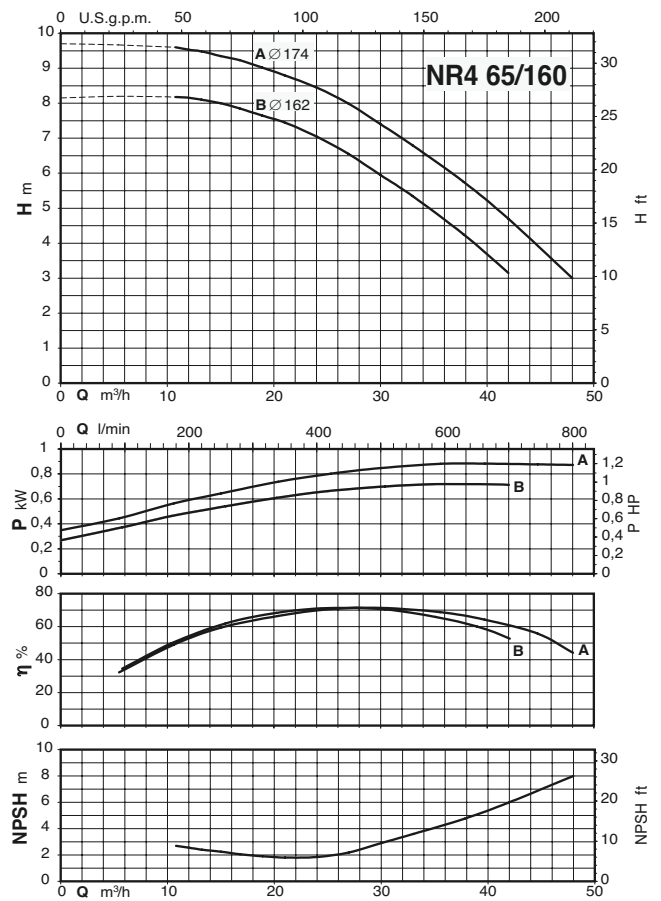
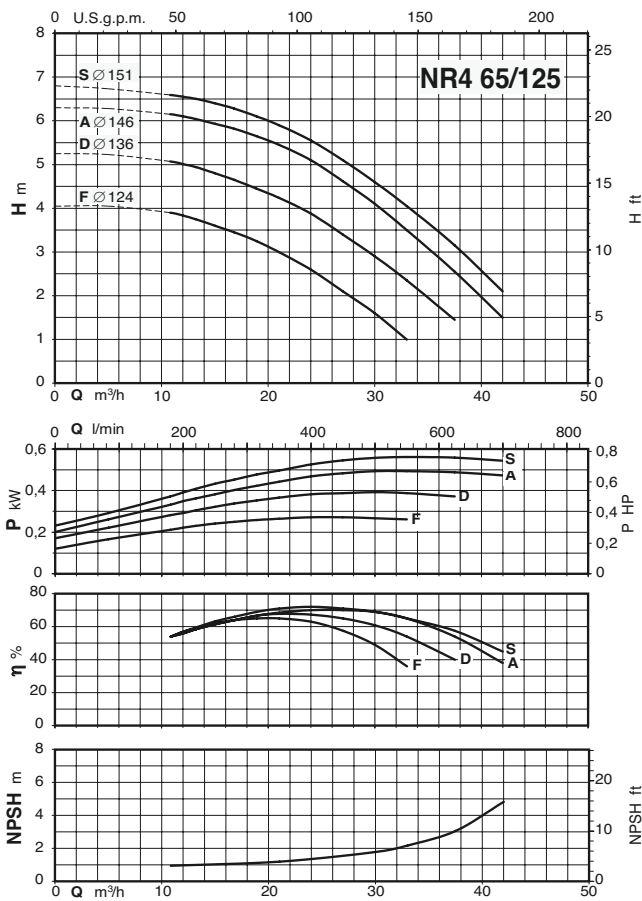

NR(D)(EI), NR(D)4(EI)



Coverage chart $n \approx 1450$ rpm

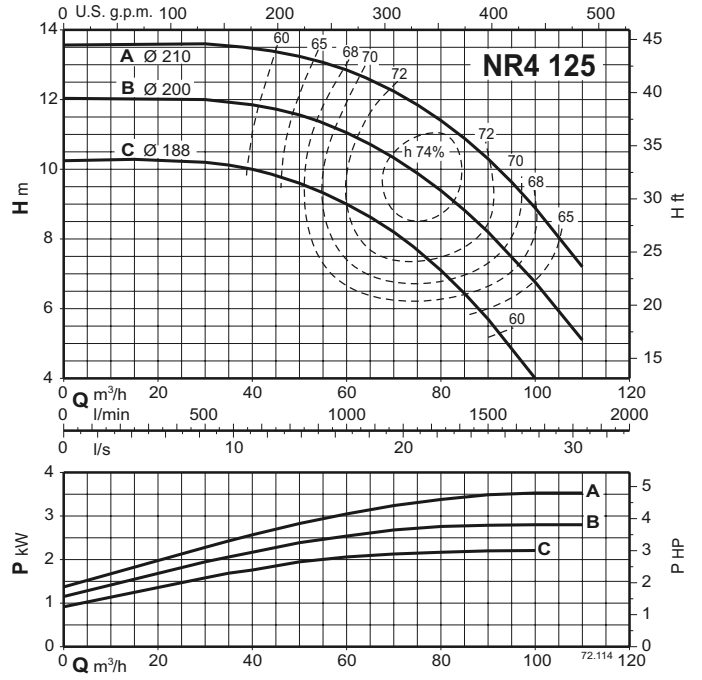
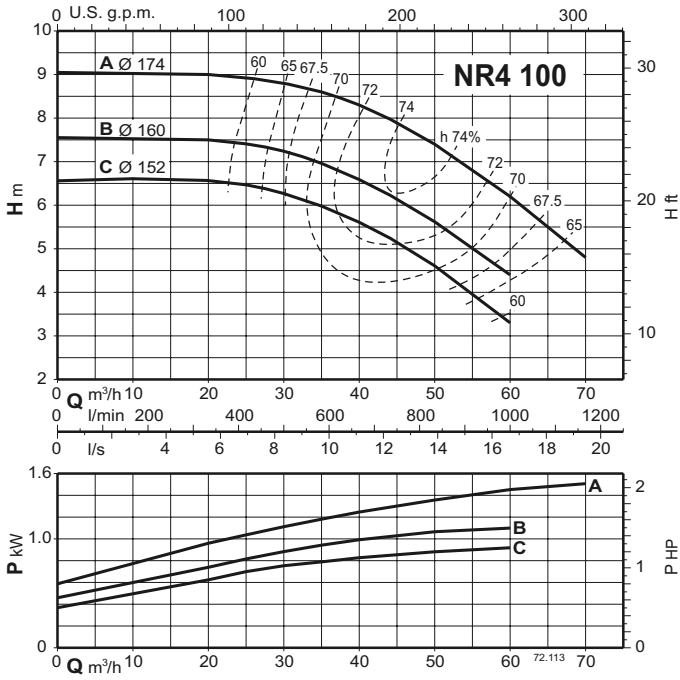

NR(D)(EI), NR(D)4(EI)



Coverage chart $n \approx 2900$ rpm

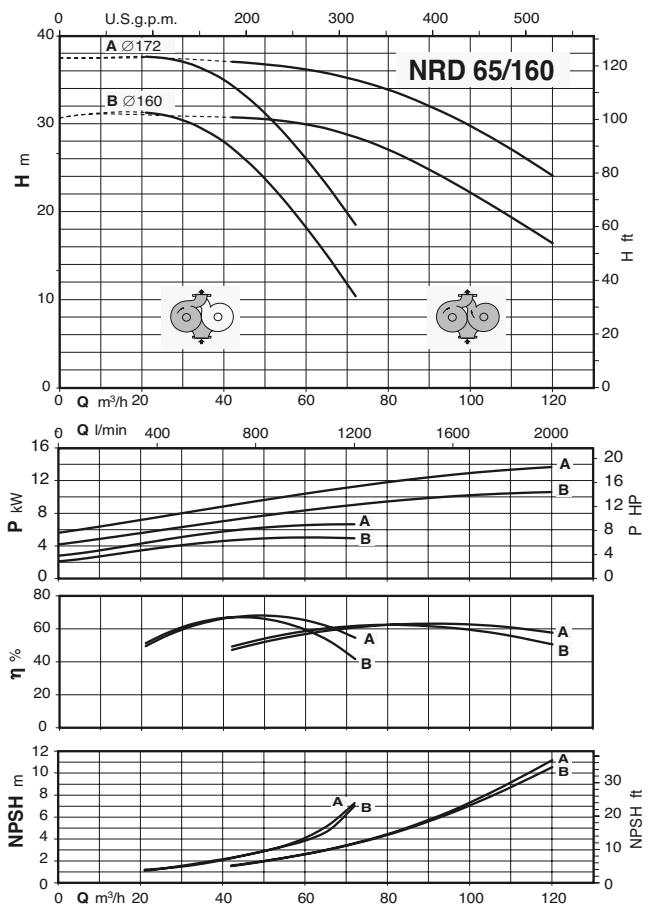
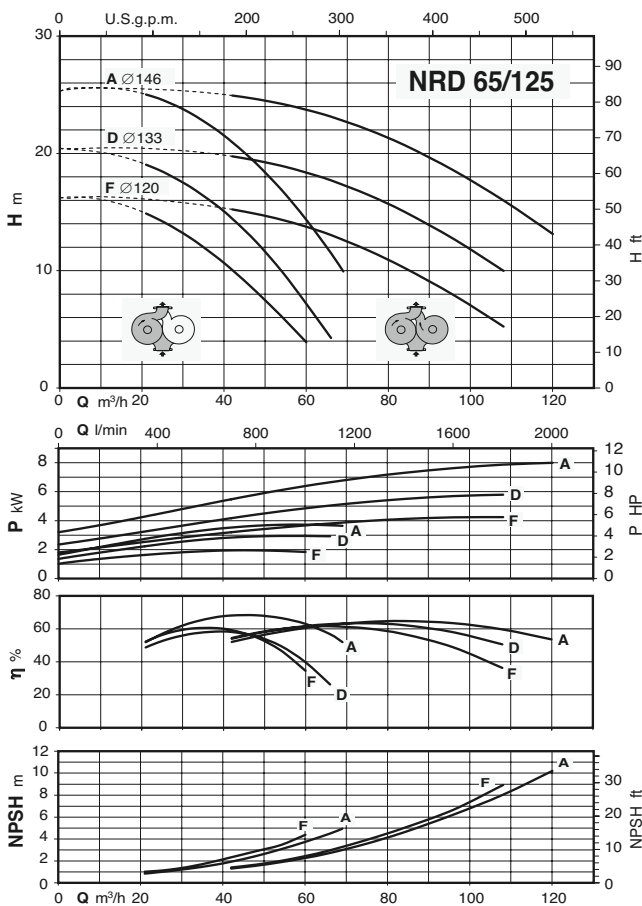
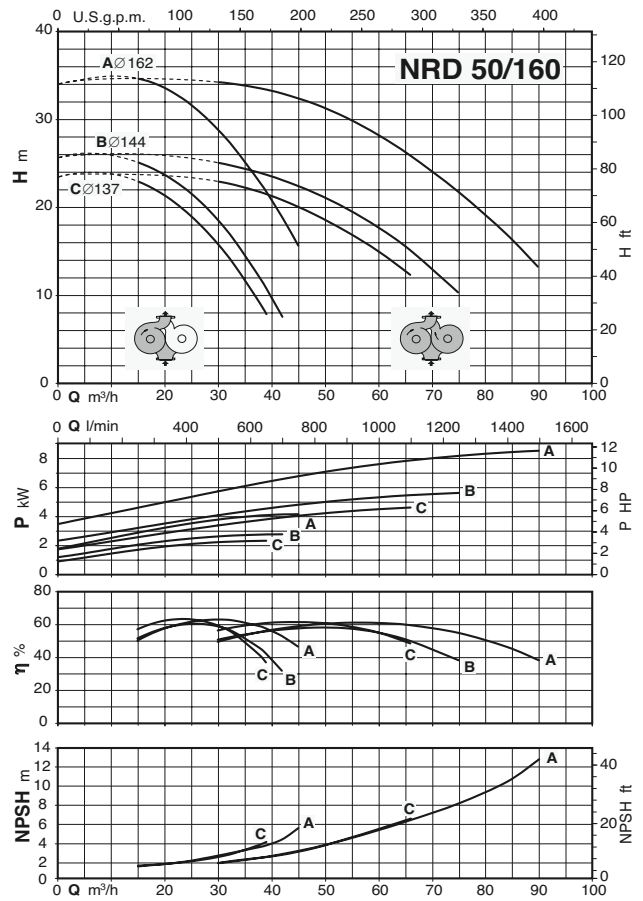
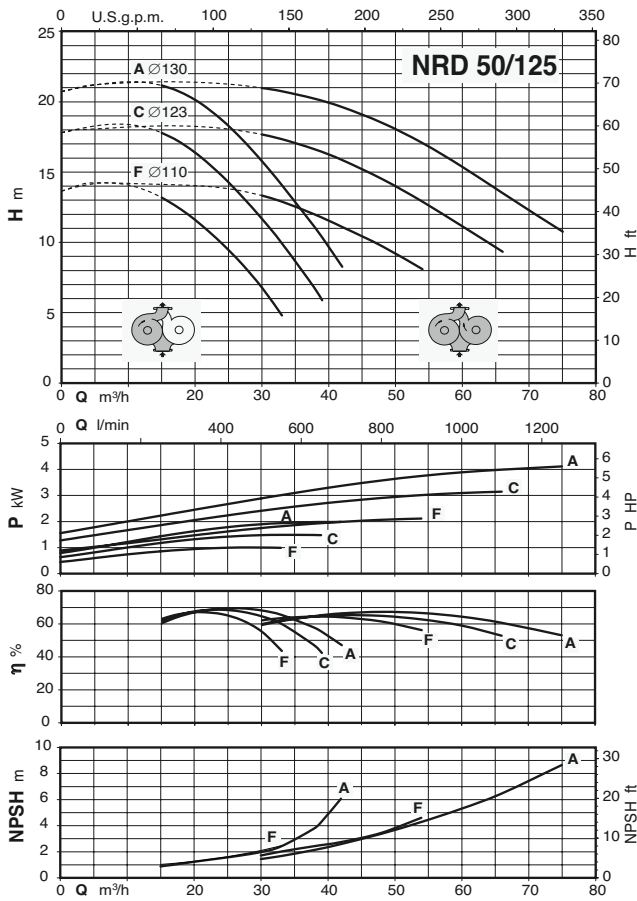

NR(D)(EI), NR(D)4(EI)



Coverage chart $n \approx 1450$ rpm

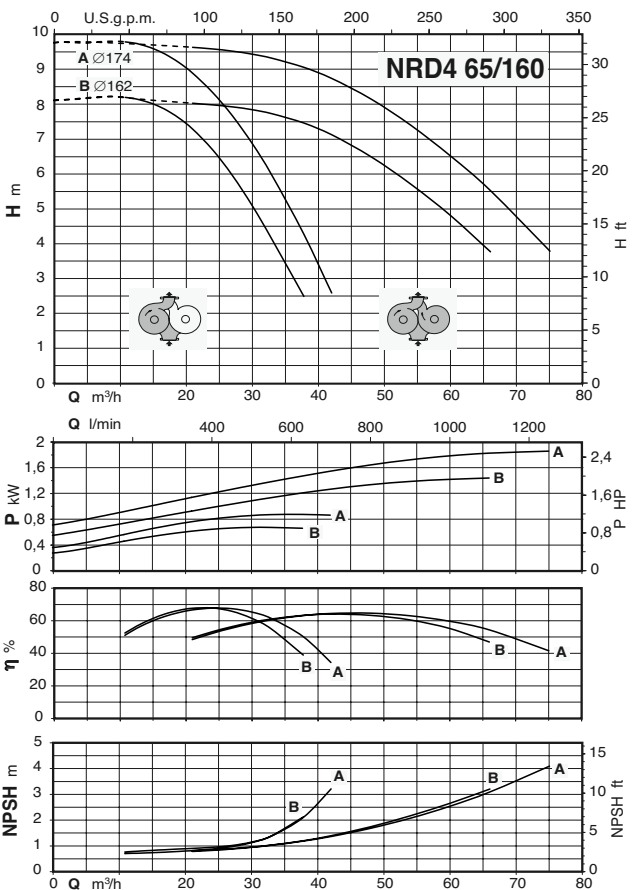
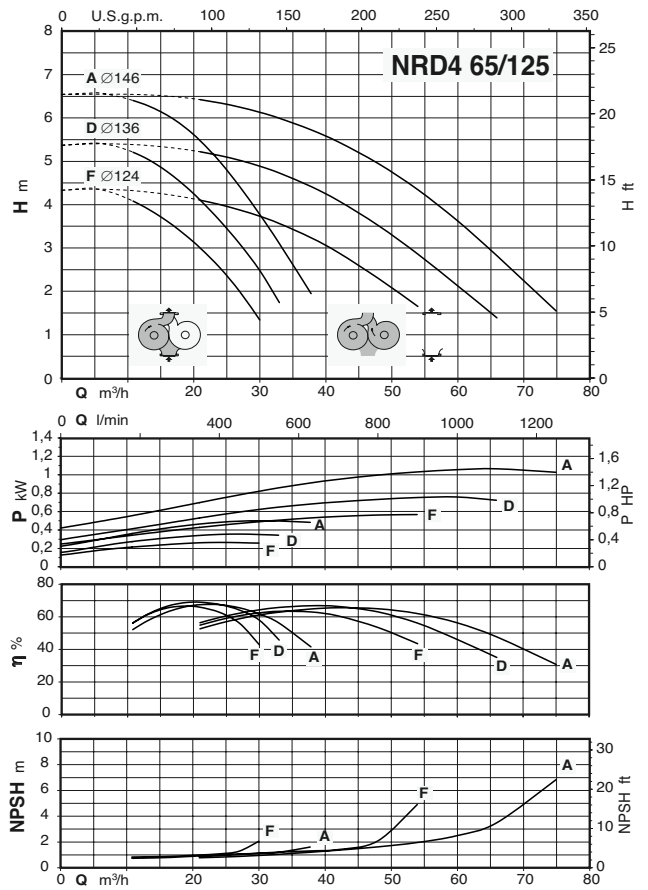
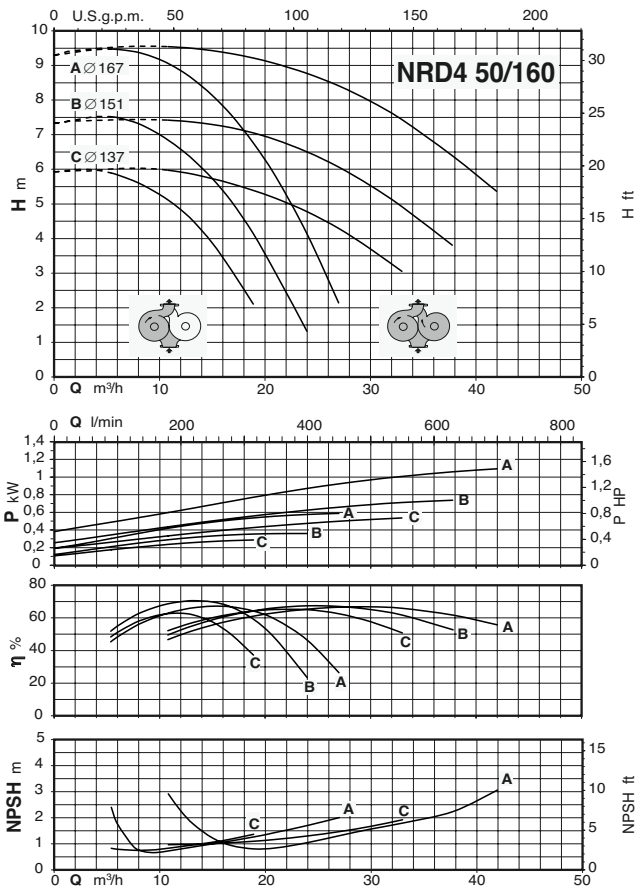

Dimensions and weights

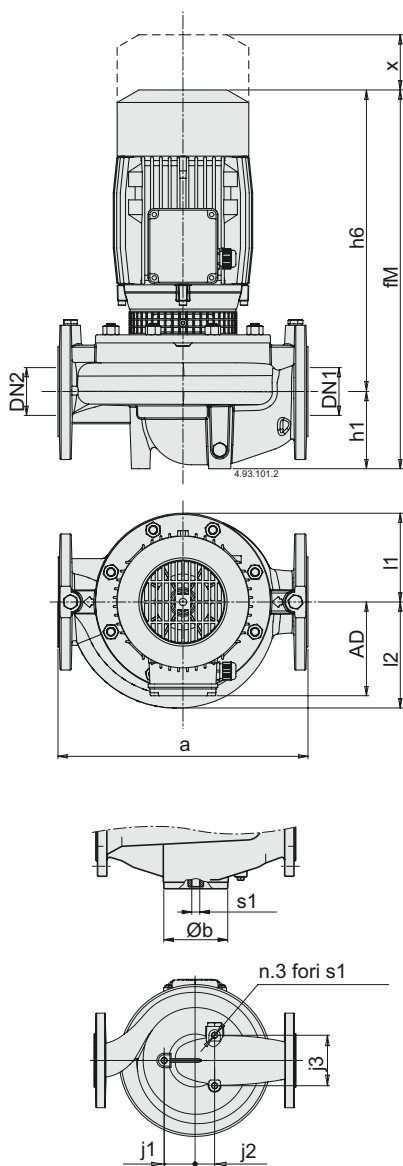

TYPE			mm													kg
	DN1	DN2	a	AD	b	fM	h1	h6	j1	j2	j3	l1	l2	s1	x	Weight
NR 50D/A	50	50	320	111	98	363.5	90	273.5	-	-	-	93	100	M16	70	20.8
NR 50C/B	50	50	320	111	98	363.5	90	273.5	-	-	-	93	100	M16	70	23.8
NR 32/125B	32	32	260	111	-	351	80	271	49.5	31.5	70.5	86	88	M10	60	18.9
NR 32/125A	32	32	260	111	-	351	80	271	49.5	31.5	70.5	86	88	M10	60	19
NR 32/160B/A	32	32	340	128	-	421	80	341	50	40	76	102	102	M10	60	26.1
NR 32/160A/A	32	32	340	128	-	421	80	341	50	40	76	102	102	M10	60	27.8
NR 32/200B/A	32	32	440	128	-	469	85	384	60	44	84	126	126	M10	60	36.7
NR 32/200A	32	32	440	138	-	495	85	410	60	44	84	126	126	M10	60	44
NR 32/200S/A	32	32	440	138	-	495	85	410	60	44	84	126	126	M10	60	46.7
NR 40/125C	40	40	320	128	-	423	81	342	49	31	80	93	98	M10	70	25.7
NR 40/125B/A	40	40	320	128	-	423	81	342	49	31	80	93	98	M10	70	27.3
NR 40/125A/A	40	40	320	128	-	423	81	342	49	31	80	93	98	M10	70	28.6
NR 40/160B/A	40	40	320	128	-	430	81	349	49	31	80	119	119	M10	75	35.6
NR 40/160A/A	40	40	320	128	-	470	81	389	49	31	80	119	119	M10	75	39.1
NR 40/200B	40	40	440	138	-	496	81	415	62	40	95	140	140	M10	75	53.4
NR 40/200A/A	40	40	440	138	-	496	81	415	62	40	95	140	140	M10	75	56.6
NR 50/125C/A	50	50	340	128	-	437	90	347	45	40	79	96	115	M10	75	30.4
NR 50/125A/A	50	50	340	128	-	437	90	347	45	40	79	96	115	M10	75	31.9
NR 50/125A/B	50	50	340	128	-	477	90	387	45	40	79	96	115	M10	75	35.3
NR 50/160C/B	50	50	340	128	-	480	90	390	45	40	79	120	128	M10	75	38.4
NR 50/160B/A	50	50	340	138	-	506	90	416	45	40	79	120	128	M10	75	47
NR 50/160A/B	50	50	340	138	-	506	90	416	45	40	79	120	128	M10	75	50.4
NR 50/200D/B	50	50	440	138	-	515	100	415	45	40	79	140	140	M10	80	57.3
NR 50/200B/A	50	50	440	159	-	544	100	444	45	40	79	140	140	M10	80	70.1
NR 50/200A/A	50	50	440	159	-	544	100	444	45	40	79	140	140	M10	80	73
NR 50/250C/B	50	50	440	190	-	656	100	556	45	40	79	175	175	M10	85	-
NR 50/250B/A	50	50	440	190	-	656	100	556	45	40	79	175	175	M10	85	119.5
NR 50/250A/B	50	50	440	190	-	731	100	631	45	40	79	175	175	M10	85	139.4
NR 65/125F/B	65	65	340	128	-	494	105	389	60	50	110	121	145	M10	95	43.7
NR 65/125D/A	65	65	340	138	-	519	105	414	60	50	110	121	145	M10	95	52.1
NR 65/125A/B	65	65	340	138	-	519	105	414	60	50	110	121	145	M10	95	55
NR 65/125S/B	65	65	340	138	-	519	105	414	60	50	110	121	145	M10	95	55.3
NR 65/160B/A	65	65	340	159	-	552	105	447	60	50	110	121	142	M10	95	67.4
NR 65/160A/A	65	65	340	159	-	552	105	447	60	50	110	121	142	M10	95	73.3
NR 65/200B/B	65	65	475	190	-	666	105	561	60	50	110	140	153	M10	90	109.2
NR 65/200A/A	65	65	475	190	-	666	105	561	60	50	110	140	153	M10	90	117.4
NR 65/200S/B	65	65	475	190	-	741	105	636	60	50	110	140	153	M10	90	136.7
NR 65/250C/A	65	65	475	190	-	670	105	565	60	50	110	175	175	M10	90	-
NR 65/250B/B	65	65	475	190	-	745	105	640	60	50	110	175	175	M10	90	152.8
NR 65/250A/C	65	65	475	208	-	791	105	686	60	50	110	175	175	M10	90	172.6
NR 80/125E	80	80	440	138	-	534	105	429	85	42.5	147	129	152	M10	105	-
NR 80/125C	80	80	440	166	-	595	105	490	85	42.5	147	129	152	M10	105	-
NR 80/125A	80	80	440	166	-	595	105	490	85	42.5	147	129	152	M10	105	79.2

TYPE			mm													kg
	DN1	DN2	a	AD	fM	h1	h6	j1	j2	j3	l1	l2	s1	x	Weight	
NRM 40/125C	40	40	320	128	423	81	342	49	31	80	93	98	M10	70	-	
NRM 40/125B	40	40	320	128	423	81	342	49	31	80	93	98	M10	70	-	
NRM 40/125A	40	40	320	128	423	81	342	49	31	80	93	98	M10	70	29	
NRM 40/160B	40	40	320	128	430	81	349	49	31	80	119	119	M10	75	-	
NRM 50/125F	50	50	340	128	437	90	347	45	40	79	96	115	M10	75	-	
NRM 50/125C	50	50	340	128	437	90	347	45	40	79	96	115	M10	75	-	

Flanges EN 1092-2

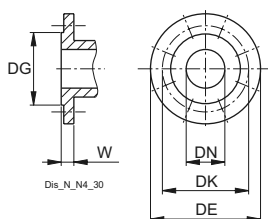

DN	PN	DG	DK	DE	mm		W
					Holes		
					N°	ø	
32	10-16	76	100	140	4	19	18
40	10-16	84	110	150	4	19	18
50	10-16	99	125	165	4	19	20
65	10-16	118	145	185	4	19	20
80	10-16	132	160	200	8	19	22
100	10-16	156	180	220	8	19	24
125	10-16	184	210	250	8	19	24

NR(D)(E), NR(D)4(E)



Dimensions and weights

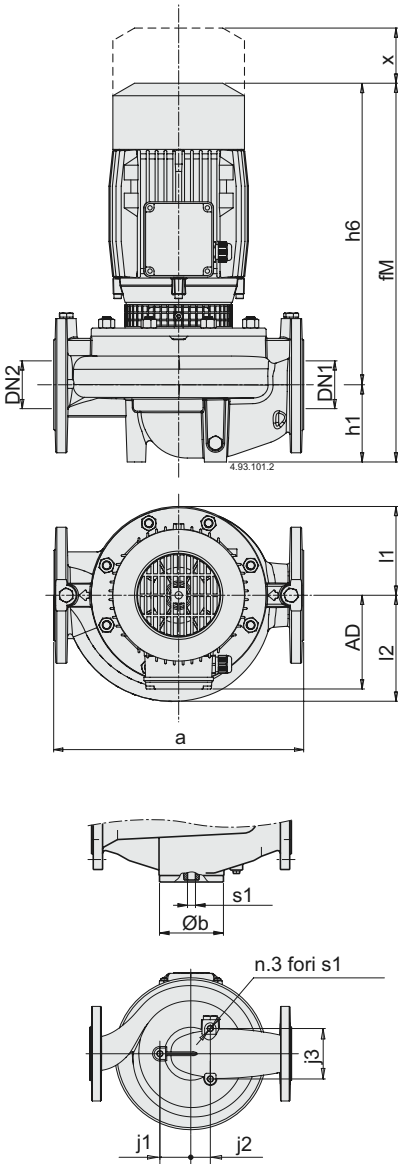

TYPE			mm													kg
	DN1	DN2	a	AD	b	fM	h1	h6	j1	j2	j3	l1	l2	s1	x	Weight
NR4 50C/A	50	50	320	111	98	363.5	90	273.5	-	-	-	93	100	M16	70	22
NR4 50B/A	50	50	320	111	98	363.5	90	273.5	-	-	-	93	100	M16	70	22
NR4 50A/A	50	50	320	111	98	363.5	90	273.5	-	-	-	93	100	M16	70	22.8
NR4 65C/A	65	65	360	111	118	373.5	100	273.5	-	-	-	102	114	M16	70	25
NR4 65B/A	65	65	360	111	118	373.5	100	273.5	-	-	-	102	114	M16	70	26.6
NR4 65A/A	65	65	360	111	118	373.5	100	273.5	-	-	-	102	114	M16	70	26.9
NR4 100C/B	100	100	500	138	162	548	150	398	-	-	-	153	173	M16	105	66.6
NR4 100B/B	100	100	500	138	162	548	150	398	-	-	-	153	173	M16	105	67
NR4 100A/B	100	100	500	138	162	548	150	398	-	-	-	153	173	M16	105	70.5
NR4 125C/B	125	125	600	159	194	608	170	438	-	-	-	172	195	M16	120	98.5
NR4 125B/A	125	125	600	159	194	608	170	438	-	-	-	172	195	M16	120	99
NR4 125A/A	125	125	600	159	194	608	170	438	-	-	-	172	195	M16	120	107
NR4 32/160B/A	32	32	340	128	-	421	80	341	50	40	76	102	102	M10	60	24.1
NR4 32/160A/A	32	32	340	128	-	421	80	341	50	40	76	102	102	M10	60	24.1
NR4 32/200C/A	32	32	440	128	-	426	85	341	60	44	84	126	126	M10	60	29.7
NR4 32/200B/A	32	32	440	128	-	426	85	341	60	44	84	126	126	M10	60	31.5
NR4 32/200A/A	32	32	440	128	-	466	85	381	60	44	84	126	126	M10	60	36.8
NR4 40/160B/A	40	40	320	128	-	430	81	349	49	31	80	119	119	M10	75	30.5
NR4 40/160A/A	40	40	320	128	-	430	81	349	49	31	80	119	119	M10	75	31.2
NR4 40/200B/A	40	40	440	128	-	430	81	349	62	40	95	140	140	M10	75	40.3
NR4 40/200A/A	40	40	440	128	-	470	81	389	62	40	95	140	140	M10	75	46.2
NR4 50/160C	50	50	340	128	-	440	90	350	45	40	79	120	128	M10	75	32.3
NR4 50/160B	50	50	340	128	-	440	90	350	45	40	79	120	128	M10	75	33.8
NR4 50/160A/B	50	50	340	128	-	480	90	390	45	40	79	120	128	M10	75	40.8
NR4 50/200B/B	50	50	440	138	-	515	100	415	45	40	79	140	140	M10	80	52.8
NR4 50/200A/B	50	50	440	138	-	515	100	415	45	40	79	140	140	M10	80	53.6
NR4 50/250C/B	50	50	440	138	-	516	100	416	45	40	79	175	175	M10	85	70.3
NR4 50/250B/B	50	50	440	159	-	545	100	445	45	40	79	175	175	M10	85	80.4
NR4 50/250A/A	50	50	440	159	-	545	100	445	45	40	79	175	175	M10	85	81.9
NR4 65/125F/A	65	65	340	128	-	454	105	349	60	50	110	121	145	M10	95	38.2
NR4 65/125D/A	65	65	340	128	-	454	105	349	60	50	110	121	145	M10	95	40.5
NR4 65/125A/B	65	65	340	128	-	494	105	389	60	50	110	121	145	M10	95	44.4
NR4 65/125S/B	65	65	340	128	-	494	105	389	60	50	110	121	145	M10	95	44.5
NR4 65/160B/B	65	65	340	138	-	522	105	417	60	50	110	121	142	M10	95	50.9
NR4 65/160A/B	65	65	340	138	-	522	105	417	60	50	110	121	142	M10	95	51
NR4 65/200C/B	65	65	475	138	-	536	105	431	60	50	110	140	153	M10	90	61.3
NR4 65/200B/B	65	65	475	138	-	536	105	431	60	50	110	140	153	M10	90	63.5
NR4 65/200A/B	65	65	475	159	-	555	105	450	60	50	110	140	153	M10	90	72.3
NR4 65/250D/B	65	65	475	159	-	554	105	449	60	50	110	175	175	M10	90	85
NR4 65/250C/B	65	65	475	159	-	554	105	449	60	50	110	175	175	M10	90	85.4
NR4 65/250B/A	65	65	475	159	-	554	105	449	60	50	110	175	175	M10	90	85
NR4 65/250A/A	65	65	475	159	-	554	105	449	60	50	110	175	175	M10	90	94.6

TYPE			mm													kg
	DN1	DN2	a	AD	b	fM	h1	h6	l1	l2	s1	x	Weight			
NR4M 50C/A	50	50	320	111	98	363.5	90	273.5	93	100	M16	70	23.6			
NR4M 50B/A	50	50	320	111	98	363.5	90	273.5	93	100	M16	70	24			
NR4M 50A/A	50	50	320	111	98	363.5	90	273.5	93	100	M16	70	24.1			
NR4M 65C/A	65	65	360	111	118	373.5	100	273.5	102	114	M16	70	27			

Flanges EN 1092-2

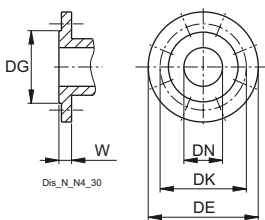

DN	PN	DG	DK	DE	Holes		W
					N°	ø	
					32	10-16	
40	10-16	84	110	150	4	19	18
50	10-16	99	125	165	4	19	20
65	10-16	118	145	185	4	19	20
80	10-16	132	160	200	8	19	22
100	10-16	156	180	220	8	19	24
125	10-16	184	210	250	8	19	24

NR(D)(EI), NR(D)4(EI)



Dimensions and weights

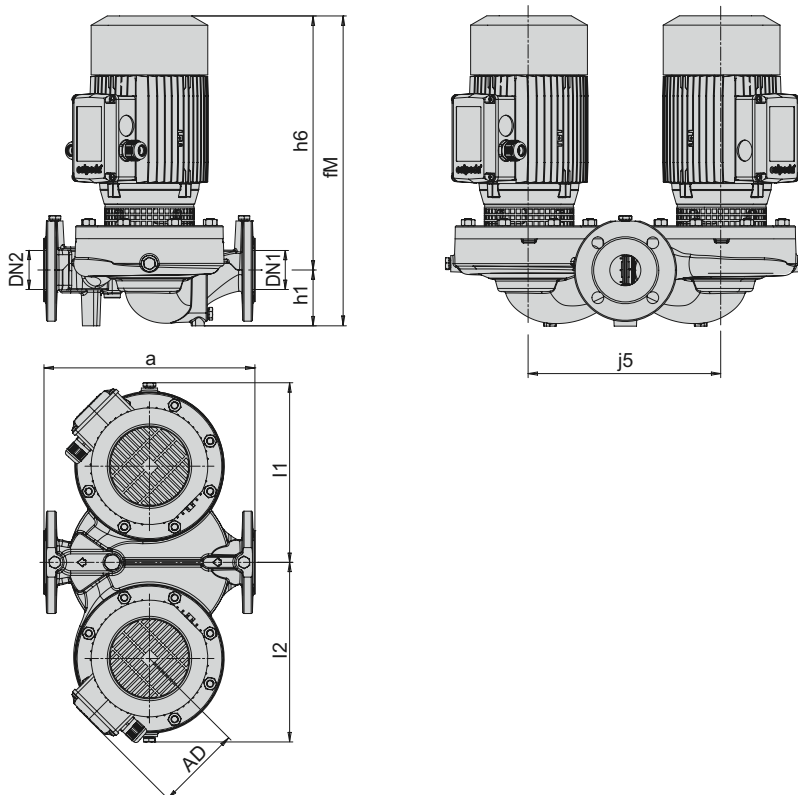

TYPE	DN1	DN2	mm								kg
			a	AD	fM	h1	h6	j5	l1	l2	Weight
NRD 50/125F	50	50	340	130	433.5	90	343.5	310	278.5	278.5	62.7
NRD 50/125C	50	50	340	130	433.5	90	343.5	310	278.5	278.5	66.2
NRD 50/125A	50	50	340	130	473.5	90	383.5	310	278.5	278.5	72
NRD 50/160C	50	50	340	130	473.5	90	383.5	310	291.5	291.5	79
NRD 50/160B	50	50	340	139	499.5	90	409.5	310	291.5	291.5	91.8
NRD 50/160A	50	50	340	139	499.5	90	409.5	310	291.5	291.5	101.5
NRD 65/125F	65	65	340	128	488.5	105	383.5	310	303.5	303.5	86.8
NRD 65/125D	65	65	340	138	514.5	105	409.5	310	303.5	303.5	99.6
NRD 65/125A	65	65	340	138	514.5	105	409.5	310	303.5	303.5	106.2
NRD 65/160B	65	65	340	160	543.5	105	438.5	310	303.5	303.5	-
NRD 65/160A	65	65	340	160	543.5	105	438.5	310	303.5	303.5	-

TYPE	DN1	DN2	mm								kg
			a	AD	fM	h1	h6	j5	l1	l2	Weight
NRD4 50/160C	50	50	340	130	433.5	90	343.5	310	291.5	291.5	65.5
NRD4 50/160B	50	50	340	130	433.5	90	343.5	310	291.5	291.5	69.2
NRD4 50/160A	50	50	340	130	473.5	90	383.5	310	291.5	291.5	79.5
NRD4 65/125F	65	65	340	130	448.5	105	343.5	310	303.5	303.5	-
NRD4 65/125D	65	65	340	130	448.5	105	343.5	310	303.5	303.5	76.3
NRD4 65/125A	65	65	340	130	488.5	105	383.5	310	303.5	303.5	87.5
NRD4 65/160B	65	65	340	138	514.5	105	409.5	310	303.5	303.5	-
NRD4 65/160A	65	65	340	138	514.5	105	409.5	310	303.5	303.5	-

Flanges EN 1092-2

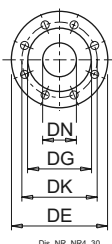

Dis_NR_NR4_30

DN	PN	DG	DK	DE	Holes		W
					N°	ø	
					32	10-16	
40	10-16	84	110	150	4	19	18
50	10-16	99	125	165	4	19	20
65	10-16	118	145	185	4	19	20
80	10-16	132	160	200	8	19	22
100	10-16	156	180	220	8	19	24
125	10-16	184	210	250	8	19	24

NR(D)(EI), NR(D)4(EI)



Dimensions and weights

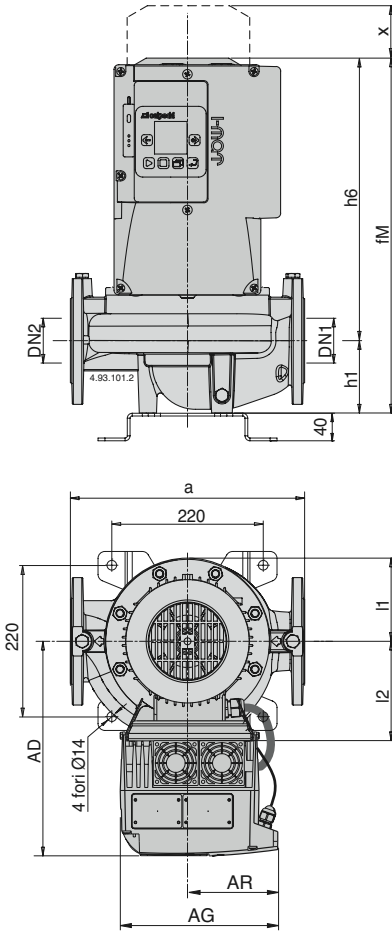

TYPE	DN		mm										kg
	DN1	DN2	a	AD	AG	AR	fM	h1	h6	l1	l2	x	Weight
NR EI 50D/A	50	50	320	266	190	105	363.5	90	273.5	93	100	70	29.3
NR EI 50C/B	50	50	320	266	190	105	363.5	90	273.5	93	100	70	32.3
NR EI 32/125B	32	32	260	266	190	105	351	80	271	86	88	60	24.8
NR EI 32/125A	32	32	260	266	190	105	351	80	271	86	88	60	-
NR EI 32/160B/A	32	32	340	282	190	105	421	80	341	102	102	60	35
NR EI 32/160A/A	32	32	340	282	190	105	421	80	341	102	102	60	-
NR EI 32/200B/A	32	32	440	282	210	117.5	469	85	384	126	126	60	-
NR EI 32/200A	32	32	440	292	210	117.5	495	85	410	126	126	60	-
NR EI 32/200S/A	32	32	440	292	210	117.5	495	85	410	126	126	60	-
NR EI 40/125C	40	40	320	282	190	105	423	81	342	93	98	70	34
NR EI 40/125B/A	40	40	320	282	190	105	423	81	342	93	98	70	36
NR EI 40/125A/A	40	40	320	282	190	105	423	81	342	93	98	70	37.4
NR EI 40/160B/A	40	40	320	282	190	105	430	81	349	119	119	75	42.4
NR EI 40/160A/A	40	40	320	282	210	117.5	470	81	389	119	119	75	47
NR EI 40/200B	40	40	440	292	210	117.5	496	81	415	140	140	75	64
NR EI 40/200A/A	40	40	440	292	210	117.5	496	81	415	140	140	75	66.7
NR EI 50/125F/A	50	50	340	282	190	105	437	90	347	96	115	75	39
NR EI 50/125C/A	50	50	340	282	190	105	437	90	347	96	115	75	40.3
NR EI 50/125A/B	50	50	340	282	210	117.5	477	90	387	96	115	75	-
NR EI 50/160C/B	50	50	340	282	210	117.5	480	90	390	120	128	75	-
NR EI 50/160B/A	50	50	340	292	210	117.5	506	90	416	120	128	75	55.2
NR EI 50/160A/B	50	50	340	292	210	117.5	506	90	416	120	128	75	58.8
NR EI 50/200D/B	50	50	440	292	210	117.5	515	100	415	140	140	80	-
NR EI 50/200B/A	50	50	440	317	210	117.5	544	100	444	140	140	80	-
NR EI 50/200A/A	50	50	440	359	281	153.5	544	100	444	140	140	80	90.6
NR EI 50/250C/B	50	50	440	382	281	153.5	656	100	556	175	175	85	-
NR EI 50/250B/A	50	50	440	382	281	153.5	656	100	556	175	175	85	-
NR EI 50/250A/B	50	50	440	463	350	190	731	100	631	175	175	85	-
NR EI 65/125F/B	65	65	340	282	210	117.5	494	105	389	121	145	95	53.9
NR EI 65/125D/A	65	65	340	292	210	117.5	519	105	414	121	145	95	60.8
NR EI 65/125A/B	65	65	340	292	210	117.5	519	105	414	121	145	95	-
NR EI 65/125B/B	65	65	340	292	210	117.5	519	105	414	121	145	95	63.8
NR EI 65/160B/A	65	65	340	317	210	117.5	552	105	447	121	142	95	76.9
NR EI 65/160A/A	65	65	340	359	281	153.5	552	105	447	121	142	95	-
NR EI 65/200B/B	65	65	475	383	281	153.5	666	105	561	140	153	90	-
NR EI 65/200A/A	65	65	475	382	281	153.5	666	105	561	140	153	90	-
NR EI 65/200S/B	65	65	475	463	350	190	741	105	636	140	153	90	-
NR EI 65/250C/A	65	65	475	389	281	153.5	670	105	565	175	175	90	-
NR EI 65/250B/B	65	65	475	463	350	190	745	105	640	175	175	90	-
NR EI 65/250A/C	65	65	475	488	350	190	791	105	686	175	175	90	-
NR EI 80/125E	80	80	440	293	210	117	534	105	429	129	152	105	-
NR EI 80/125C	80	80	440	324	210	117	595	105	490	129	152	105	-
NR EI 80/125A	80	80	440	366	282	155	595	105	490	129	152	105	-

Flanges EN 1092-2

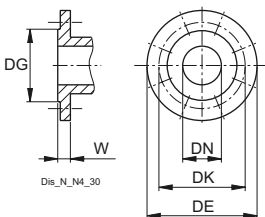

DN	PN	DG	DK	DE	Holes		W
					N°	ø	
					32	10-16	
40	10-16	84	110	150	4	19	18
50	10-16	99	125	165	4	19	20
65	10-16	118	145	185	4	19	20
80	10-16	132	160	200	8	19	22
100	10-16	156	180	220	8	19	24
125	10-16	184	210	250	8	19	24

NR(D)(EI), NR(D)4(EI)



Dimensions and weights

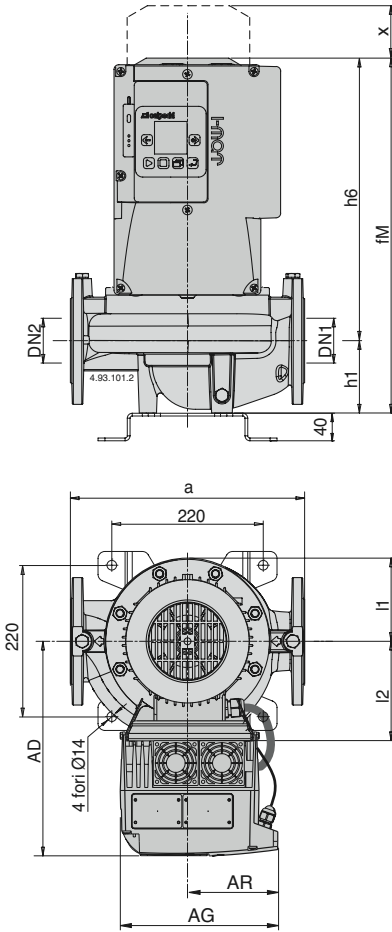

TYPE			mm										kg
	DN1	DN2	a	AD	AG	AR	fM	h1	h6	l1	l2	x	Weight
NR4 EI 50C/A	50	50	320	266	190	105	363.5	90	273.5	93	100	70	-
NR4 EI 50B/A	50	50	320	266	190	105	363.5	90	273.5	93	100	70	-
NR4 EI 50A/A	50	50	320	266	190	105	363.5	90	273.5	93	100	70	-
NR4 EI 65C/A	65	65	360	266	190	105	373.5	100	273.5	102	114	70	-
NR4 EI 65B/A	65	65	360	266	190	105	373.5	100	273.5	102	114	70	-
NR4 EI 65A/A	65	65	360	266	190	105	373.5	100	273.5	102	114	70	-
NR4 EI 100C/B	100	100	500	292	190	105	548	150	398	153	173	105	-
NR4 EI 100B/B	100	100	500	292	190	105	548	150	398	153	173	105	-
NR4 EI 100A/B	100	100	500	292	190	105	548	150	398	153	173	105	-
NR4 EI 125C/B	125	125	600	317	210	117.5	608	170	438	172	195	120	110
NR4 EI 125B/A	125	125	600	317	210	117.5	608	170	438	172	195	120	111.7
NR4 EI 125A/A	125	125	600	317	210	117.5	608	170	438	172	195	120	-
NR4 EI 32/160B/A	32	32	340	282	190	105	421	80	341	102	102	60	-
NR4 EI 32/160A/A	32	32	340	282	190	105	421	80	341	102	102	60	-
NR4 EI 32/200C/A	32	32	440	282	190	105	426	85	341	126	126	60	-
NR4 EI 32/200B/A	32	32	440	282	190	105	426	85	341	126	126	60	-
NR4 EI 32/200A/A	32	32	440	282	190	105	426	85	341	126	126	60	-
NR4 EI 40/160B/A	40	40	320	282	190	105	430	81	349	119	119	75	-
NR4 EI 40/160A/A	40	40	320	282	190	105	430	81	349	119	119	75	-
NR4 EI 40/200B/A	40	40	440	282	190	105	430	81	349	140	140	75	-
NR4 EI 40/200A/A	40	40	440	282	190	105	430	81	349	140	140	75	-
NR4 EI 50/160C/A	50	50	340	282	190	105	440	90	350	120	128	75	-
NR4 EI 50/160B/A	50	50	340	282	190	105	440	90	350	120	128	75	-
NR4 EI 50/160A/B	50	50	340	282	190	105	480	90	390	120	128	75	48.1
NR4 EI 50/200B/B	50	50	440	292	190	105	515	100	415	140	140	80	-
NR4 EI 50/200A/B	50	50	440	292	190	105	515	100	415	140	140	80	-
NR4 EI 50/250C/B	50	50	440	292	190	105	516	100	416	175	175	85	77.3
NR4 EI 50/250B/B	50	50	440	317	210	117.5	545	100	445	175	175	85	-
NR4 EI 50/250A/A	50	50	440	318	210	117.5	545	100	445	175	175	85	-
NR4 EI 65/125F/A	65	65	340	282	190	105	454	105	349	121	145	95	-
NR4 EI 65/125D/A	65	65	340	282	190	105	454	105	349	121	145	95	-
NR4 EI 65/125A/B	65	65	340	282	190	105	494	105	389	121	145	95	-
NR4 EI 65/125S/B	65	65	340	282	190	105	494	105	389	121	145	95	54
NR4 EI 65/160B/B	65	65	340	292	190	105	522	105	417	121	142	95	-
NR4 EI 65/160A/B	65	65	340	292	190	105	522	105	417	121	142	95	-
NR4 EI 65/200C/B	65	65	475	292	190	105	536	105	431	140	153	90	-
NR4 EI 65/200B/B	65	65	475	292	190	105	536	105	431	140	153	90	-
NR4 EI 65/200A/B	65	65	475	317	210	117.5	555	105	450	140	153	90	-
NR4 EI 65/250D/B	65	65	475	317	210	117.5	554	105	449	175	175	90	-
NR4 EI 65/250C/B	65	65	475	317	210	117.5	554	105	449	175	175	90	-
NR4 EI 65/250B/A	65	65	475	318	210	117.5	554	105	449	175	175	90	-
NR4 EI 65/250A/A	65	65	475	317	210	117.5	554	105	449	175	175	90	103.3

Flanges EN 1092-2

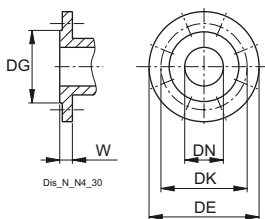

DN	PN	DG	DK	DE	Holes		W
					N°	ø	
					32	10-16	
40	10-16	84	110	150	4	19	18
50	10-16	99	125	165	4	19	20
65	10-16	118	145	185	4	19	20
80	10-16	132	160	200	8	19	22
100	10-16	156	180	220	8	19	24
125	10-16	184	210	250	8	19	24

NR(D)(EI), NR(D)4(EI)



Dimensions and weights

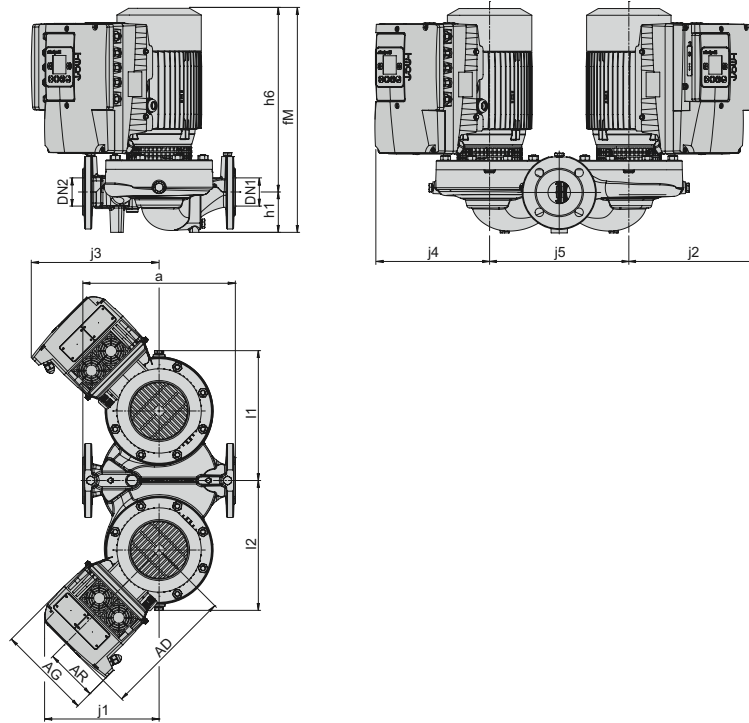

TYPE			mm														kg
	DN1	DN2	a	AD	AG	AR	fM	h1	h6	j1	j2	j3	j4	j5	l1	l2	Weight
NRD EI 50/125F	50	50	340	284	190	105	433.5	90	343.5	243	269	269	243	310	278.5	278.5	78.6
NRD EI 50/125C	50	50	340	284	190	105	433.5	90	343.5	243	269	269	243	310	278.5	278.5	79.5
NRD EI 50/125A	50	50	340	284	210	118	473.5	90	383.5	249	277	277	249	310	278.5	278.5	90.8
NRD EI 50/160C	50	50	340	284	210	118	473.5	90	383.5	249	277	277	249	310	291.5	291.5	94.7
NRD EI 50/160B	50	50	340	293	210	118	499.5	90	409.5	256	283	283	256	310	291.5	291.5	108.5
NRD EI 50/160A	50	50	340	293	210	118	499.5	90	409.5	256	283	283	256	310	291.5	291.5	117
NRD EI 65/125F	65	65	340	284	210	118	488.5	105	383.5	249	277	277	249	310	303.5	303.5	102.3
NRD EI 65/125D	65	65	340	293	210	118	514.5	105	409.5	256	283	283	256	310	303.5	303.5	118.5
NRD EI 65/125A	65	65	340	293	210	118	514.5	105	409.5	256	283	283	256	310	303.5	303.5	122.6
NRD EI 65/160B	65	65	340	364	283	156	543.5	105	438.5	274	304	304	274	310	303.5	303.5	-
NRD EI 65/160A	65	65	340	364	283	156	543.5	105	438.5	331	358	358	331	310	303.5	303.5	-

TYPE			mm													
	DN1	DN2	a	AD	AG	AR	fM	h1	h6	j1	j2	j3	j4	j5	l1	l2
NRD4 EI 50/160C	50	50	340	284	190	105	433.5	90	343.5	243	269	269	243	310	291.5	291.5
NRD4 EI 50/160B	50	50	340	284	190	105	433.5	90	343.5	243	269	269	243	310	291.5	291.5
NRD4 EI 50/160A	50	50	340	284	190	105	473.5	90	383.5	243	269	269	243	310	291.5	291.5
NRD4 EI 65/125F	65	65	340	284	190	105	448.5	105	343.5	243	269	269	243	310	303.5	303.5
NRD4 EI 65/125D	65	65	340	284	190	105	448.5	105	343.5	243	269	269	243	310	303.5	303.5
NRD4 EI 65/125A	65	65	340	284	190	105	488.5	105	383.5	243	269	269	243	310	303.5	303.5
NRD4 EI 65/160B	65	65	340	293	190	105	514.5	105	409.5	250	75	75	249	310	303.5	303.5
NRD4 EI 65/160A	65	65	340	293	190	105	514.5	105	409.5	250	75	75	249	310	303.5	303.5

Flanges EN 1092-2

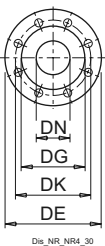

DN	PN	DG	DK	DE	Holes		W
					N°	ø	
					mm		
32	10-16	76	100	140	4	19	18
40	10-16	84	110	150	4	19	18
50	10-16	99	125	165	4	19	20
65	10-16	118	145	185	4	19	20
80	10-16	132	160	200	8	19	22
100	10-16	156	180	220	8	19	24
125	10-16	184	210	250	8	19	24

Installation

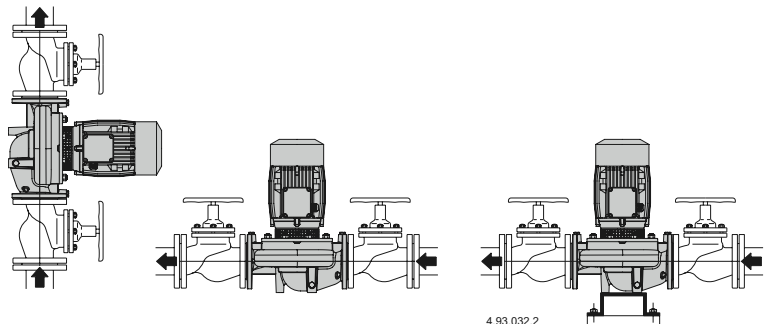

4.93.032.2