

GES-2M/4M

GES-C

KAWAMOTO STAINLESS STEEL PUMP

2, 4 POLES / 50 Hz

SUCTION SIZE 40 ~ 100 MM

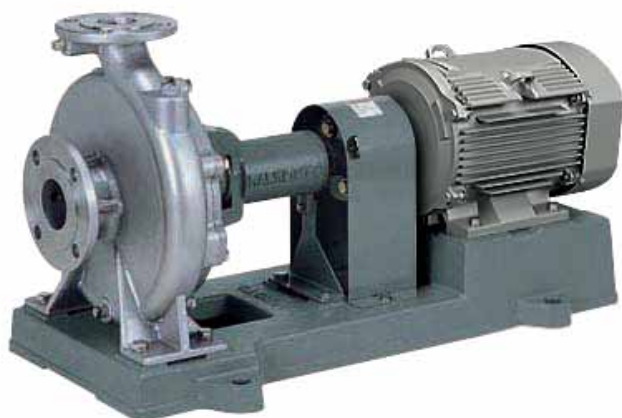

GES-2M

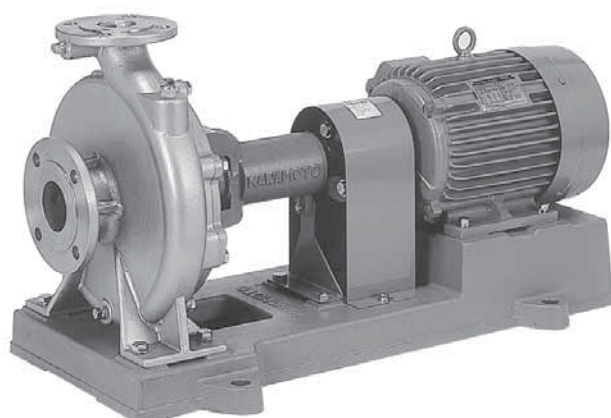

GES-4M

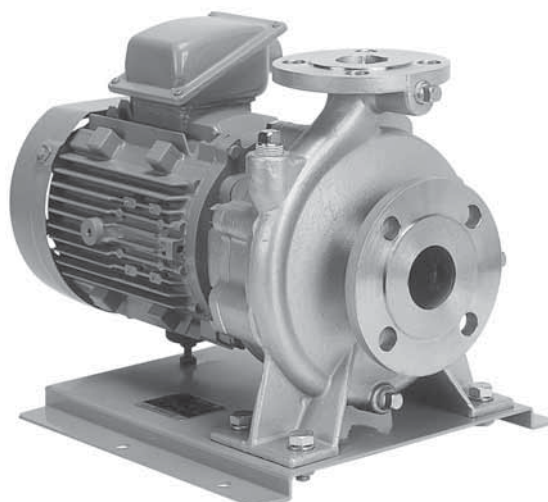

GES-C

APPLICATIONS AND FEATURES

■ APPLICATIONS

- Cooling water
- Cold and hot water circulation
- Food, beverage, liquor industry
- Water supply to building and factories
- Small regional drinking water
- Industry
- General water supply
- Factory production equipment

■ FEATURES

- Sanitary and clean due to stainless material are used for portion contacting liquid.
- Maintenance is easy because long life mechanical seal is standardly adopted for shaft seal with few water leakages.
- Easy maintenance and inspection due to back pull out construction.
- Long life and strong against dust and humidity because TEFC outdoor motor is standardly adopted.
- High efficiency and high total head pump design by using precision cast stainless steel material.

STANDARD SPECIFICATIONS

Description		Model : GES-2M/4M
Liquid	Name	Clean water
	Temperature	0 ~ 90 °C
Max Working Pressure		10 bar
Synchronous Speed		3000/1500 min ⁻¹
Installation		TEFC outdoor use (Motor IP55, Class F)
Material	Casing	Stainless cast iron (SCS13)
	Impeller	Stainless cast iron (SCS14)
	Shaft	Stainless steel (SUS316)
Construction	Impeller	Closed
	Shaft Seal	Mechanical seal (SIC x Carbon x FKM)
	Sealing	None
	Bearing	Sealed ball bearing
Flange		JIS 10K
Baseplate		Cast iron (FC150)

OPTIONAL SPECIFICATIONS

Description		Model : GES-2M/4M
Liquid	Name	Non freeze liquid
	Temperature	-15 ~ 40 °C or -5 ~ 40 °C
Material	Casing	Stainless cast iron (SCS14)
	Impeller	Stainless cast iron (SCS14)
	Shaft	Stainless steel (SUS316)
Construction	Impeller	Closed
	Shaft Seal	Mechanical seal (SIC x SIC x H-NBR)
	Sealing	Quenching
	Bearing	Sealed ball bearing
Flange		JIS 10K
Baseplate		Channel baseplate for European motor bland
Anti-Corrosion Painting		Urethane resin coating + Non touch seal bearing structure
		Epoxy resin coating

STANDARD SPECIFICATIONS

Description		Model : GES-C
Liquid	Name	Clean water
	Temperature	0 ~ 90 °C
Max Working Pressure		10 bar
Synchronous Speed		3000 min ⁻¹
Installation		TEFC outdoor use (Motor IP44, Class F)
Material	Casing	Stainless cast iron (SC513)
	Impeller	Stainless cast iron (SC513)
	Shaft	Stainless steel (SUS304)
Construction	Impeller	Closed
	Shaft Seal	Mechanical seal (SIC x Carbon x FKM)
	Sealing	None
	Bearing	Sealed ball bearing
Flange		JIS 10K
Baseplate		SPHC or Cast iron (FC150)

PERFORMANCE CHART

GES-2M

50Hz

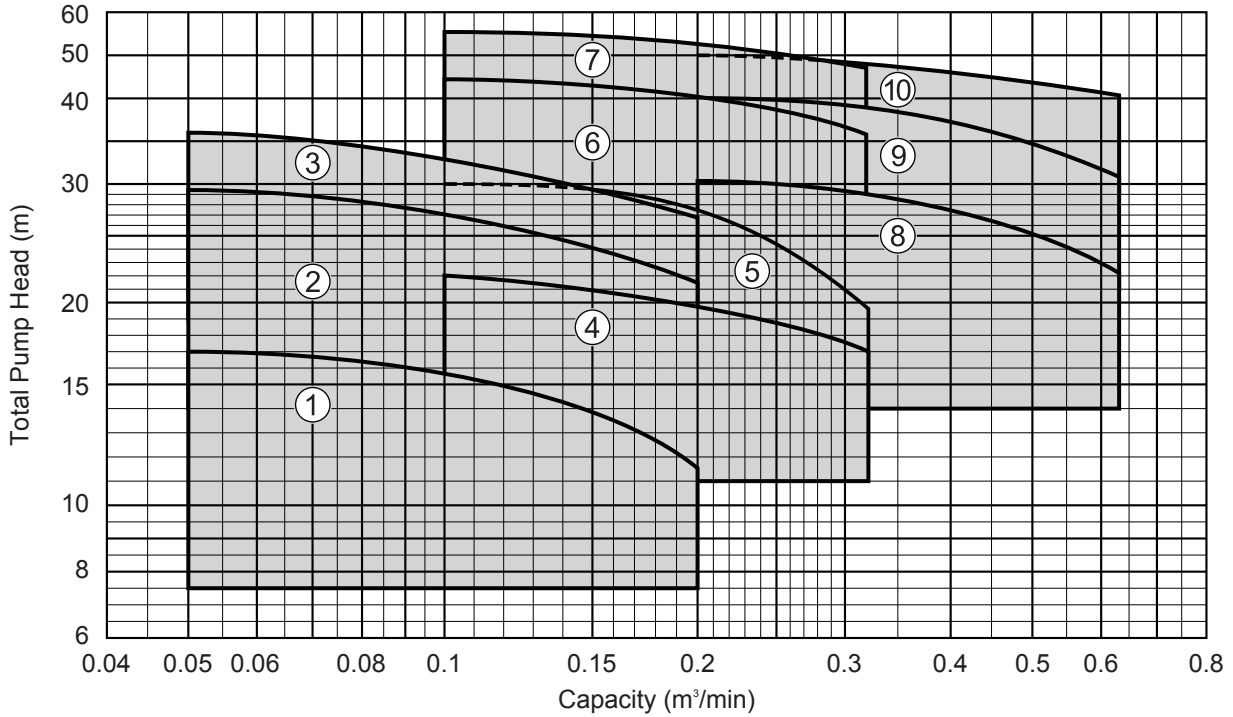

GES-4M

50Hz

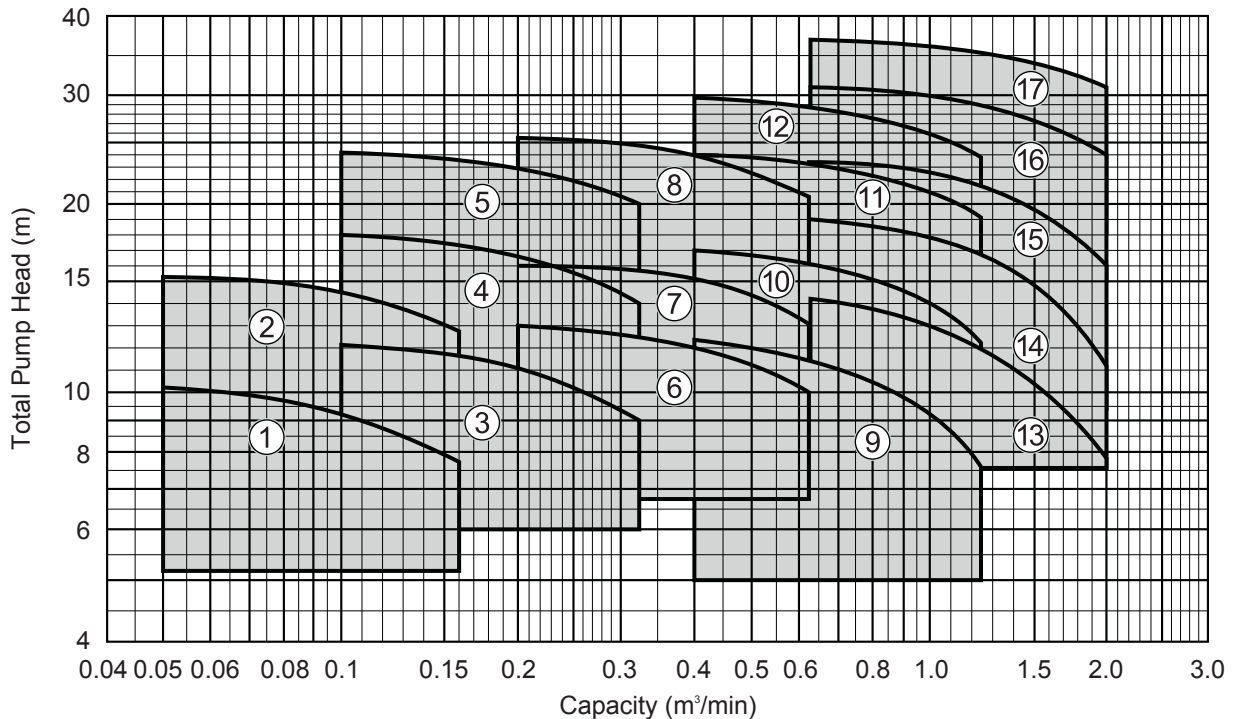

GES-C

50Hz

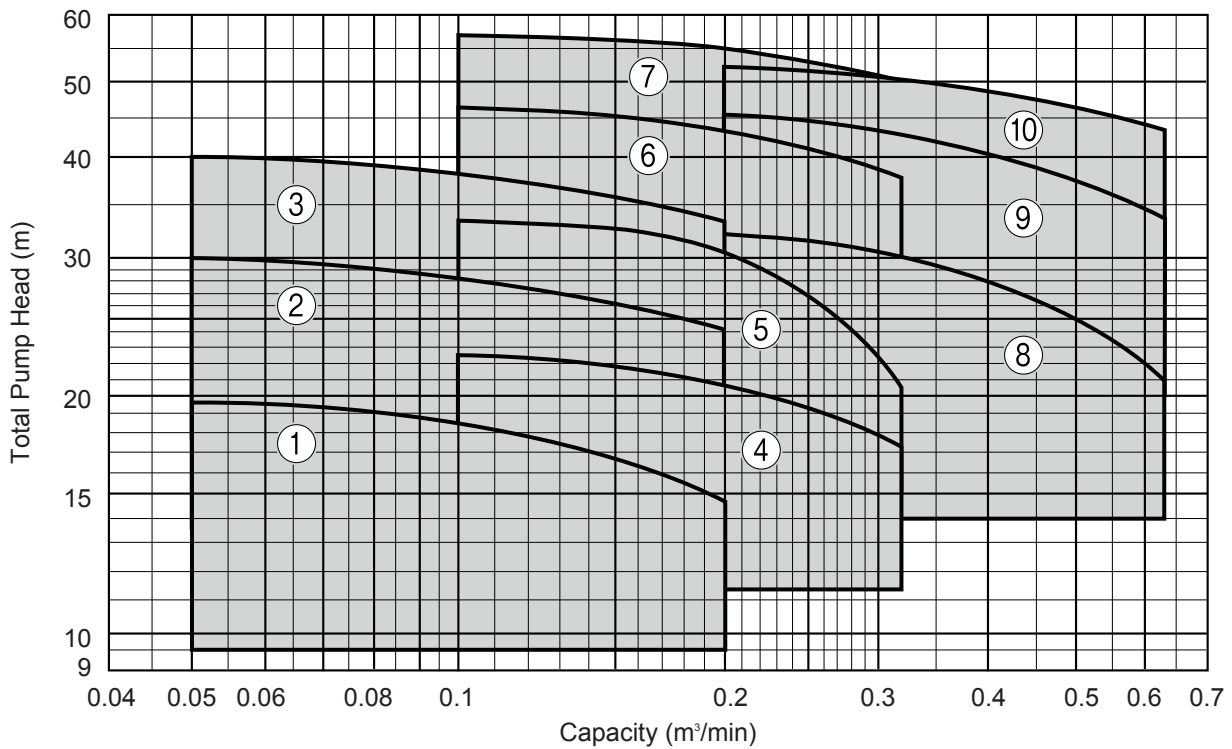

MODEL CODE

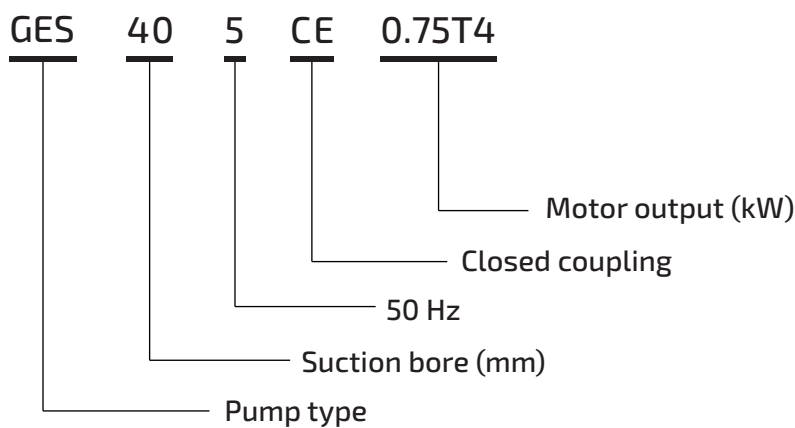
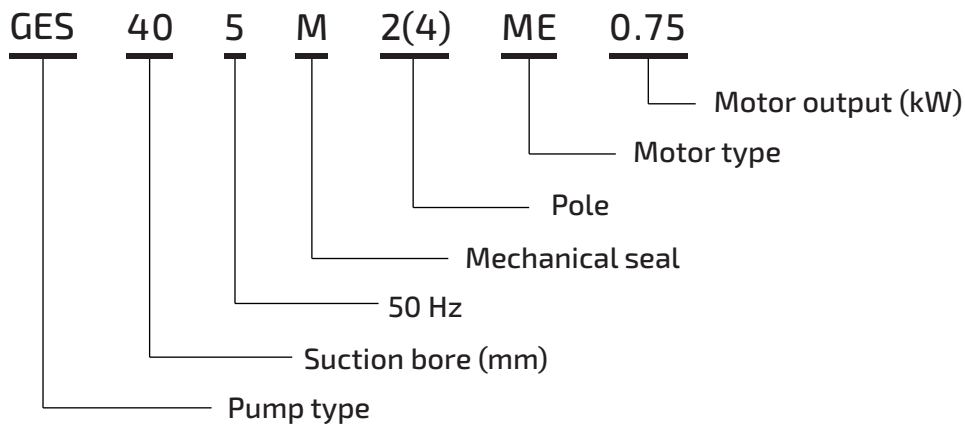

SPECIFICATION TABLE

GES-2M

No.	Model	Motor (kW)	Performance				Maximum Back Pressure (Mpa)
			Capacity (m ³ /min)	Total Head (m)	Capacity (m ³ /min)	Total Head (m)	
1	GES405M2ME0.75	0.75	0.05	17	0.2	11.5	0.80
2	GES405M2ME1.5	1.5	0.05	29.5	0.2	21.5	0.68
3	GES405M2ME2.2	2.2	0.05	35.5	0.2	27	0.62
4	GES505M2ME1.5	1.5	0.1	22	0.32	17	0.75
5	GES505M2ME2.2	2.2	0.1	30	0.32	19.5	0.67
6	GES505M2ME3.7	3.7	0.1	44	0.32	36	0.54
7	GES505M2ME5.5	5.5	0.1	55	0.32	47.5	0.42
8	GES655M2ME3.7	3.7	0.2	30.5	0.63	22	0.68
9	GES655M2ME5.5	5.5	0.2	40.5	0.63	31	0.58
10	GES655M2ME7.5	7.5	0.2	50	0.63	41.5	0.48

GES-4M

No.	Model	Motor (kW)	Performance				Maximum Back Pressure (Mpa)
			Capacity (m ³ /min)	Total Head (m)	Capacity (m ³ /min)	Total Head (m)	
1	GES405M4M0.4	0.4	0.05	10.2	0.16	7.8	0.88
2	GES405M4ME0.75	0.75	0.05	15.2	0.16	12.8	0.83
3	GES505M4ME0.75	0.75	0.1	12.2	0.32	9	0.85
4	GES505M4ME1.5	1.5	0.1	18	0.32	14	0.80
5	GES505M4ME2.2	2.2	0.1	24.2	0.32	20	0.74
6	GES655M4ME1.5	1.5	0.2	13	0.63	10	0.85
7	GES655M4ME2.2	2.2	0.2	16	0.63	13.2	0.82
8	GES655M4ME3.7	3.7	0.2	25.5	0.63	20.8	0.72
9	GES805M4ME2.2	2.2	0.4	12.5	1.25	7.5	0.85
10	GES805M4ME3.7	3.7	0.4	17	1.25	12.2	0.80
11	GES805M4ME5.5	5.5	0.4	24	1.25	19.2	0.74
12	GES805M4ME7.5	7.5	0.4	29.5	1.25	23.5	0.68
13	GES1005M4ME3.7	3.7	0.63	14.2	2.0	7.8	0.83
14	GES1005M4ME5.5	5.5	0.63	19	2.0	11.2	0.79
15	GES1005M4ME7.5	7.5	0.63	23.5	2.0	16	0.74
16	GES1005M4ME11	11	0.63	31	2.0	24	0.68
17	GES1005M4ME15	15	0.63	37	2.0	31	0.61

SPECIFICATION TABLE

GES-C

No.	Model	Motor (kW)	Performance				Maximum Back Pressure (Mpa)
			Capacity (m ³ /min)	Total Head (m)	Capacity (m ³ /min)	Total Head (m)	
1	GES405CE0.75	0.75	0.05	19.5	0.2	14.5	0.77
2	GES405CE1.5	1.5	0.05	30	0.2	24	0.68
3	GES405CE2.2	2.2	0.05	40	0.2	33	0.57
4	GES505CE1.5	1.5	0.1	22.5	0.32	17	0.74
5	GES505CE2.2	2.2	0.1	33.5	0.32	20.5	0.64
6	GES505CE3.7	3.7	0.1	45.5	0.32	37.5	0.51
7	GES505CE5.5	5.5	0.1	57	0.32	50	0.39
8	GES655CE3.7	3.7	0.2	32.5	0.63	21	0.66
9	GES655CE5.5	5.5	0.2	45	0.63	34	0.53
10	GES655CE7.5	7.5	0.2	52	0.63	43	0.46

PUMP DATA

GES-2M

No.	Model	Impeller	Mechanical Seal	Bearing		Coupling	Key	Maximum Back Pressure (Mpa)
				Motor	Pump			
1	GES405M2ME0.75	SCS14	Ø16 EA560H-N	6204ZZ	6204ZZ	Ø63 x Ø19 x Ø19	6x6x20	0.8
2	GES405M2ME1.5	SCS14	Ø20 EA560H-N	6204ZZ	6204ZZ	Ø74 x Ø19 x Ø24	6x6x32	0.68
3	GES405M2ME2.2	SCS14		6204ZZ	6204ZZ	Ø74 x Ø19 x Ø24	6x6x32	0.62
4	GES505M2ME1.5	SCS14		6304ZZ	6304ZZ	Ø100 x Ø19 x Ø24	6x6x32	0.75
5	GES505M2ME2.2	SCS14		6304ZZ	6304ZZ	Ø100 x Ø19 x Ø24	6x6x32	0.67
6	GES505M2ME3.7	SCS14		6304ZZ	6304ZZ	Ø112 x Ø19 x Ø28	6x6x32	0.54
7	GES505M2ME5.5	SCS14		Ø25 EA560H-N	6305ZZ	6305ZZ	Ø125 x Ø24 x Ø38	6x6x32
8	GES655M2ME3.7	SCS14	Ø20 EA560H-N	6304ZZ	6304ZZ	Ø112 x Ø19 x Ø28	6x6x32	0.68
9	GES655M2ME5.5	SCS14	Ø30 EA560H-N	6306ZZ	6306ZZ	Ø125 x Ø24 x Ø38	8x7x40	0.58
10	GES655M2ME7.5	SCS14		6306ZZ	6306ZZ	Ø125 x Ø24 x Ø38	8x7x40	0.48

GES-4M

No.	Model	Impeller	Mechanical Seal	Bearing		Coupling	Key	Maximum Back Pressure (Mpa)
				Motor	Pump			
1	GES-405M-4M0.4	SCS14	Ø25 EA560H-N	6305ZZ	6305ZZ	Ø74 x Ø24 x Ø14	8x7x40	0.88
2	GES405M4ME0.75	SCS14		6305ZZ	6305ZZ	Ø74 x Ø24 x Ø19	8x7x40	0.83
3	GES505M4ME0.75	SCS14		6305ZZ	6305ZZ	Ø74 x Ø24 x Ø19	8x7x40	0.85
4	GES505M4ME1.5	SCS14		6305ZZ	6305ZZ	Ø74 x Ø24 x Ø24	8x7x40	0.8
5	GES505M4ME2.2	SCS14		6305ZZ	6305ZZ	Ø112 x Ø24 x Ø28	8x7x40	0.74
6	GES655M4ME1.5	SCS14		6305ZZ	6305ZZ	Ø74 x Ø24 x Ø24	8x7x40	0.85
7	GES655M4ME2.2	SCS14		6305ZZ	6305ZZ	Ø112 x Ø24 x Ø28	8x7x40	0.82
8	GES655M4ME3.7	SCS14		6305ZZ	6305ZZ	Ø125 x Ø24 x Ø28	8x7x40	0.72
9	GES805M4ME2.2	SCS14		6305ZZ	6305ZZ	Ø112 x Ø24 x Ø28	8x7x40	0.85
10	GES805M4ME3.7	SCS14		6305ZZ	6305ZZ	Ø125 x Ø24 x Ø28	8x7x40	0.8
11	GES805M4ME5.5	SCS14	Ø30 EA560H-N	6307ZZ	6307ZZ	Ø140 x Ø32 x Ø38	10x8x50	0.74
12	GES805M4ME7.5	SCS14		6307ZZ	6307ZZ	Ø140 x Ø32 x Ø38	10x8x50	0.68
13	GES1005M4ME3.7	SCS14		6307ZZ	6307ZZ	Ø125 x Ø32 x Ø28	10x8x50	0.83
14	GES1005M4ME5.5	SCS14	35 EA560H-N	6307ZZ	6307ZZ	Ø140 x Ø32 x Ø38	10x8x50	0.79
15	GES1005M4ME7.5	SCS14		6307ZZ	6307ZZ	Ø140 x Ø32 x Ø38	10x8x50	0.74
16	GES1005M4ME11	SCS14		6307ZZ	6307ZZ	Ø160 x Ø32 x Ø42	10x8x50	0.68
17	GES1005M4ME15	SCS14		6307ZZ	6307ZZ	Ø160 x Ø32 x Ø42	10x8x50	0.61

PUMP DATA

GES-2M

No.	Model	Motor		Impeller Diameter (mm)	Coupling CLA	Shaft Diameter	
		Power (kW)	Frame (No)			Pump (mm)	Motor (mm)
1	GES405M2ME0.75	0.75	80L	G-122	AF-53	19	19
2	GES405M2ME1.5	1.5	90L	G-156	AF-64	19	24
3	GES405M2ME2.2	2.2	90L	G-173	AF-64	19	24
4	GES505M2ME1.5	1.5	90L	G-138	100	19	24
5	GES505M2ME2.2	2.2	90L	G-159	100	19	24
6	GES505M2ME3.7	3.7	112M	G-187	112	19	28
7	GES505M2ME5.5	5.5	132S	G-208	125	24	38
8	GES655M2ME3.7	3.7	112M	G-157	112	19	28
9	GES655M2ME5.5	5.5	132S	G-182	125	24	38
10	GES655M2ME7.5	7.5	132S	G-199	125	24	38

GES-4M

No.	Model	Motor		Impeller Diameter (mm)	Coupling CLA	Shaft Diameter	
		Power (kW)	Frame (No)			Pump (mm)	Motor (mm)
1	GES-405M-4M0.4	0.4	71M	G-182	AF-64	24	14
2	GES405M4ME0.75	0.75	80M	G-215	AF-64	24	19
3	GES505M4ME0.75	0.75	80M	G-193	AF-64	24	19
4	GES505M4ME1.5	1.5	90L	G-240	AF-64	24	24
5	GES505M4ME2.2	2.2	100L	G-269	112	24	28
6	GES655M4ME1.5	1.5	90L	G-198	AF-64	24	24
7	GES655M4ME2.2	2.2	100L	G-216	112	24	28
8	GES655M4ME3.7	3.7	112M	G-275	125	24	28
9	GES805M4ME2.2	2.2	100L	G-193	112	24	28
10	GES805M4ME3.7	3.7	112M	G-224	125	24	28
11	GES805M4ME5.5	5.5	132S	G-264	140	32	38
12	GES805M4ME7.5	7.5	132M	G-298	140	32	38
13	GES1005M4ME3.7	3.7	112M	G-210	125	32	28
14	GES1005M4ME5.5	5.5	132S	G-240	140	32	38
15	GES1005M4ME7.5	7.5	132M	G-266	140	32	38
16	GES1005M4ME11	11	160M	G-308	160	32	42
17	GES1005M4ME15	15	160L	G-334	160	32	42

SECTION VIEW - MECHANICAL SEAL (GES-2M/4M)

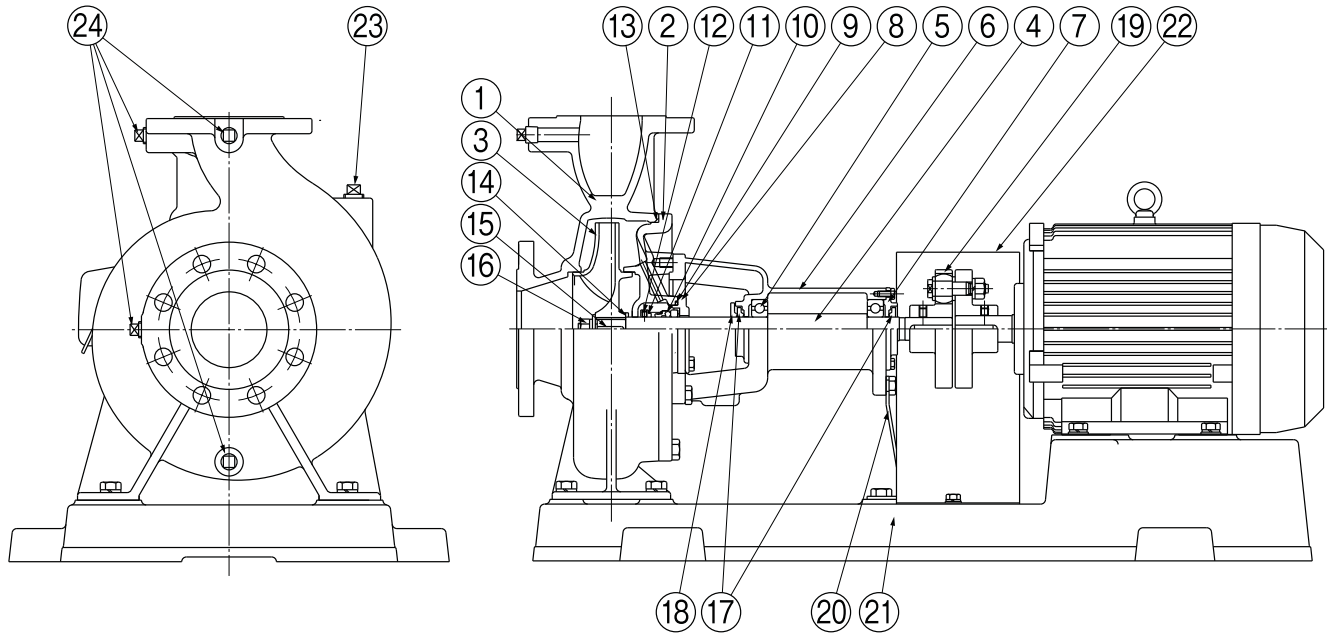

No.	Part Name	Material	No.	Part Name	Material
1	Casing	SCS13	13	O-Ring	Rubber
2	Casing cover	SCS13	14	Ajust ring	SUS316
3	Impeller	SCS14	15	Key	SUS316
4	Shaft	SUS316+S35C	16	Nut	SUS304 (GES-2M) SUS316 (GES-4M)
5	Bearing	-	17	Deflector	Rubber
6	Bearing box	FC	18	Deflector	Rubber
7	Bearing cover	FC	19	Coupling	FC
8	Mechanical seal cover	SCS14	20	Supporter	SPHC
9	O-Ring	Rubber	21	Baseplate	FC
10	Mechanical seal	-	22	Coupling guard	SPCC
11	Stopper ring	SUS316	23	Plug	SCS13
12	Screw	SUS304 (GES-2M) SUS316 (GES-4M)	24	Plug	SCS13

SECTION VIEW - MECHANICAL SEAL (GES-C)

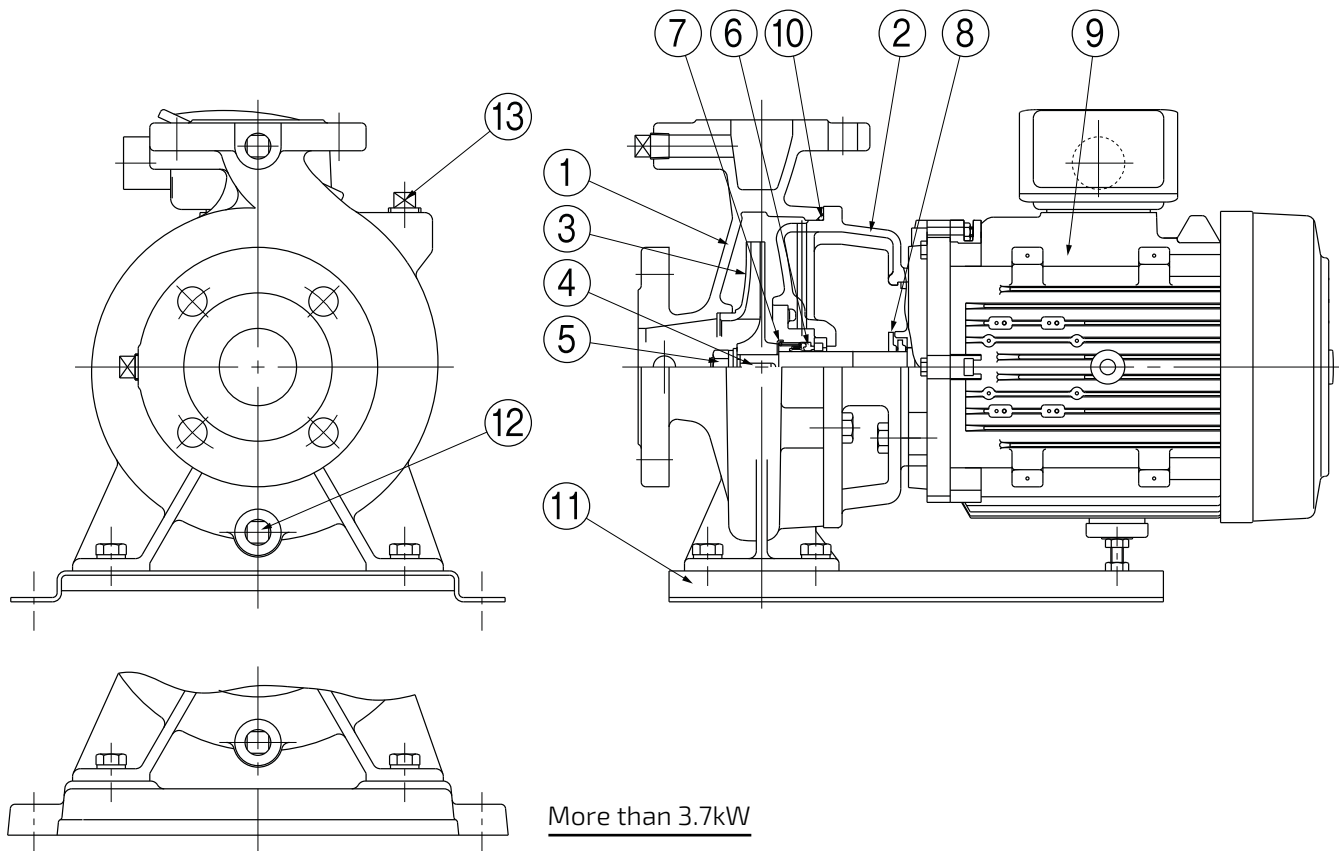

No.	Part Name	Material	No.	Part Name	Material
1	Casing	SCS13	8	Deflector	Rubber
2	Casing cover	SCS13	9	Motor	-
3	Impeller	SCS14	10	O-Ring	Rubber
4	Key	SUS304	11	Baseplate	SPHC or FC
5	Nut	SUS304	12	Plug	SCS13
6	Mechanical seal	-	13	Plug	SCS13
7	Spring	SUS304			

DRAWING DIMENSION – BARE PUMP (GES-2M)

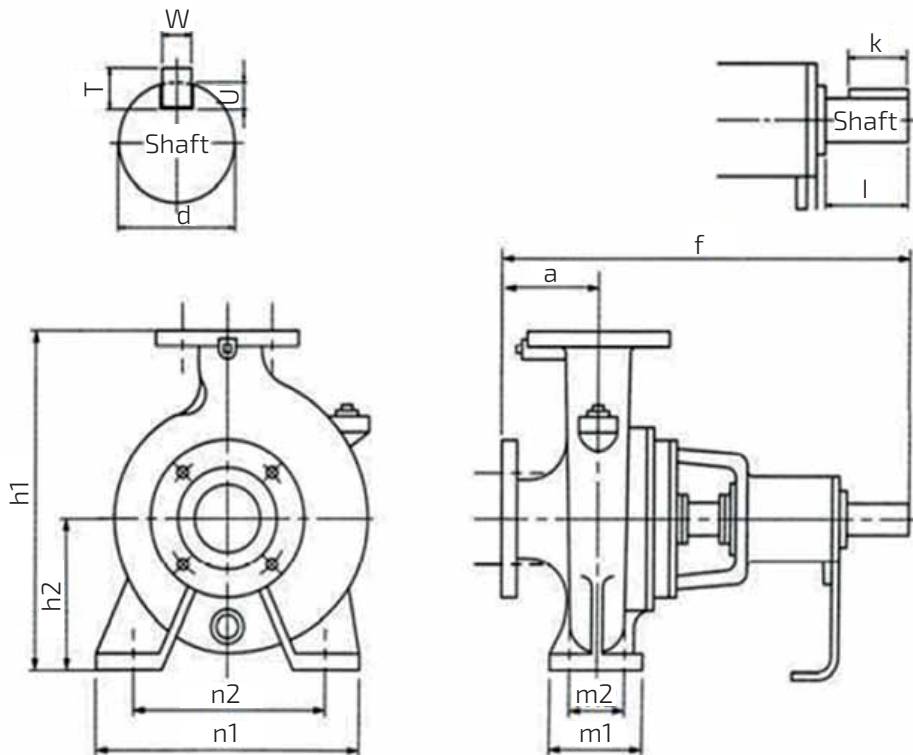

Bore d1xd2 (mm)	Model	Motor (kW)	Pump Dimension								Shaft		Coupling Key				Weight (kg)
			h1	h2	n1	n2	a	f	m1	m2	d	l	T	W	U	k	
40x32	GES405M2ME0.75	0.75	252	112	180	140	65	265	80	56	19	28	6	6	3.5	20	18
	GES405M2ME1.5	1.5	292	132	240	190	80	360	100	70	19	40	6	6	3.5	32	26.7
	GES405M2ME2.2	2.2	292	132	240	190	80	360	100	70	19	40	6	6	3.5	32	27.7
50x40	GES505M2ME1.5	1.5	252	112	190	140	80	440	100	70	19	40	6	6	3.5	32	32.7
	GES505M2ME2.2	2.2	292	132	240	190	80	440	100	70	19	40	6	6	3.5	32	28
	GES505M2ME3.7	3.7	292	132	240	190	80	440	100	70	19	40	6	6	3.5	32	36.2
	GES505M2ME5.5	5.5	340	160	240	190	80	440	100	70	24	50	6	6	4	32	50.6
65x50	GES655M2ME3.7	3.7	292	132	240	190	80	440	100	70	19	40	6	6	3.5	32	37.2
	GES655M2ME5.5	5.5	340	160	265	212	100	460	100	70	24	50	6	6	4	32	55.6
	GES655M2ME7.5	7.5	340	160	265	212	100	460	100	70	24	50	7	8	4	40	51.6

DRAWING DIMENSION – BARE PUMP (GES-4M)

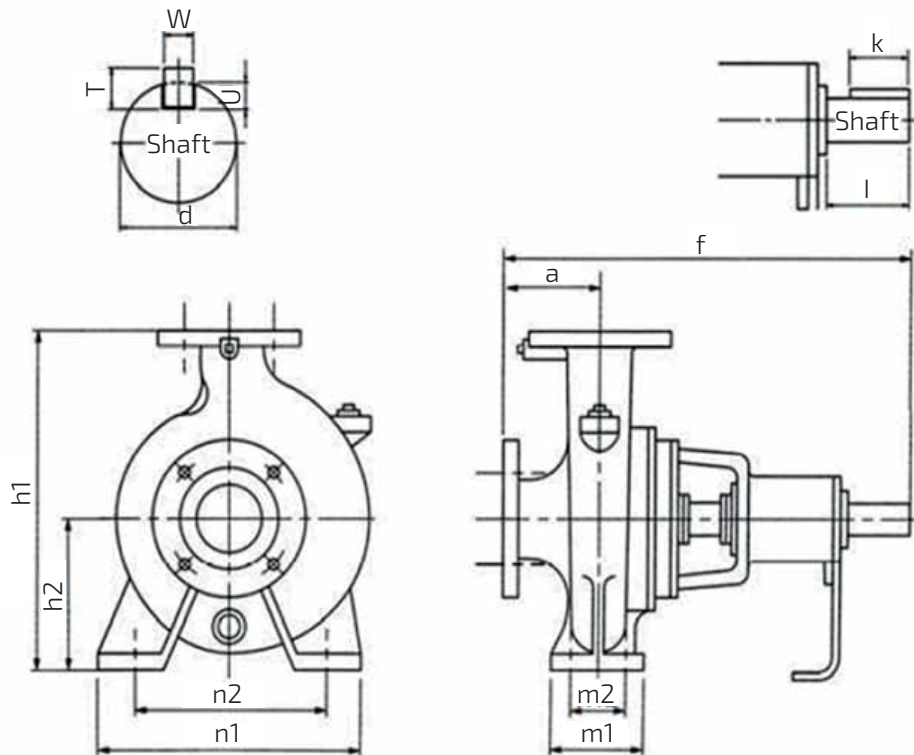

Bore d1xd2 (mm)	Model	Motor (kW)	Pump Dimension								Shaft		Coupling Key				Weight (kg)
			h1	h2	n1	n2	a	f	m1	m2	d	l	T	W	U	k	
40x32	GES-405M-4M0.4	0.4	340	160	240	190	80	460	100	70	24	50	7	8	4	40	31.6
	GES405M4ME0.75	0.75	340	160	240	190	80	460	100	70	24	50	7	8	4	40	38.1
50x40	GES505M4ME0.75	0.75	340	160	265	212	100	460	100	70	24	50	7	8	4	40	40.1
	GES505M4ME1.5	1.5	405	180	320	250	100	460	125	95	24	50	7	8	4	40	46
	GES505M4ME2.2	2.2	405	180	320	250	100	460	125	95	24	50	7	8	4	40	43
65x50	GES655M4ME1.5	1.5	360	160	265	212	100	460	100	70	24	50	7	8	4	40	37
	GES655M4ME2.2	2.2	360	160	265	212	100	460	100	70	24	50	7	8	4	40	42
	GES655M4ME3.7	3.7	405	180	320	250	100	460	125	95	24	50	7	8	4	40	49
80x65	GES805M4ME2.2	2.2	405	180	320	250	100	460	125	95	24	50	7	8	4	40	45.4
	GES805M4ME3.7	3.7	405	180	320	250	100	460	125	95	24	50	7	8	4	40	42
	GES805M4ME5.5	5.5	450	200	360	280	100	570	160	120	32	24.5	8	10	5	50	62
	GES805M4ME7.5	7.5	505	225	400	315	125	595	160	120	32	80	8	10	5	55.5	83.8
100x80	GES1005M4ME3.7	3.7	430	180	345	280	125	595	125	95	32	24.5	8	10	5	50	69
	GES1005M4ME5.5	5.5	505	225	400	315	125	595	160	120	32	80	8	10	5	50	51
	GES1005M4ME7.5	7.5	505	225	400	315	125	595	160	120	32	80	8	10	5	50	81
	GES1005M4ME11	11	565	250	400	315	125	595	160	120	32	80	8	10	5	50	96
	GES1005M4ME15	15	565	250	400	315	125	595	160	120	32	80	8	10	5	50	102

DRAWING DIMENSION - COMPLETE SET (GES-2M)

● Flange

Unit : mm

Suction Bore	Discharge Bore	g1	g2	n1	n2
d1	d2				
40	32	105	100	4	4
50	40	120	105	4	4
65	50	140	120	4	4

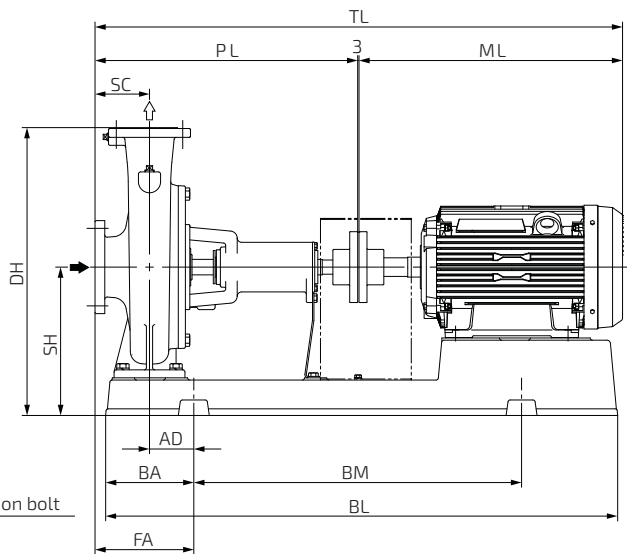
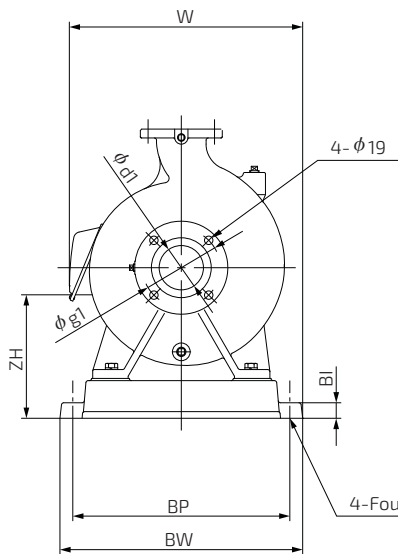
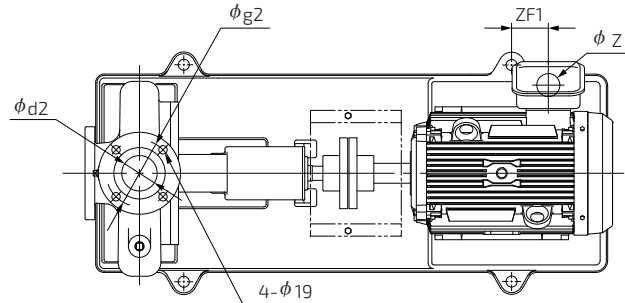

Unit : mm

Suction d1 x Discharge d2 (mm)	Model	Motor (kW)	Pump		Baseplate					
			SC	PL	BI	BL	BA	BM	BP	BW
40x32	GES405M2ME0.75	0.75	65	265	20	468	82	300	230	266
	GES405M2ME1.5	1.5	80	360	25	648	112	420	290	336
	GES405M2ME2.2	2.2	80	360	25	648	112	420	290	336
50x40	GES505M2ME1.5	1.5	80	440	25	726	127	480	290	336
	GES505M2ME2.2	2.2	80	440	25	722	120	480	290	336
	GES505M2ME3.7	3.7	80	440	25	818	138	540	320	366
	GES505M2ME5.5	5.5	80	440	25	819	138	540	350	396
65x50	GES655M2ME3.7	3.7	80	440	25	818	138	540	320	366
	GES655M2ME5.5	5.5	100	460	25	819	138	540	350	396
	GES655M2ME7.5	7.5	100	460	25	819	138	540	350	396

Continue to the next page

DRAWING DIMENSION - COMPLETE SET (GES-2M)

● Flange

Unit : mm

Suction Bore	Discharge Bore	g1	g2	n1	n2
d1	d2				
40	32	105	100	4	4
50	40	120	105	4	4
65	50	140	120	4	4

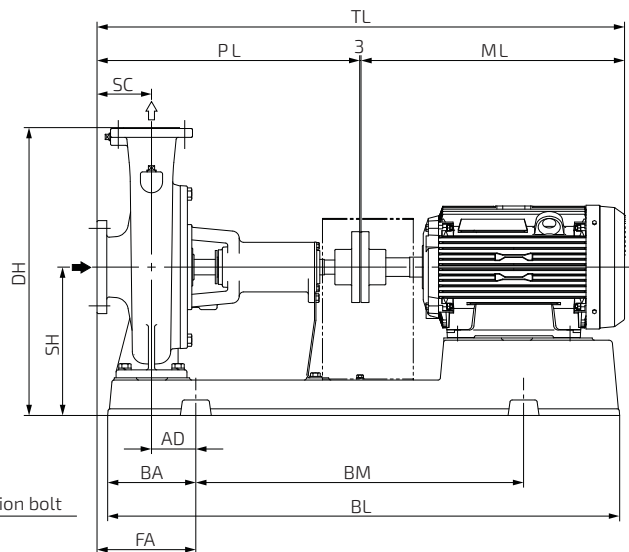
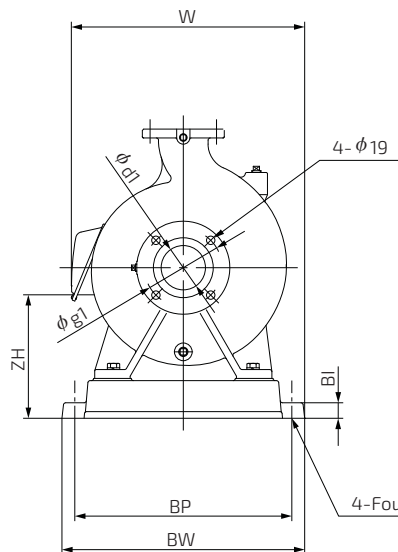
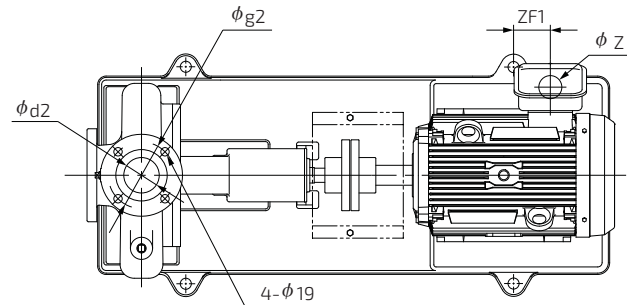

Unit : mm

Suction d1 x Discharge d2 (mm)	Model	Motor (kW)	Combination							Other				Weight (kg)
			DH	SH	TL	AD	FA	W	ML	ZF1	ZF2	ZH	Z	
40x32	GES405M2ME0.75	0.75	317	177	530	35	100	278	262	48	-3	160	27	39
	GES405M2ME1.5	1.5	347	187	675	50	130	-	312	35	13	171	27	54
	GES405M2ME2.2	2.2	347	187	675	50	130	-	312	35	13	171	27	57
50x40	GES505M2ME1.5	1.5	307	167	755	60	140	-	312	45	13	154	27	60
	GES505M2ME2.2	2.2	347	187	755	55	135	-	312	50	13	174	27	64
	GES505M2ME3.7	3.7	357	197	830	70	150	-	381	24	8	190	27	90
	GES505M2ME5.5	5.5	405	225	894	70	150	-	451	67	2	215	27	119
65x50	GES655M2ME3.7	3.7	357	197	830	70	150	-	381	22	8	190	27	91
	GES655M2ME5.5	5.5	405	225	914	70	170	-	451	67	2	215	27	124
	GES655M2ME7.5	7.5	405	225	914	70	170	-	451	67	2	215	27	126

DRAWING DIMENSION - COMPLETE SET (GES-4M)

● Flange

Unit : mm

Suction Bore	Discharge Bore	g1	g2	n1	n2
d1	d2				
40	32	105	100	4	4
50	40	120	105	4	4
65	50	140	120	4	4
80	65	150	140	8	4
100	80	175	150	8	8

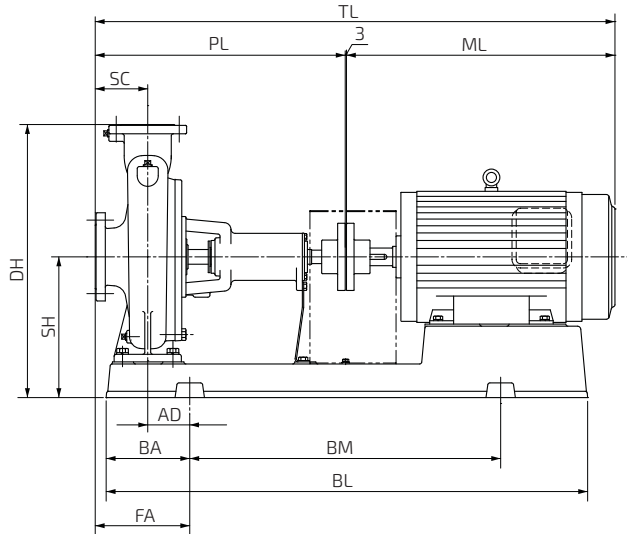
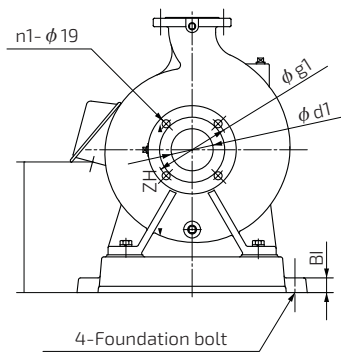
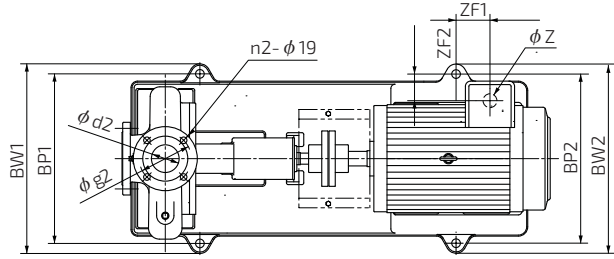

Unit : mm

Suction d1 x Discharge d2 (mm)	Model	Motor (kW)	Pump		Baseplate							
			SC	PL	BI	BL	BA	BM	BP1	BP2	BW1	BW2
40x32	GES-405M-4M0.4	0.4	80	460	25	654	112	420	290	230	336	276
	GES405M4ME0.75	0.75	80	460	25	733	122	480	290	290	336	336
50x40	GES505M4ME0.75	0.75	100	460	25	733	122	480	320	320	366	366
	GES505M4ME1.5	1.5	100	460	35	825	138	540	400	290	458	348
	GES505M4ME2.2	2.2	100	460	35	825	138	540	400	290	458	348
65x50	GES655M4ME1.5	1.5	100	460	25	731	122	480	320	320	366	366
	GES655M4ME2.2	2.2	100	460	25	731	122	480	320	320	366	366
	GES655M4ME3.7	3.7	100	460	35	823	138	540	400	320	458	378
80x65	GES805M4ME2.2	2.2	100	460	35	825	138	540	400	290	458	348
	GES805M4ME3.7	3.7	100	460	35	823	138	540	400	320	458	378
	GES805M4ME5.5	5.5	100	570	35	923	158	600	440	350	498	408
	GES805M4ME7.5	7.5	125	595	35	1029	180	660	490	350	548	408
100x80	GES1005M4ME3.7	3.7	125	595	35	921	158	600	440	350	498	408
	GES1005M4ME5.5	5.5	125	595	35	1029	180	660	490	350	548	408
	GES1005M4ME7.5	7.5	125	595	35	1029	180	660	490	350	548	408
	GES1005M4ME11	11	125	595	35	1146	199	740	490	400	548	458
	GES1005M4ME15	15	125	595	35	1146	199	740	490	400	548	458

Continue to the next page

DRAWING DIMENSION - COMPLETE SET (GES-4M)

● Flange

Unit : mm

Suction Bore d1	Discharge Bore d2	g1	g2	n1	n2
40	32	105	100	4	4
50	40	120	105	4	4
65	50	140	120	4	4
80	65	150	140	8	4
100	80	175	150	8	8

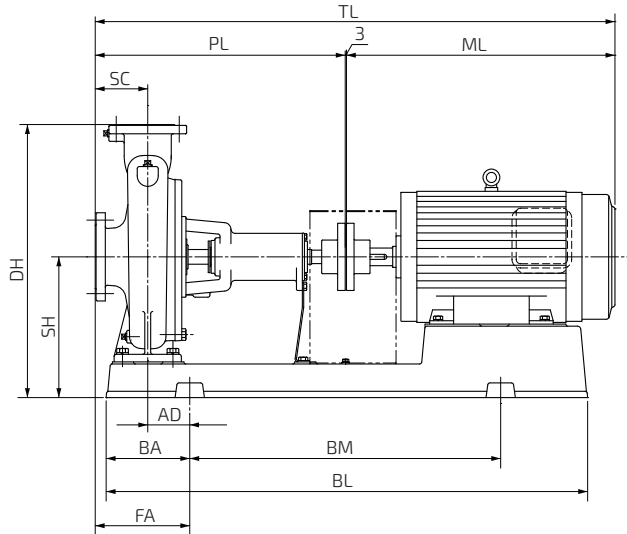
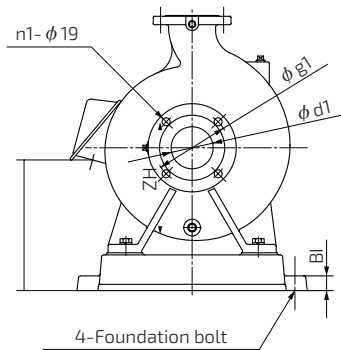
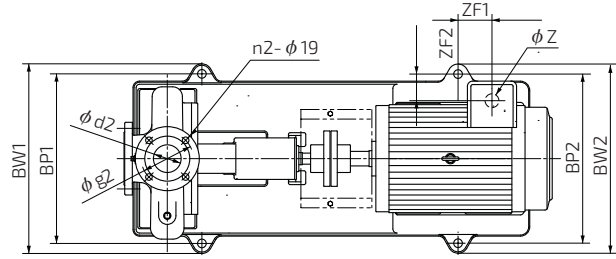

Unit : mm

Suction d1 x Discharge d2 (mm)	Model	Motor (kW)	Combination						Other				Weight (kg)
			DH	SH	TL	AD	FA	ML	ZF1	ZF2	ZH	Z	
40x32	GES-405M-4M0.4	0.4	395	215	679	45	125	236	23	-12	184	22	53
	GES405M4ME0.75	0.75	395	215	746	55	135	281	20	39	205	22	67
50x40	GES505M4ME0.75	0.75	395	215	766	55	155	281	20	54	205	22	69
	GES505M4ME1.5	1.5	470	245	842	55	155	316	-44	27	205	28	83
	GES505M4ME2.2	2.2	470	245	842	55	155	357	-7	20	205	28	94
65x50	GES655M4ME1.5	1.5	415	215	779	55	155	316	17	42	175	28	74
	GES655M4ME2.2	2.2	425	225	820	55	155	357	53	35	185	28	88
	GES655M4ME3.7	3.7	470	245	840	55	155	373	7	22	205	28	109
80x65	GES805M4ME2.2	2.2	470	245	842	55	155	357	-7	20	205	28	97
	GES805M4ME3.7	3.7	470	245	840	55	155	373	7	22	205	28	102
	GES805M4ME5.5	5.5	515	265	1001	60	160	428	111	4	210	36	146
	GES805M4ME7.5	7.5	590	310	1064	80	205	466	69	4	255	36	184
100x80	GES1005M4ME3.7	3.7	495	245	971	75	200	373	37	37	205	28	129
	GES1005M4ME5.5	5.5	590	310	1054	80	205	428	31	4	255	36	173
	GES1005M4ME7.5	7.5	590	310	1064	80	205	466	69	4	255	36	182
	GES1005M4ME11	11	650	335	1172	100	225	563	58	-17	272	52	242
	GES1005M4ME15	15	650	335	1193	100	225	595	90	-17	272	52	265

DRAWING DIMENSION - COMPLETE SET (GES-C)

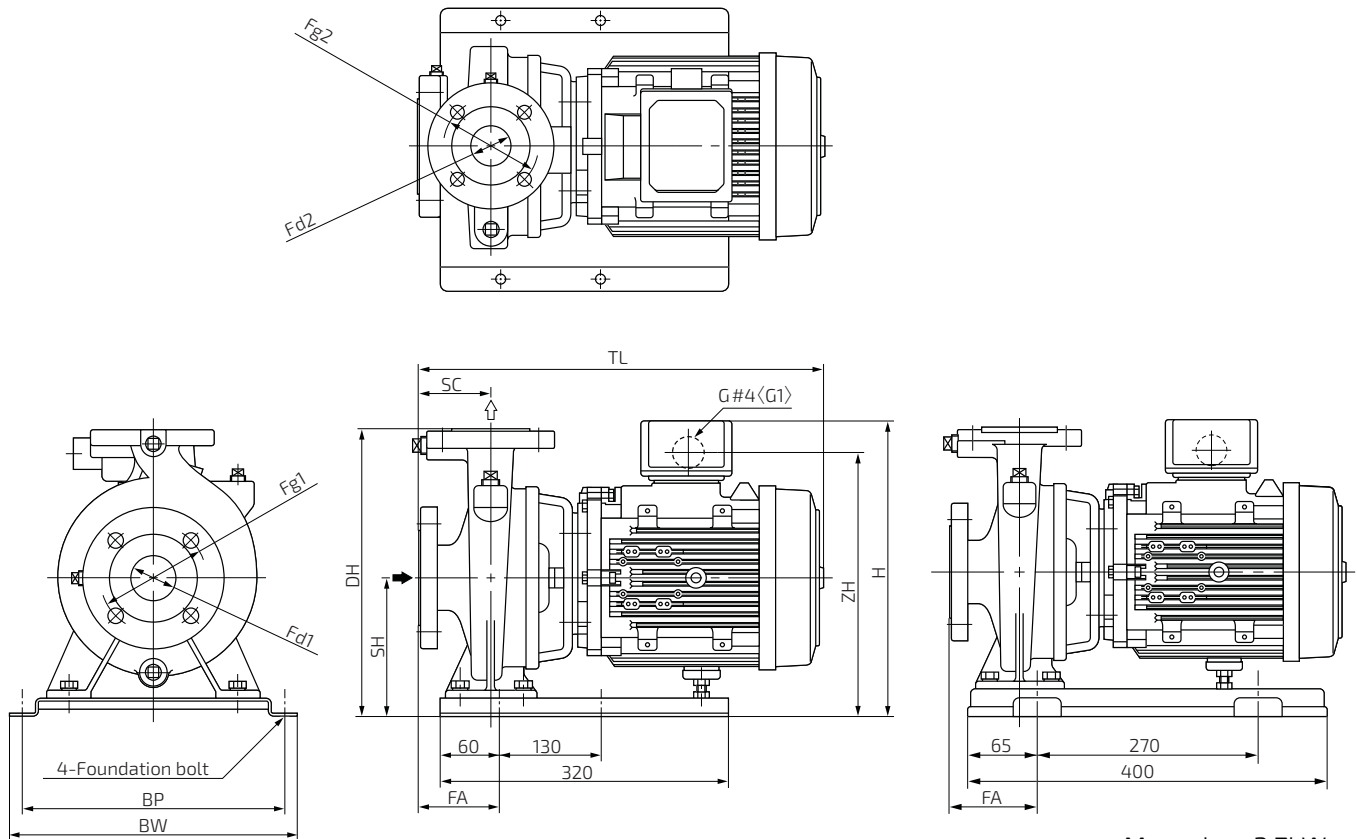

More than 3.7kW

Recommended foundation bolt size : M10 x 125 < >...More than 5.5kW

Unit : mm

Suction (mm)	Discharge (mm)	Model	Motor (kW)	Pump Dimention									Flange				Weight (kg)
				SC	TL	DH	SH	FA	H	BP	BW	ZH	d1	d2	g1	g2	
40	32	GES405CE0.75T4	0.75	65	414	272	132	87	275	230	260	241	40	32	105	100	25
		GES405CE1.5T4	1.5	80	452	312	152	80	-	290	320	272	40	32	105	100	35
		GES405CE2.2T4	2.2	80	447	312	152	80	319	290	320	284	40	32	105	100	41
50	40	GES505CE1.5T4	1.5	80	457	272	132	80	287	230	260	252	50	40	120	105	34
		GES505CE2.2T4	2.2	80	452	312	152	80	319	290	320	284	50	40	120	105	43
		GES505CE3.7T4	3.7	80	492	327	167	85	334	290	324	299	50	40	120	105	51
		GES505CE5.5T4	5.5	80	559	375	195	85	389	290	324	353	50	40	120	105	73
65	50	GES655CE3.7T4	3.7	80	492	327	167	85	334	290	324	299	65	50	140	120	52
		GES655CE5.5T4	5.5	100	579	375	195	105	389	350	384	353	65	50	140	120	75
		GES655CE7.5T4	7.5	100	595	375	195	105	400	350	384	365	65	50	140	120	94

EXPECTED PERFORMANCE CURVE (GES-2M)

MODEL : GES405M2ME0.75

■ PERFORMANCE CURVES

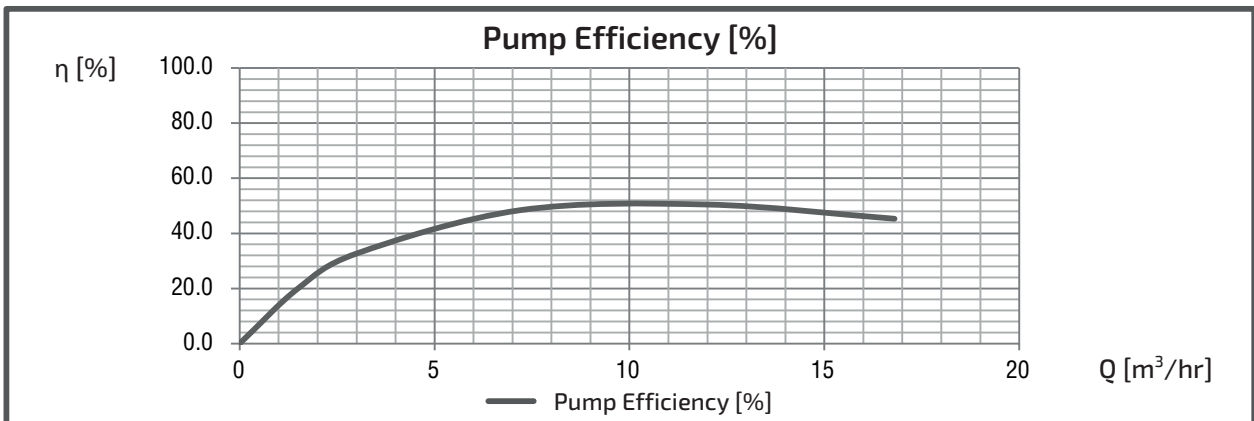
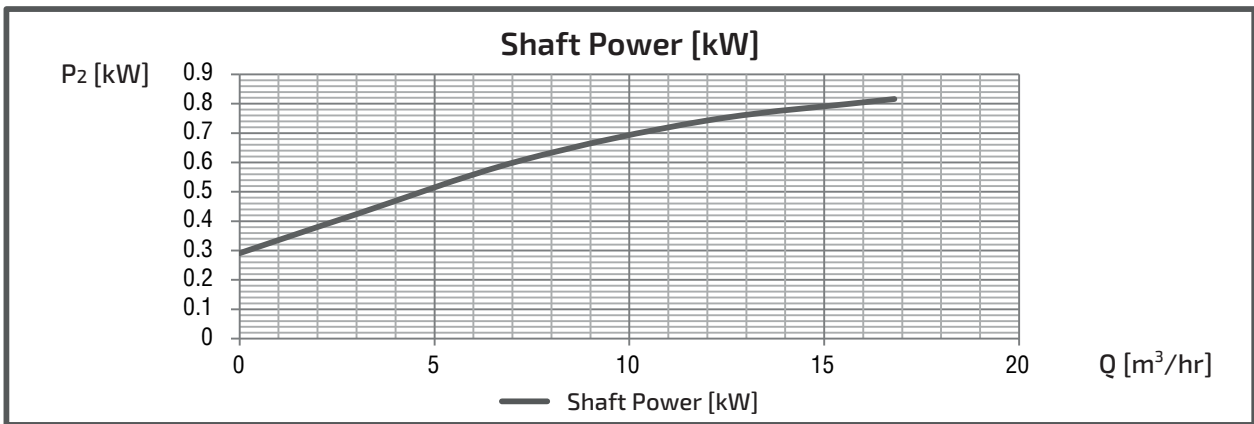
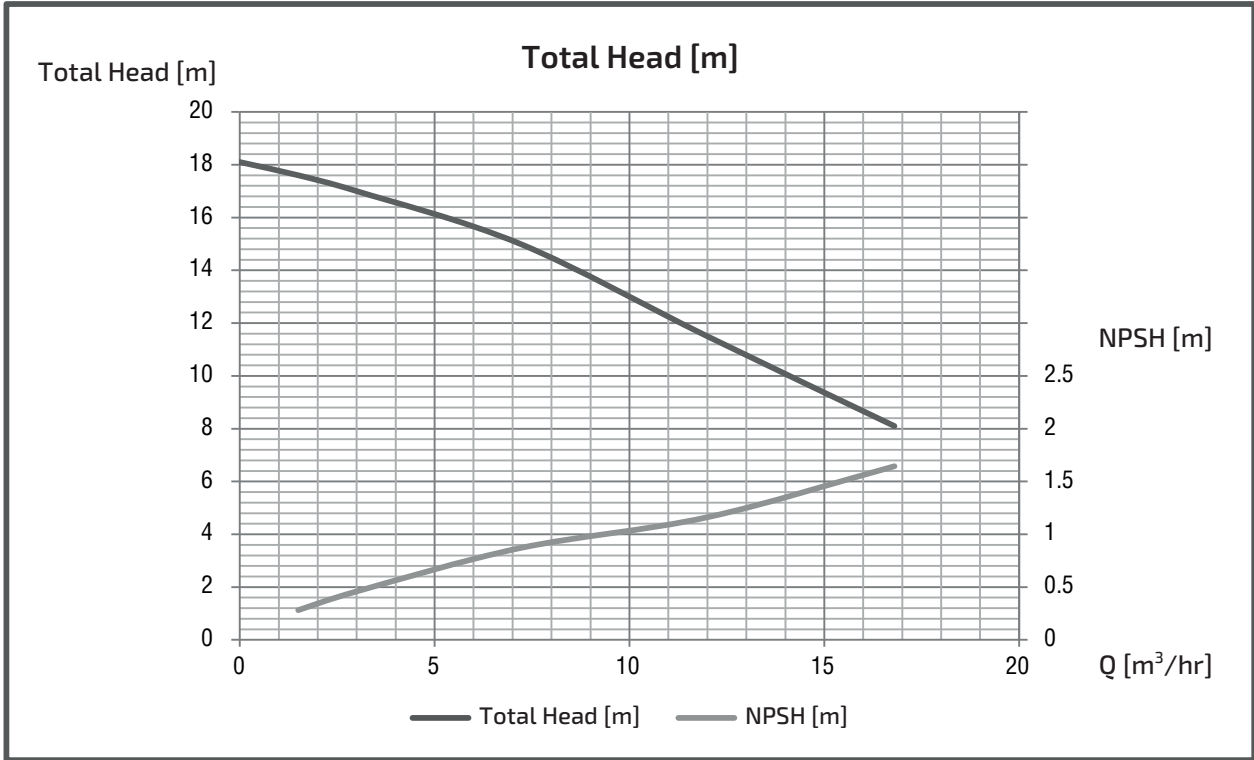

EXPECTED PERFORMANCE CURVE (GES-2M)

MODEL : GES405M2ME1.5

■ PERFORMANCE CURVES

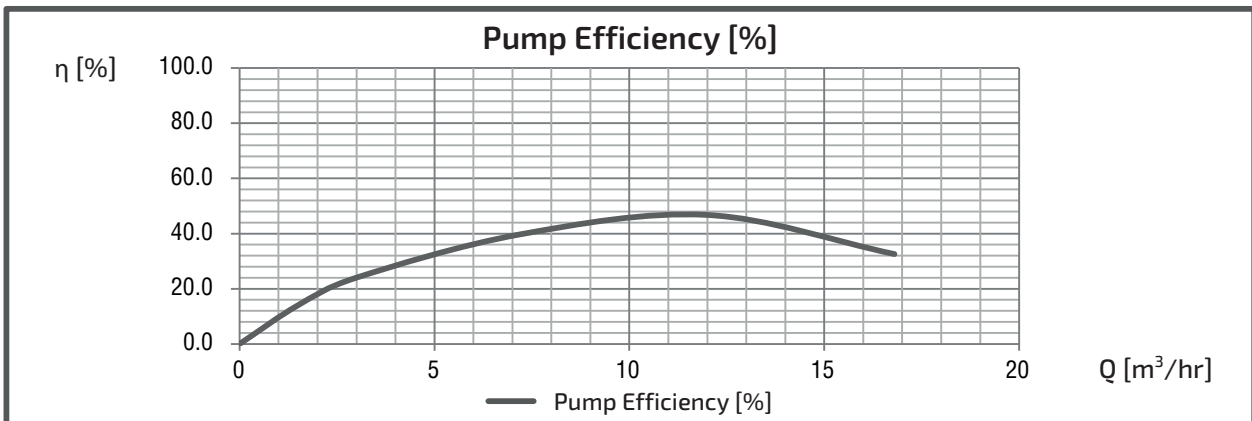
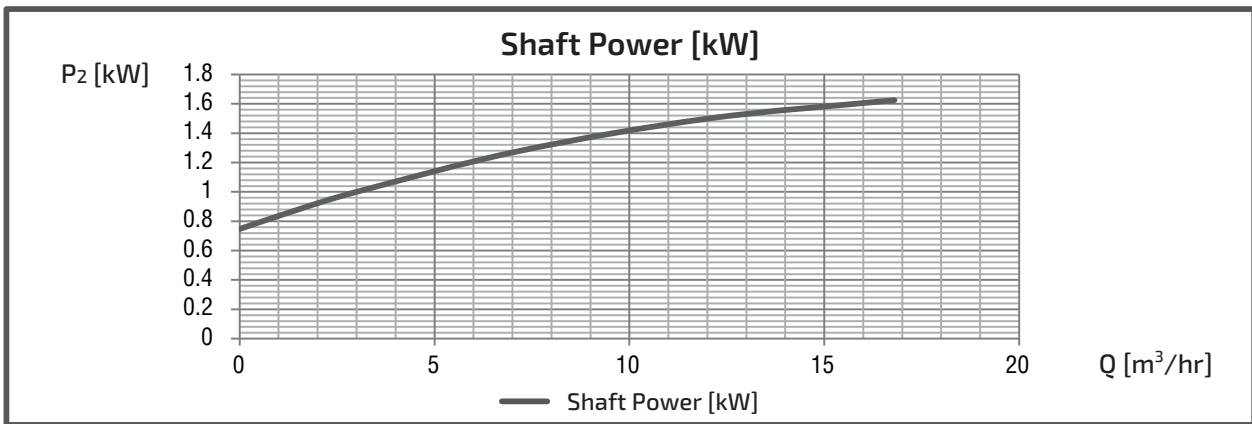
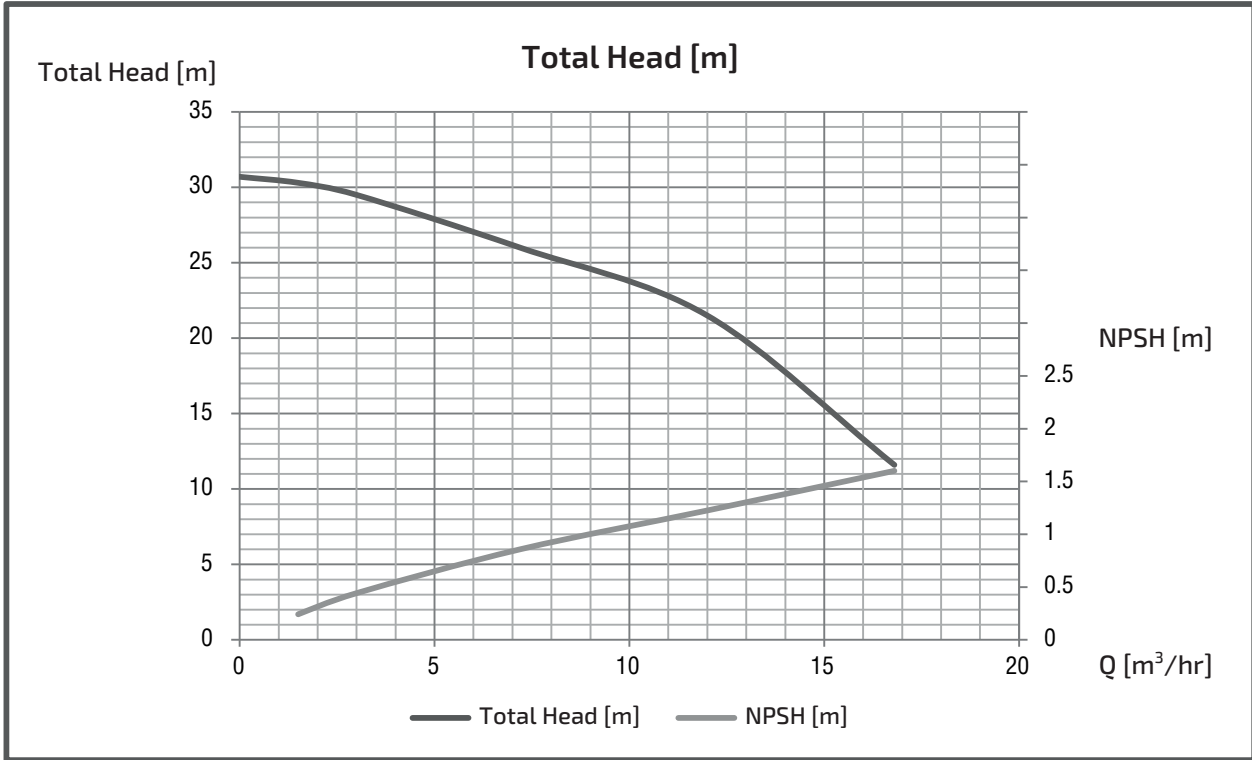

EXPECTED PERFORMANCE CURVE (GES-2M)

MODEL : GES405M2ME2.2

■ PERFORMANCE CURVES

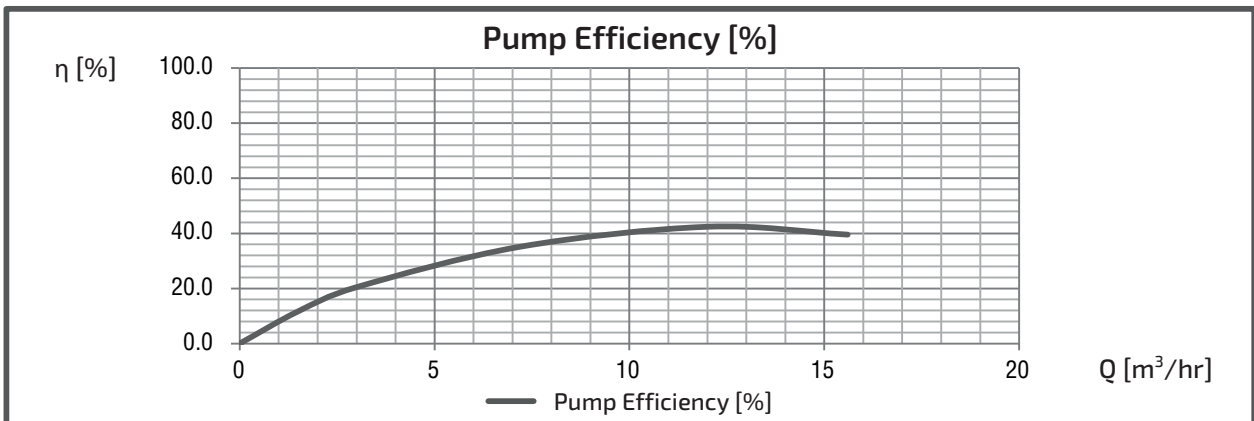
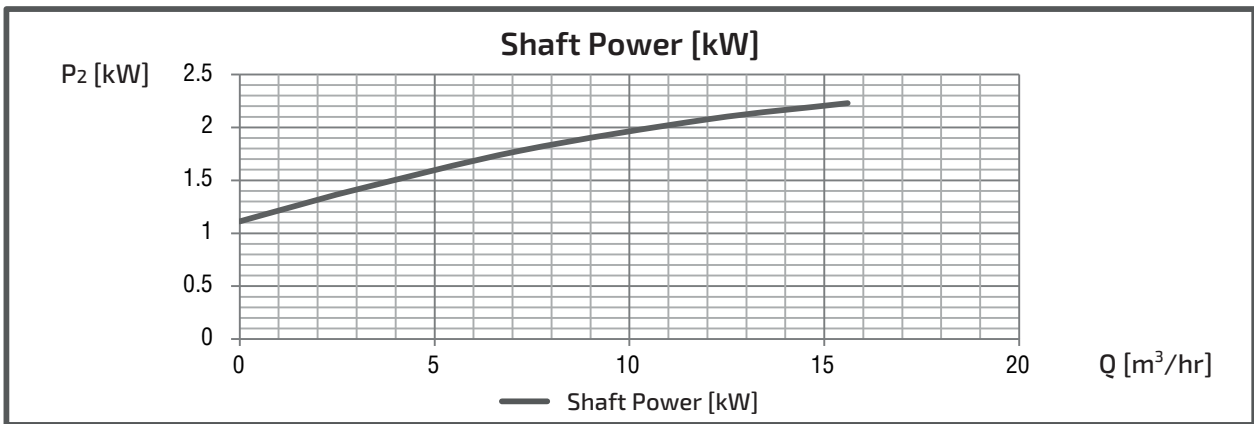
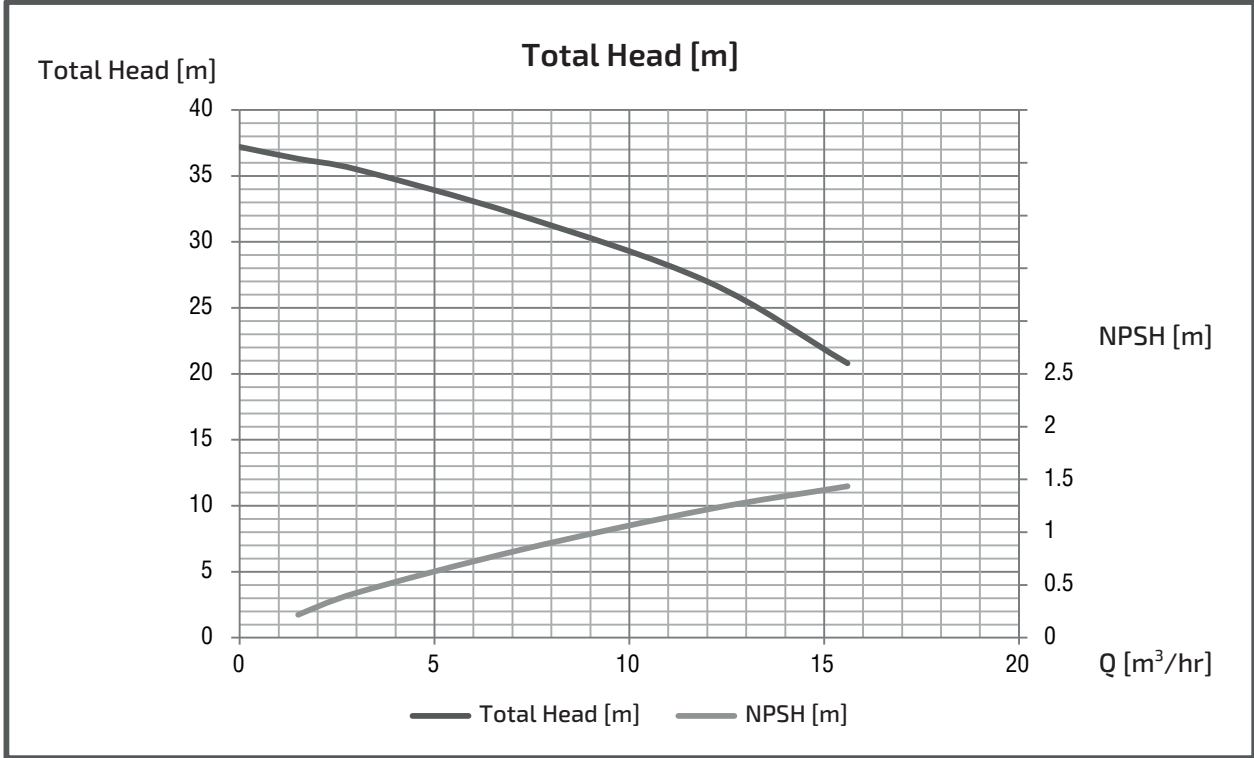

EXPECTED PERFORMANCE CURVE (GES-2M)

MODEL : GES505M2ME1.5

■ PERFORMANCE CURVES

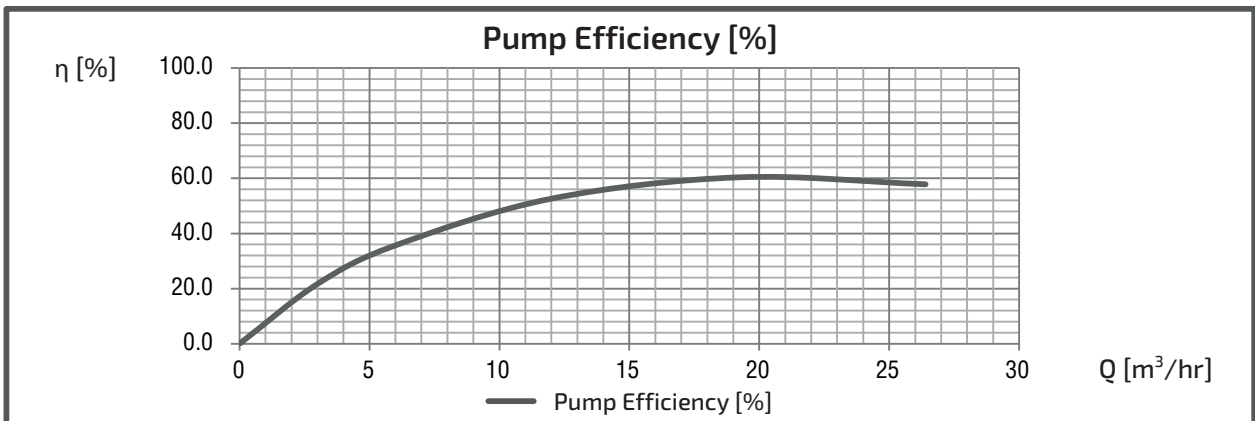
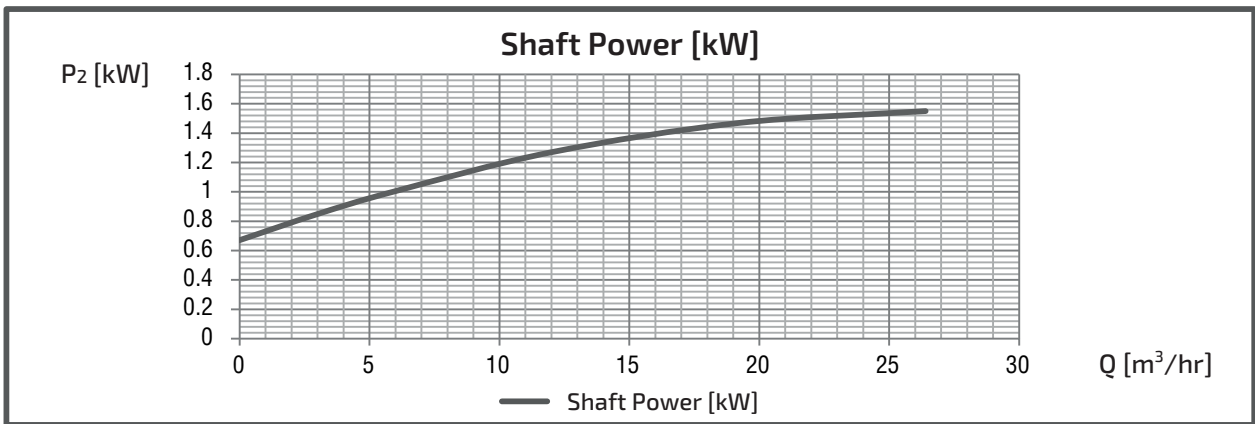
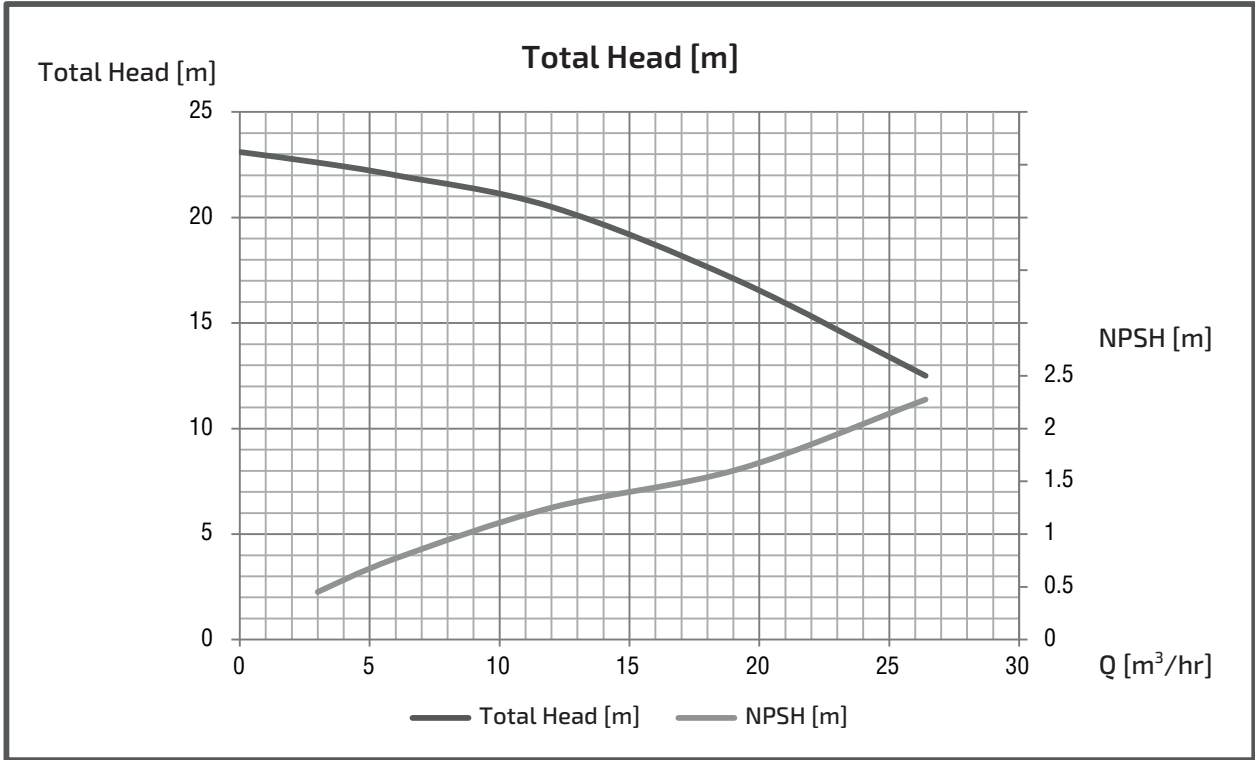

EXPECTED PERFORMANCE CURVE (GES-2M)

MODEL : GES505M2ME2.2

■ PERFORMANCE CURVES

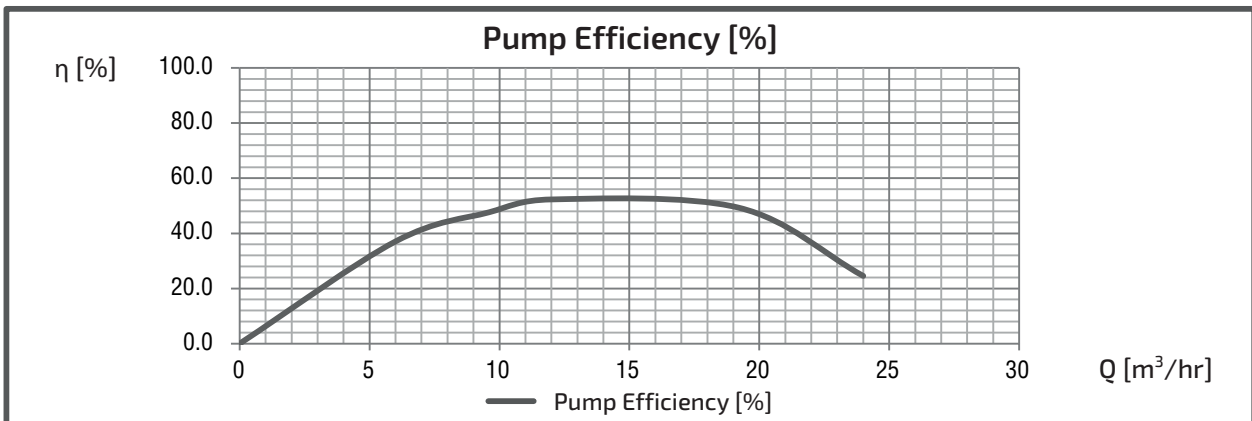
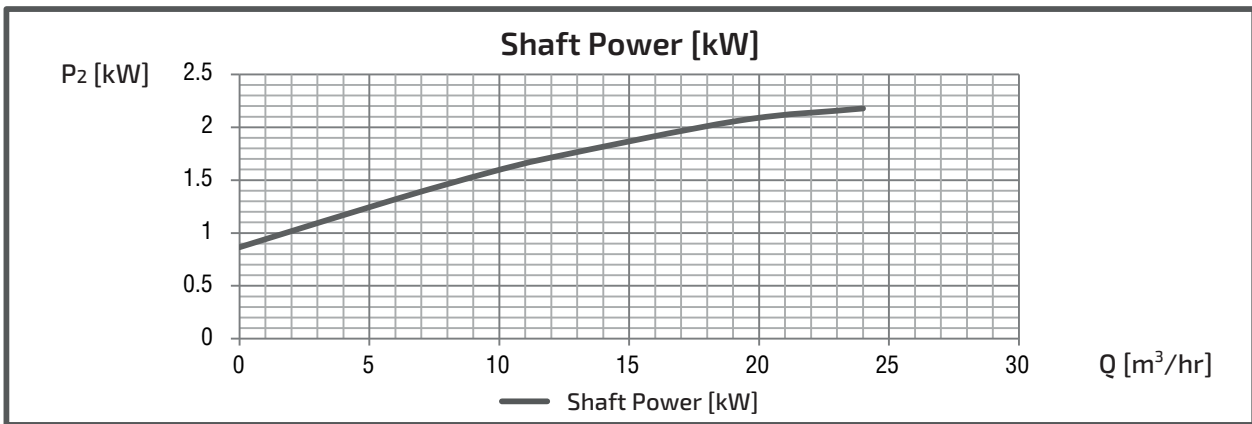
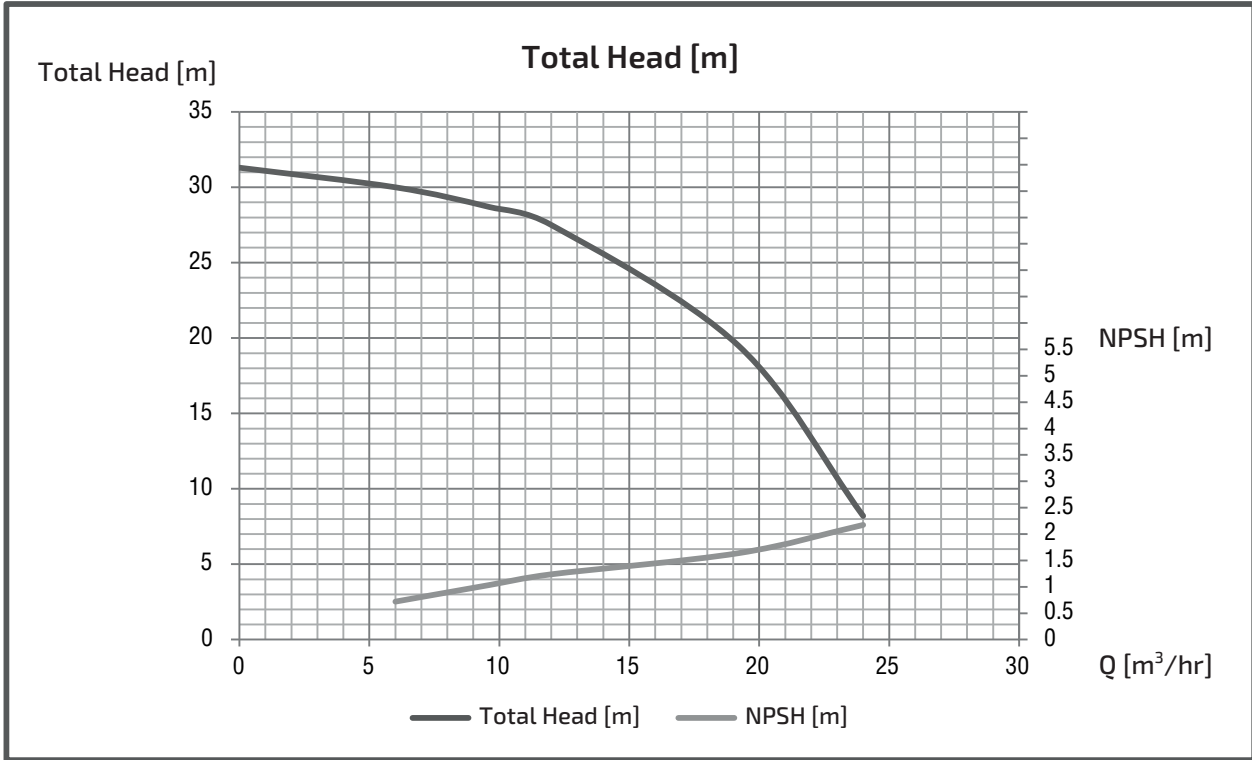

EXPECTED PERFORMANCE CURVE (GES-2M)

MODEL : GES505M2ME3.7

■ PERFORMANCE CURVES

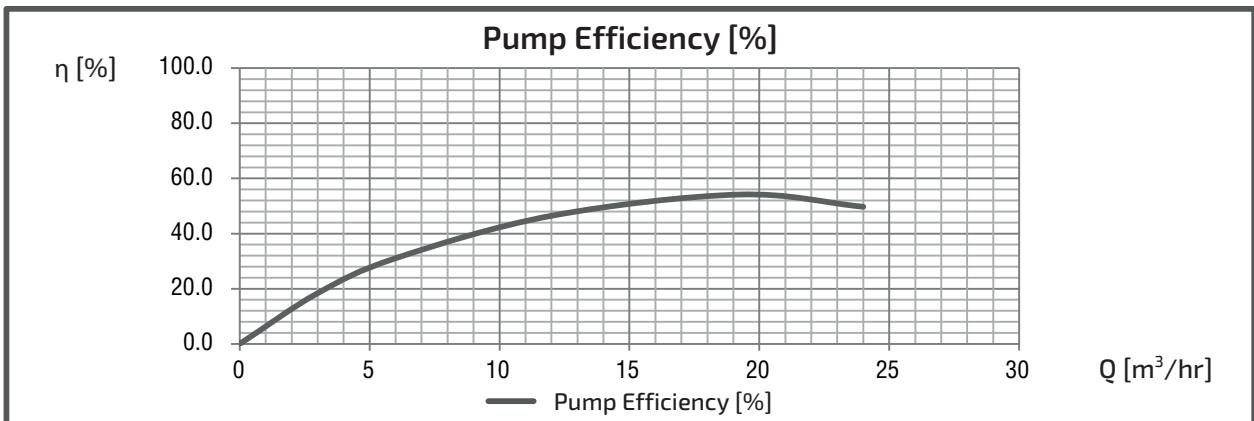
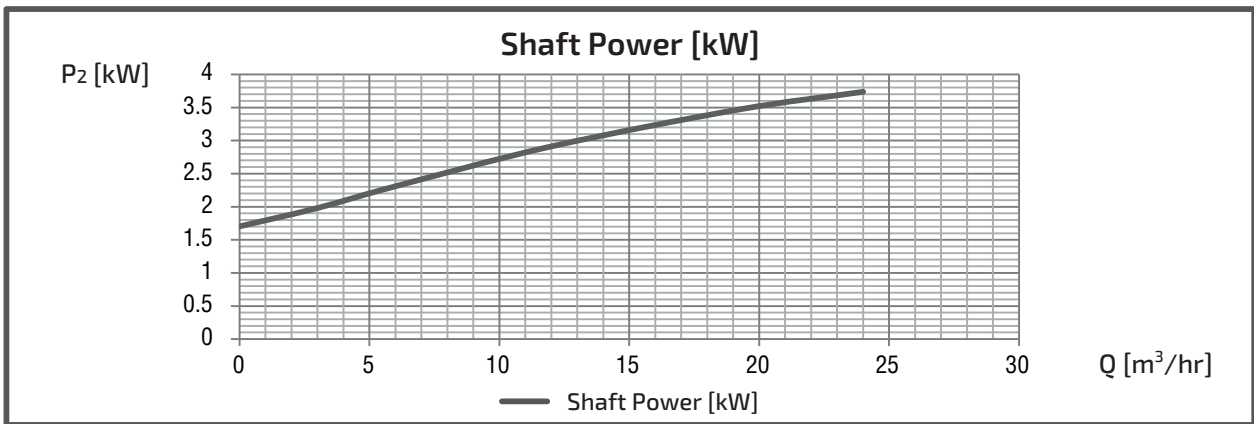
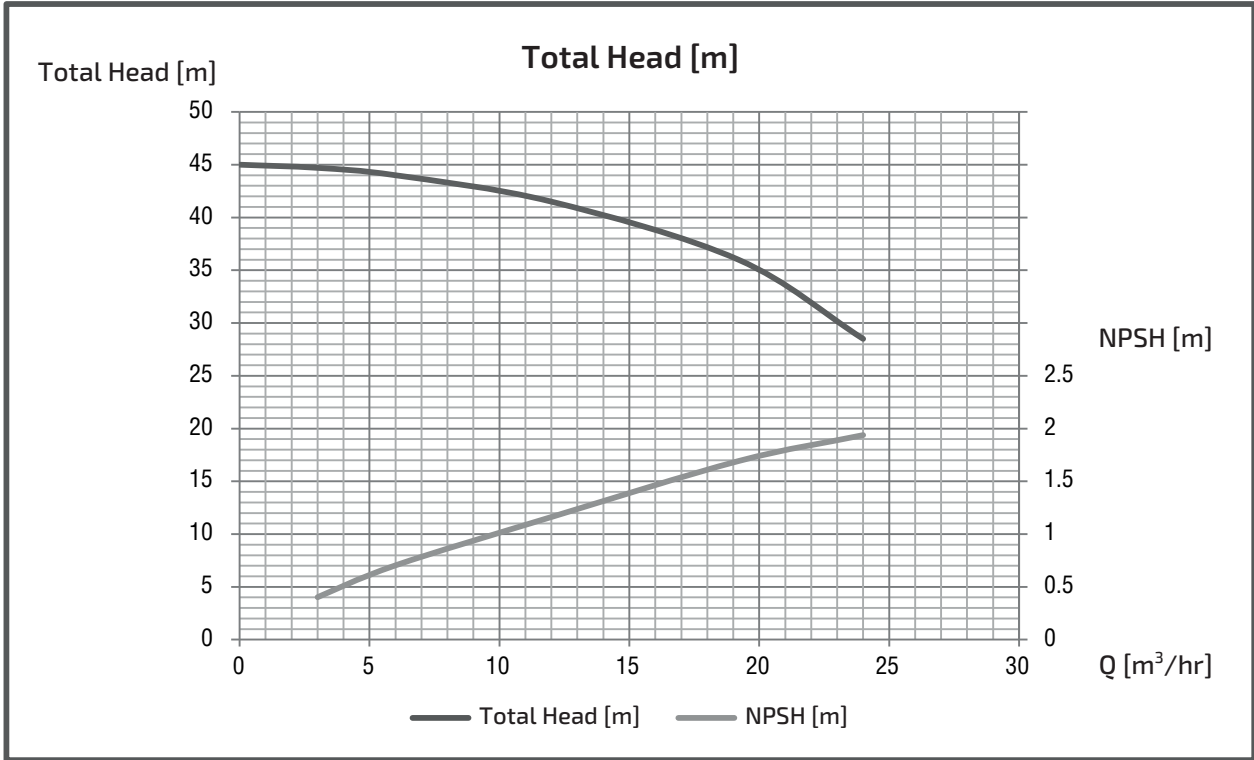

EXPECTED PERFORMANCE CURVE (GES-2M)

MODEL : GES505M2ME5.5

■ PERFORMANCE CURVES

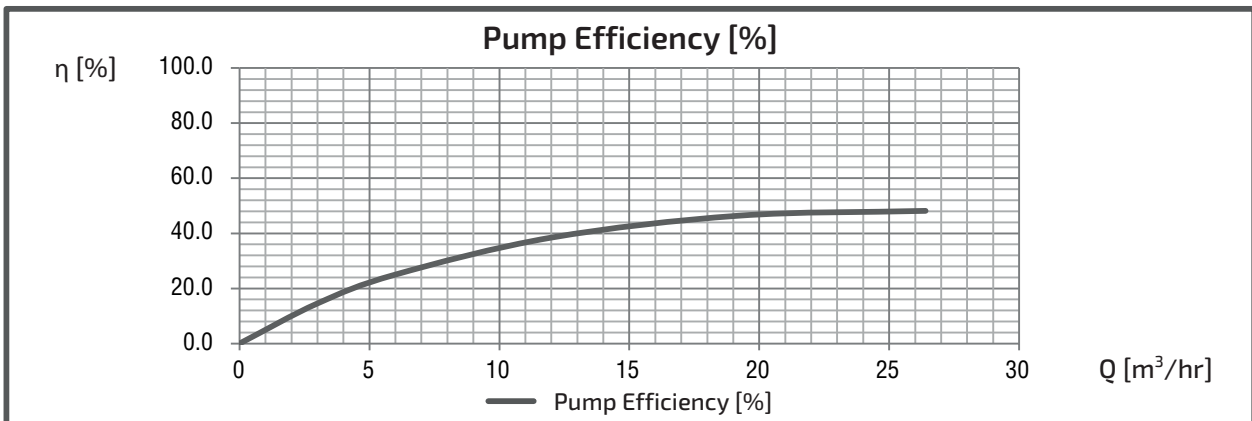
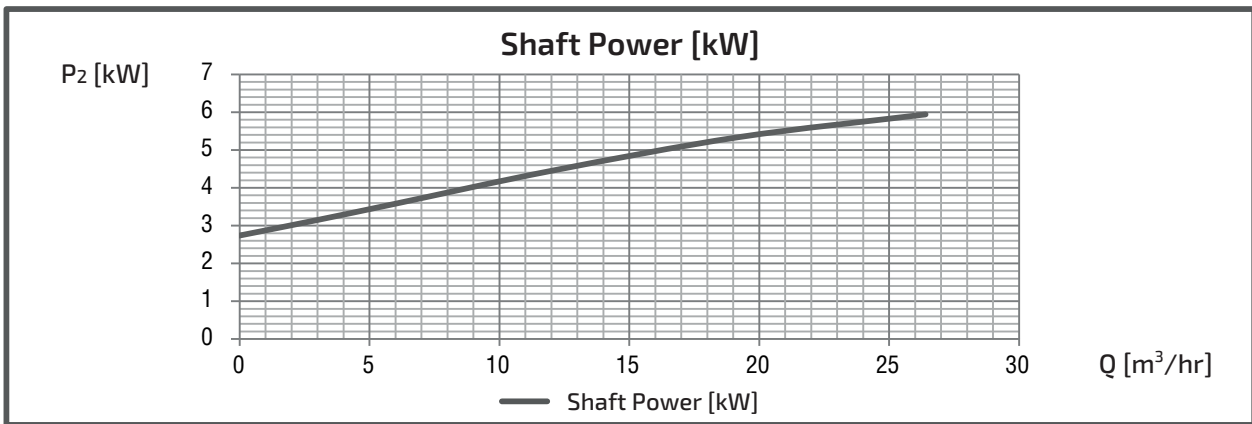
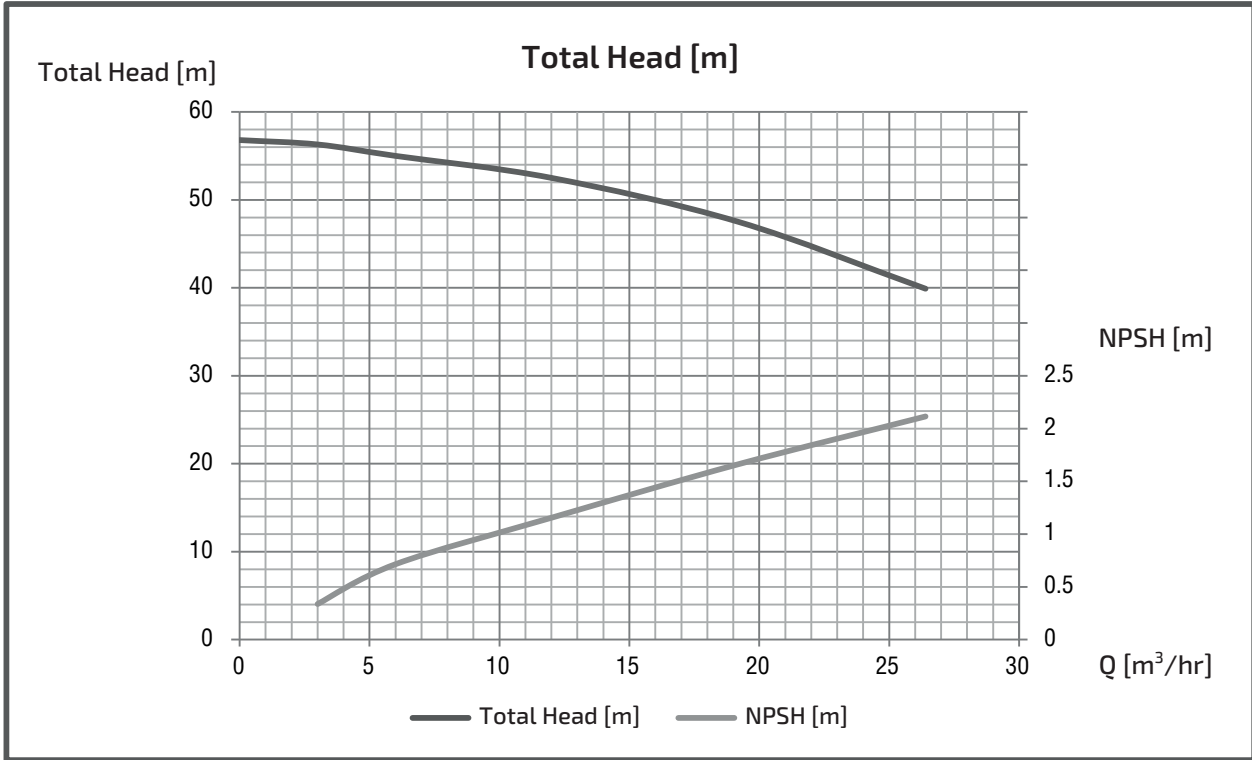

EXPECTED PERFORMANCE CURVE (GES-2M)

MODEL : GES655M2ME3.7

■ PERFORMANCE CURVES

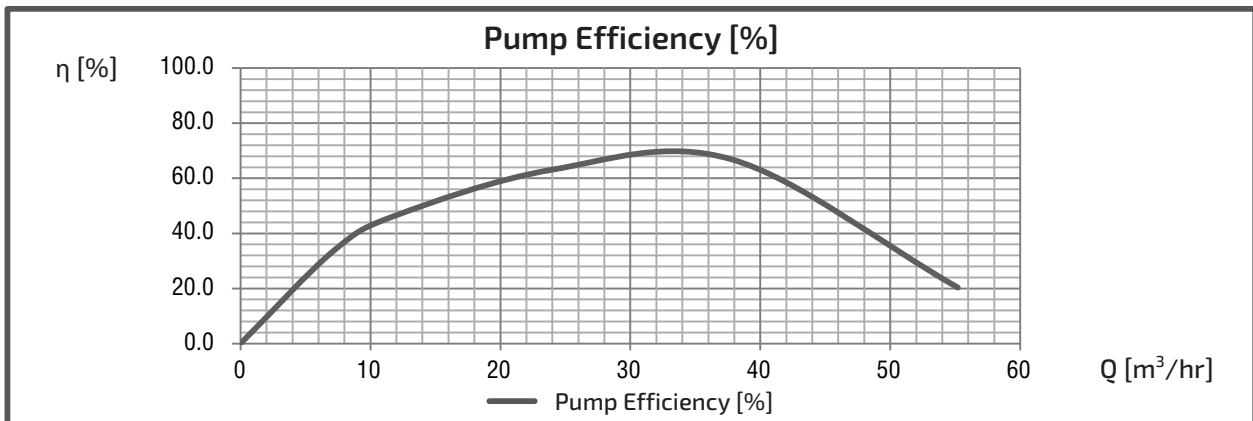
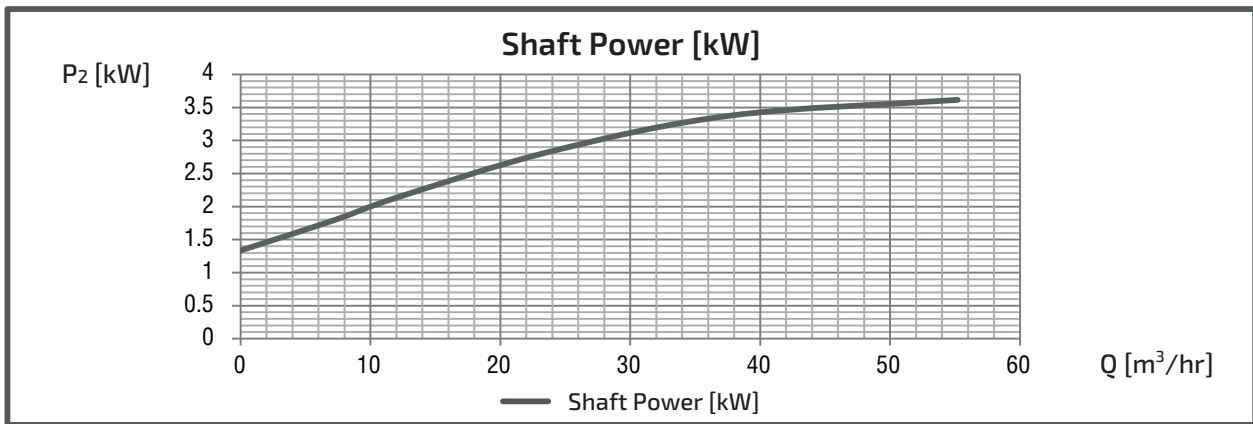
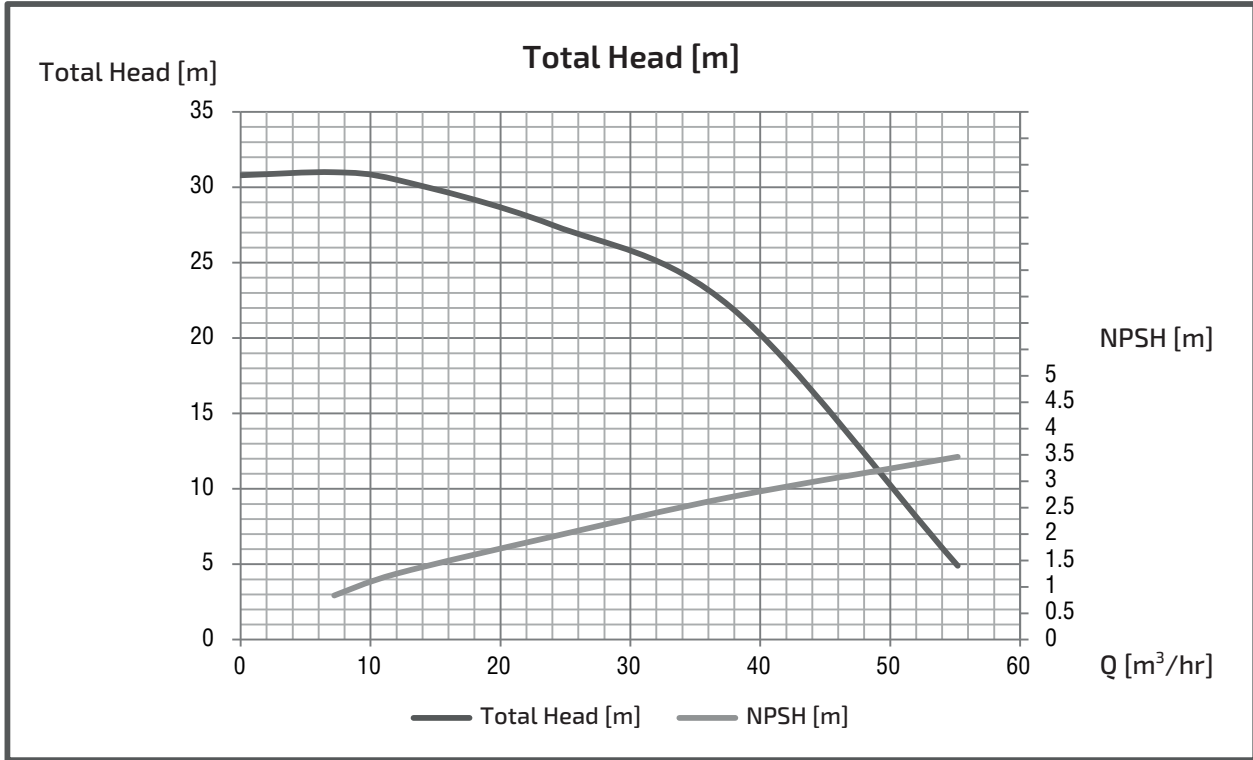

EXPECTED PERFORMANCE CURVE (GES-2M)

MODEL : GES655M2ME5.5

■ PERFORMANCE CURVES

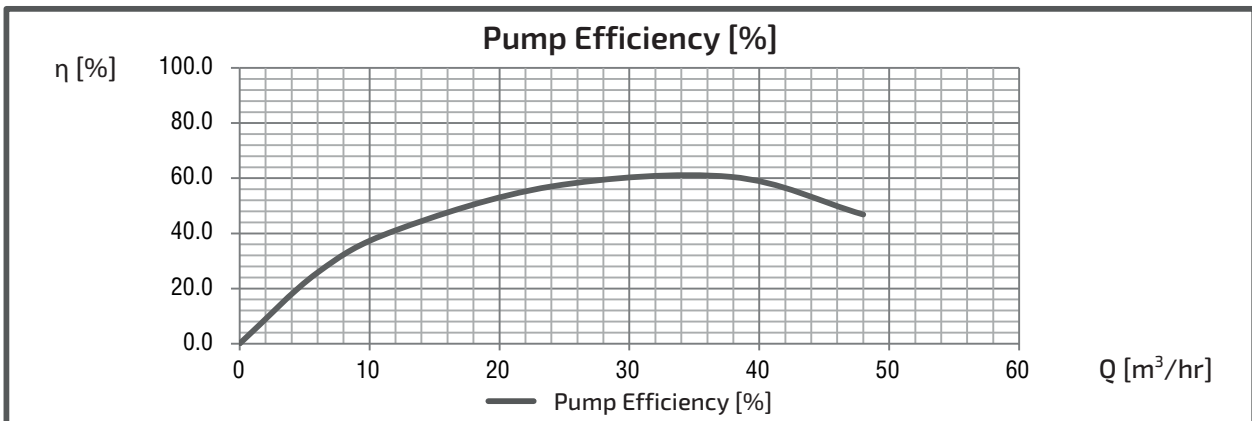
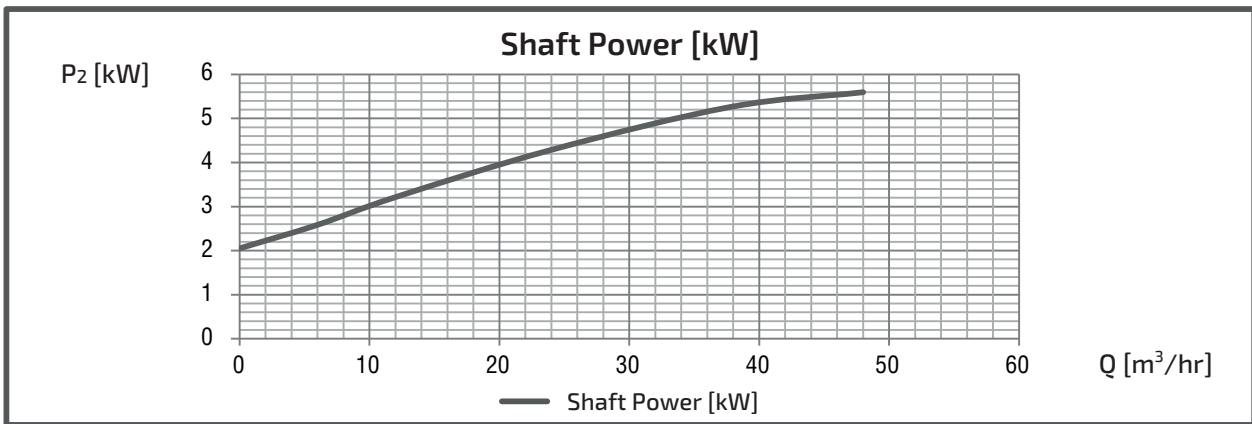
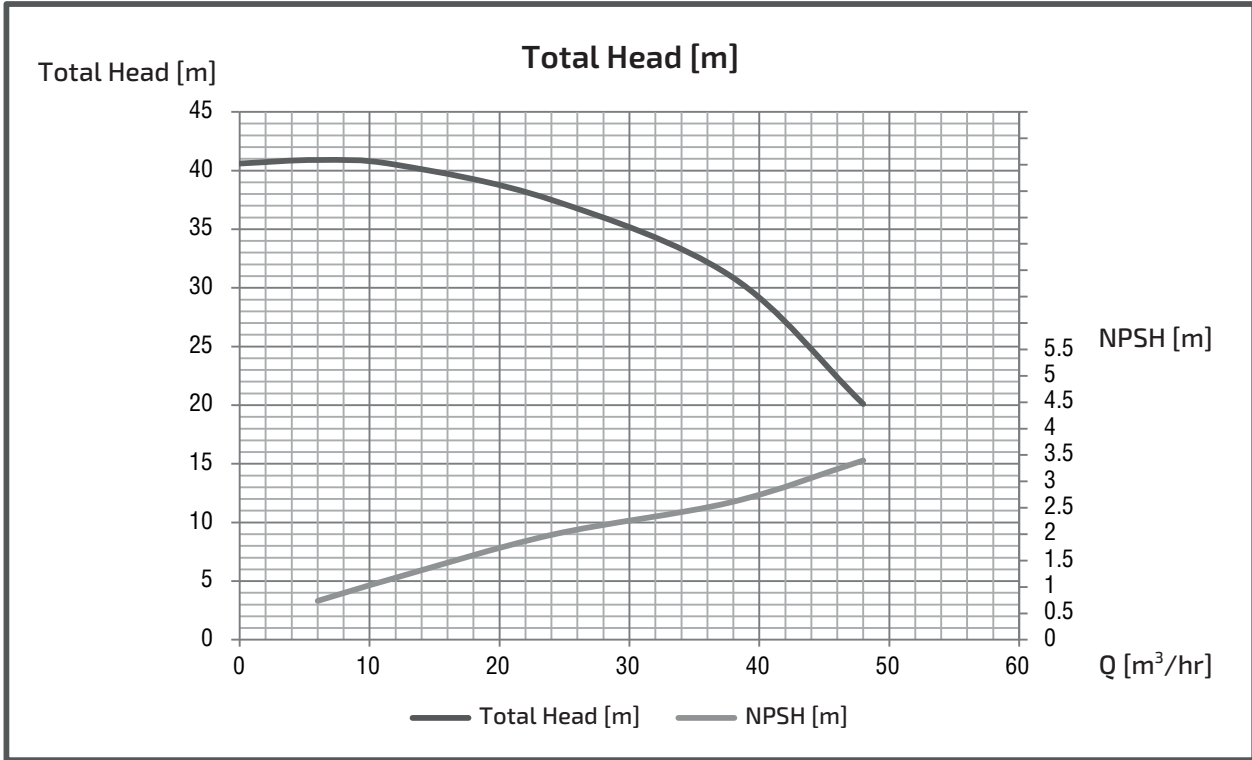

EXPECTED PERFORMANCE CURVE (GES-2M)

MODEL : GES655M2ME7.5

■ PERFORMANCE CURVES

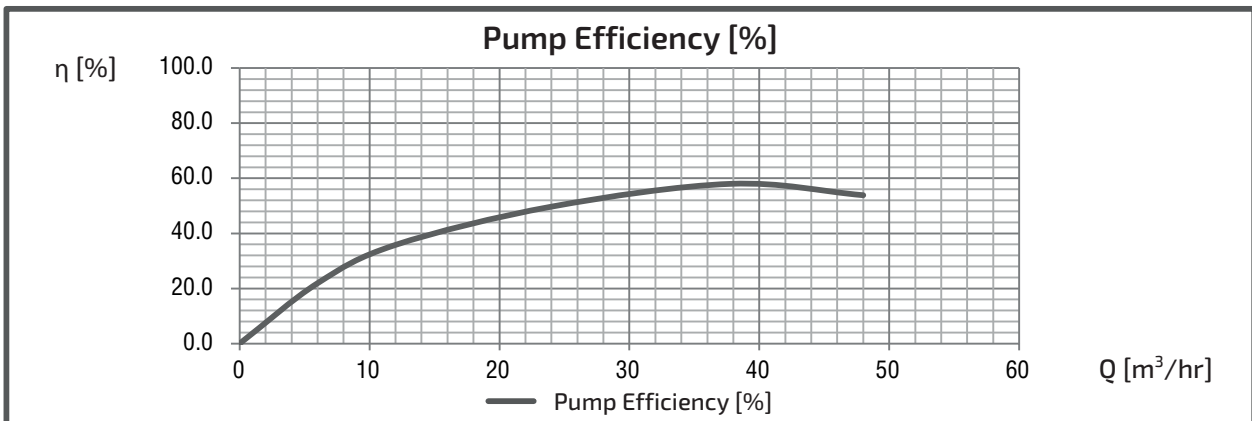
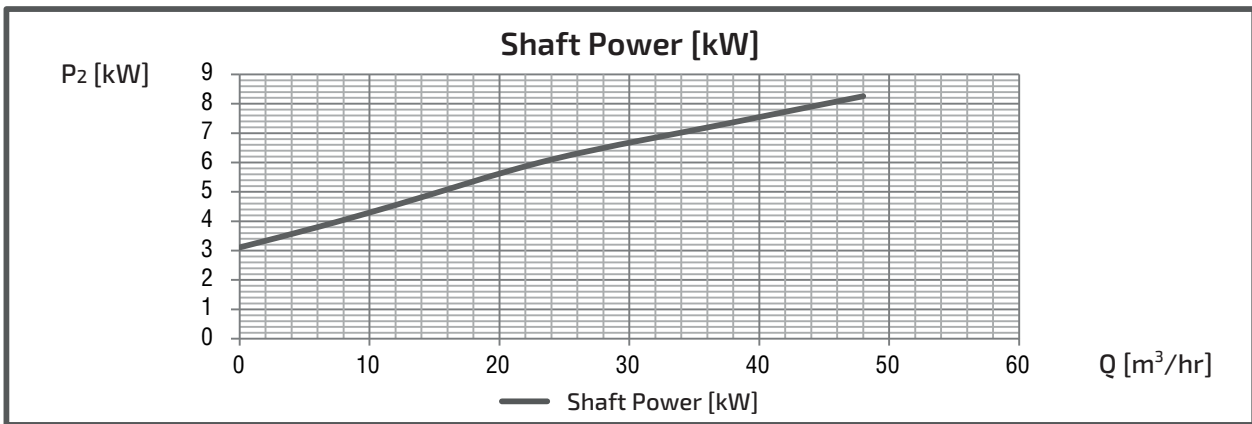
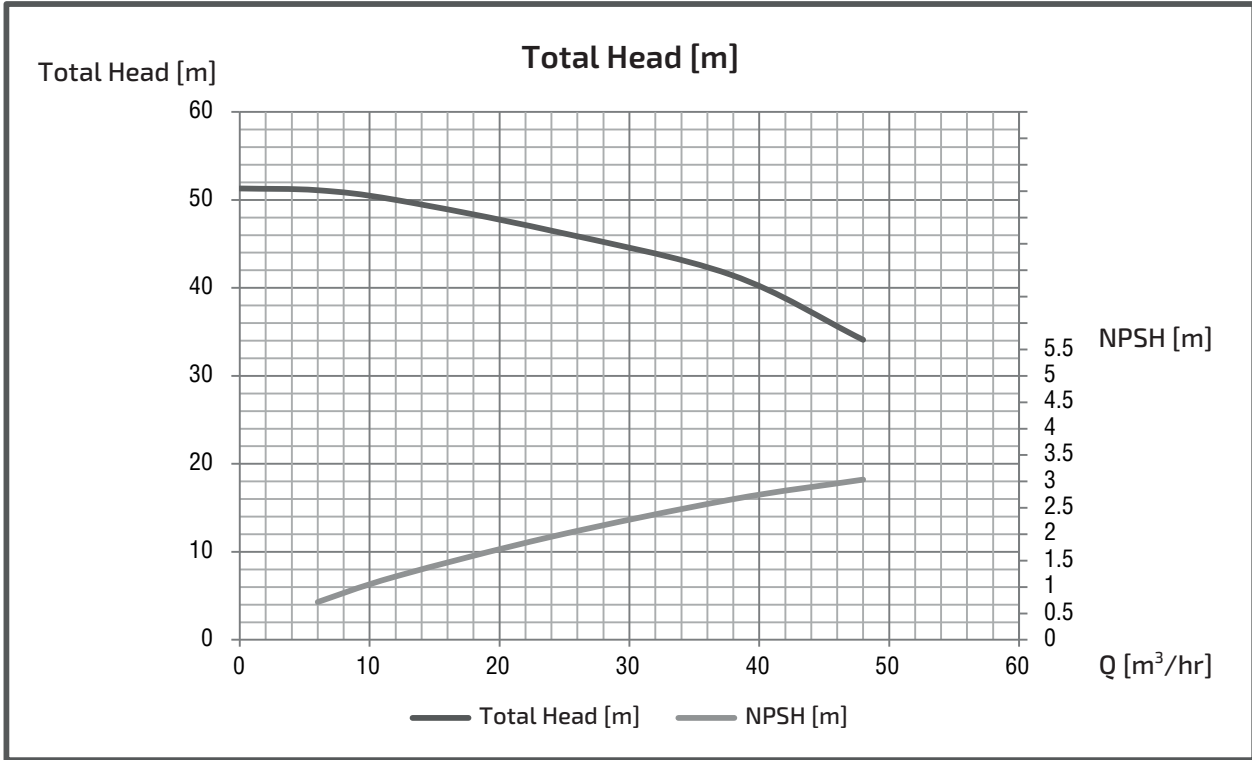

EXPECTED PERFORMANCE CURVE (GES-4M)

MODEL : GES-405M-4M0.4

■ PERFORMANCE CURVES

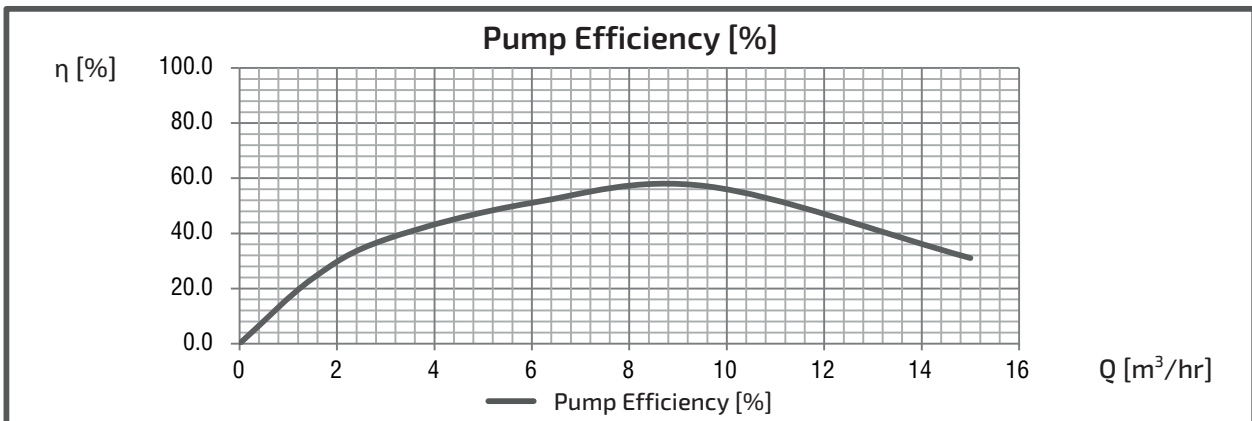
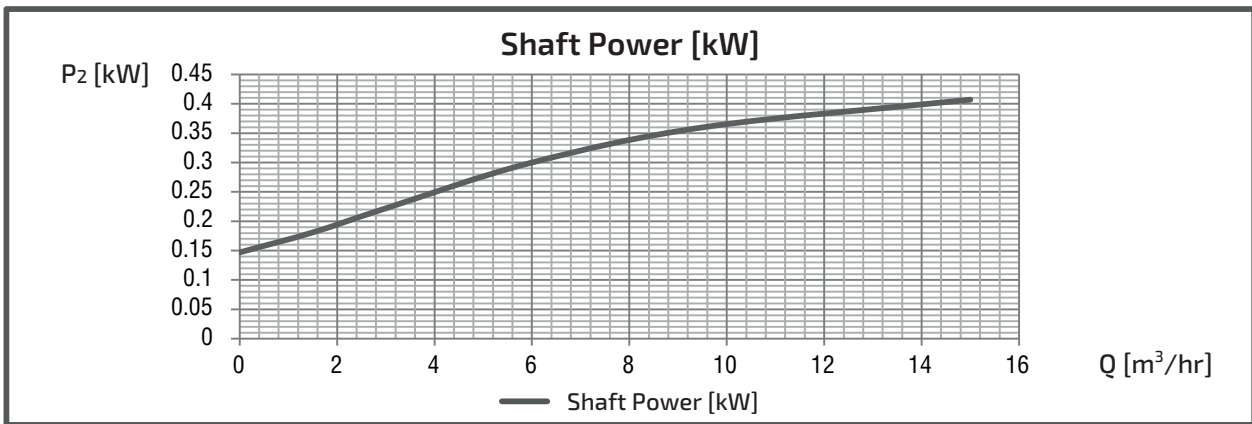
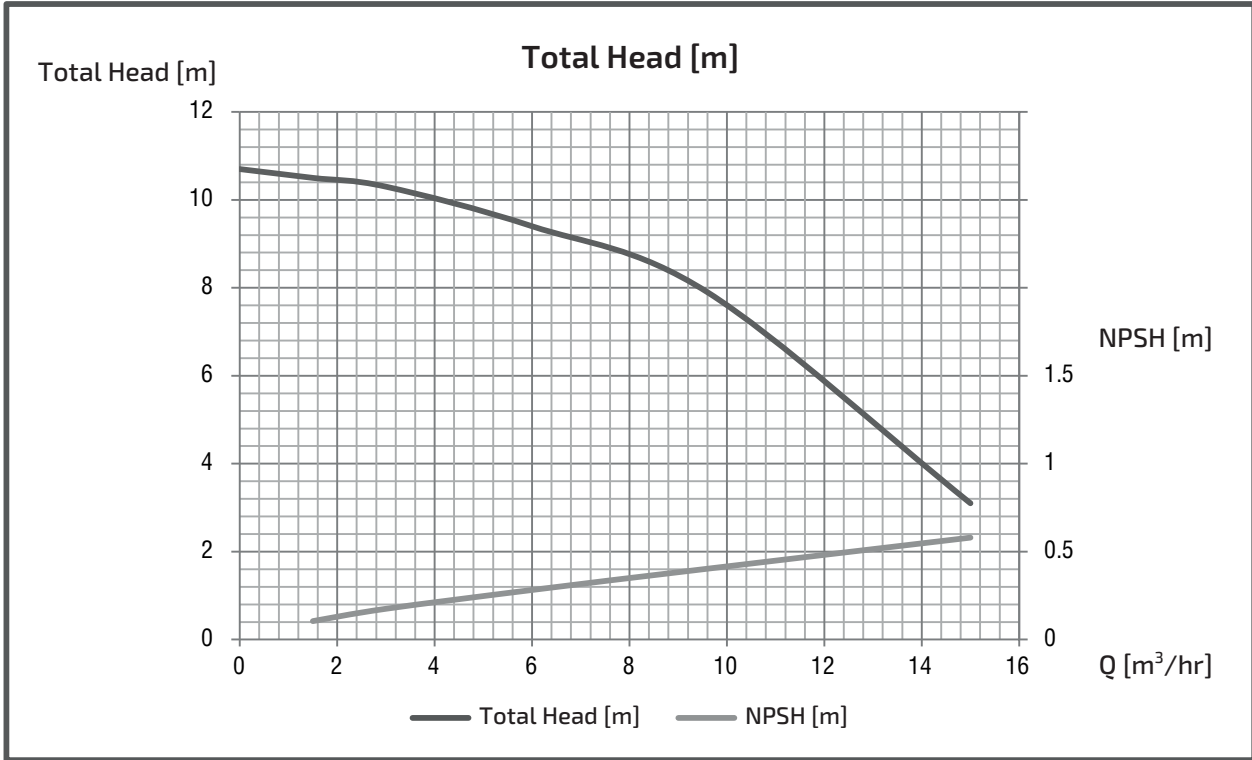

EXPECTED PERFORMANCE CURVE (GES-4M)

MODEL : GES405M4ME0.75

■ PERFORMANCE CURVES

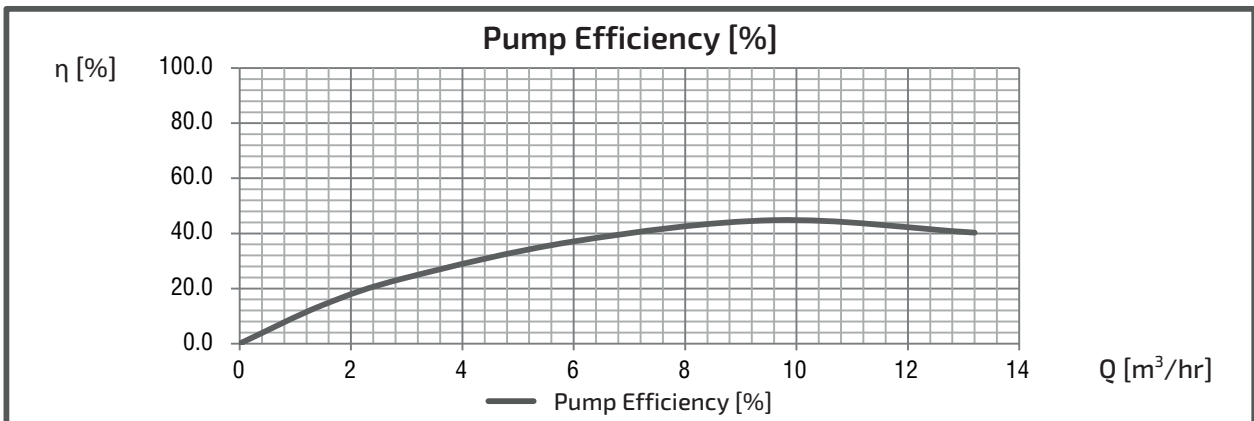
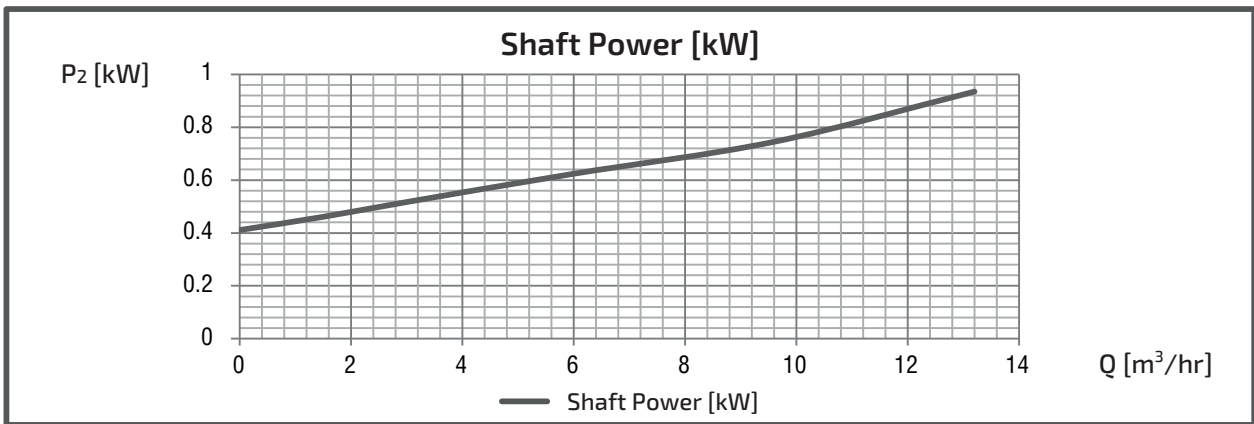
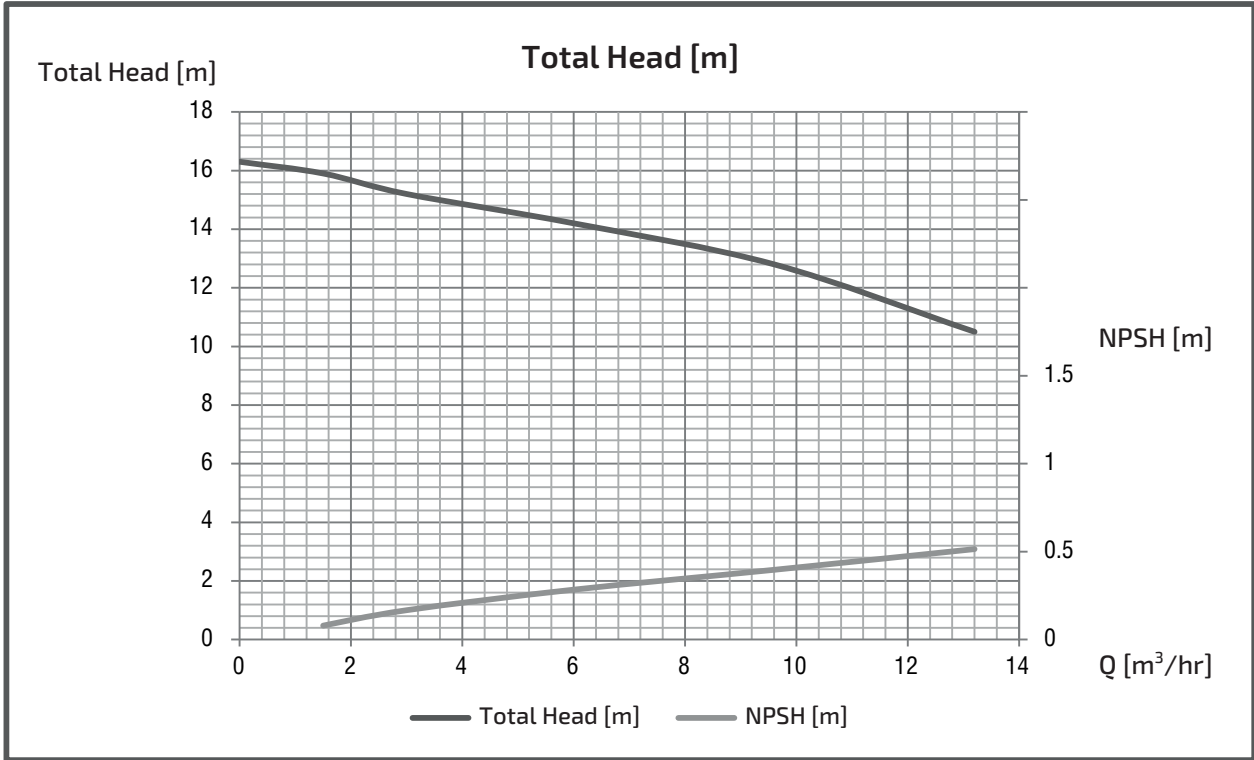

EXPECTED PERFORMANCE CURVE (GES-4M)

MODEL : GES505M4ME0.75

■ PERFORMANCE CURVES

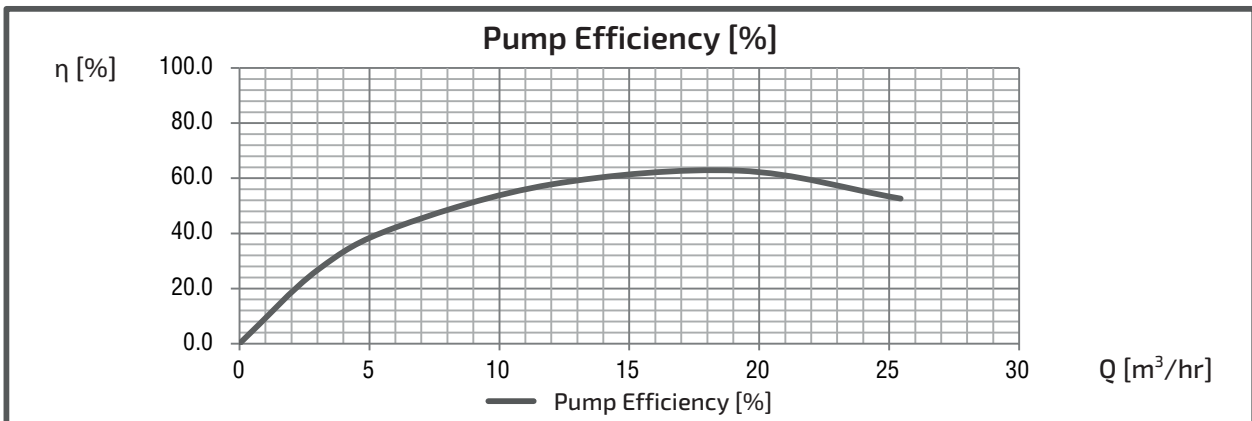
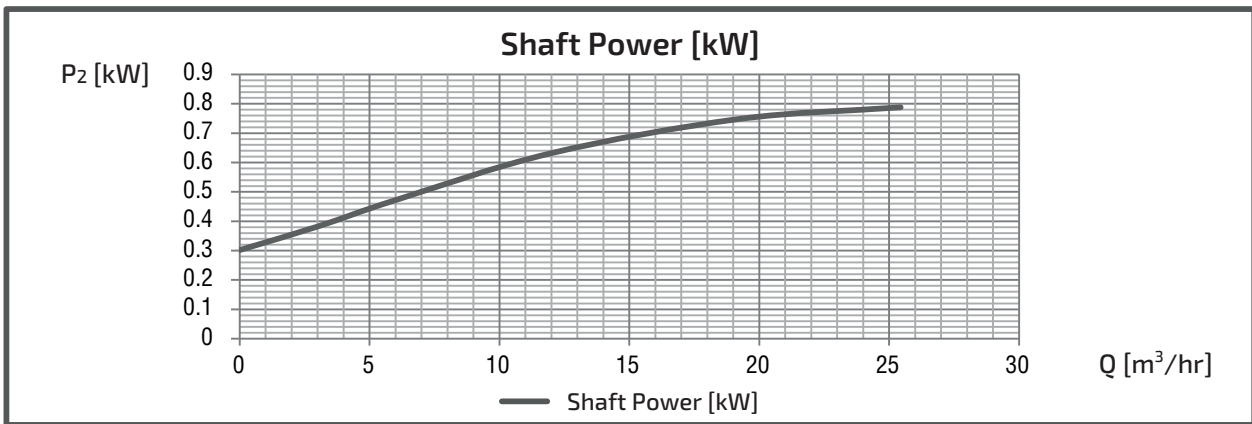
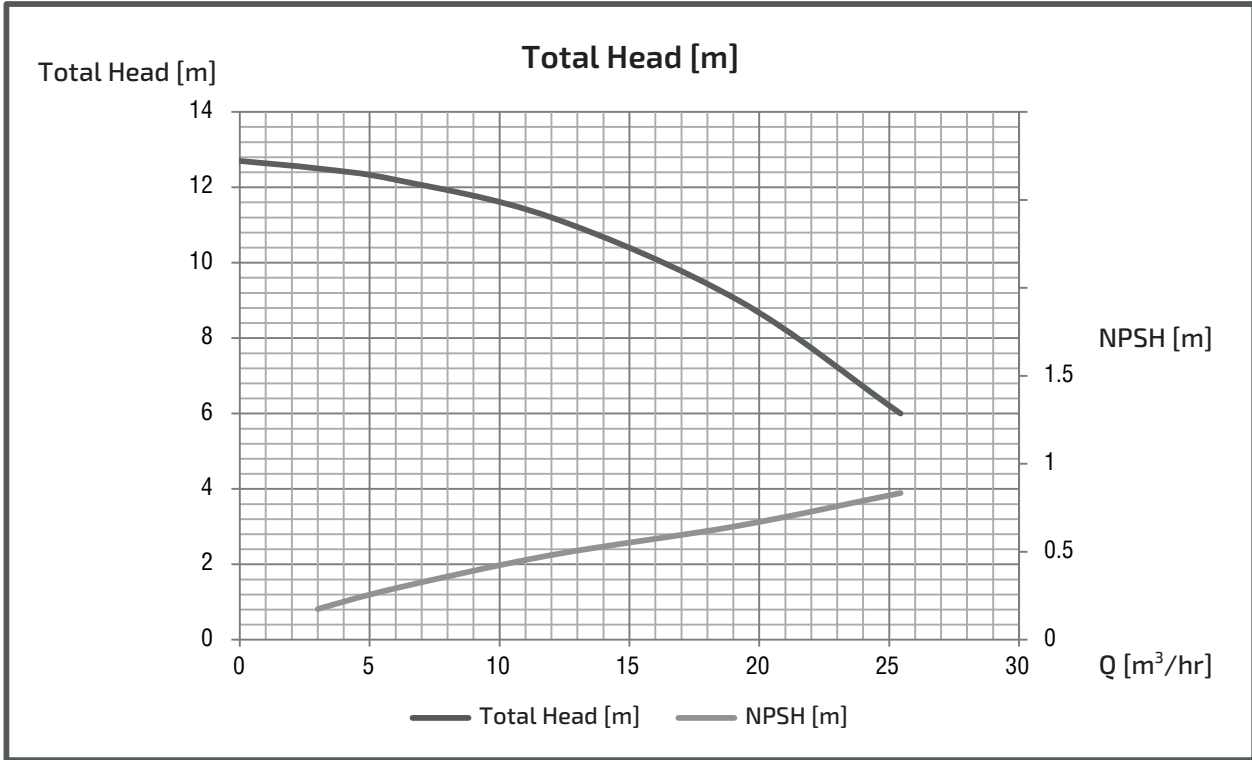

EXPECTED PERFORMANCE CURVE (GES-4M)

MODEL : GES505M4ME1.5

■ PERFORMANCE CURVES

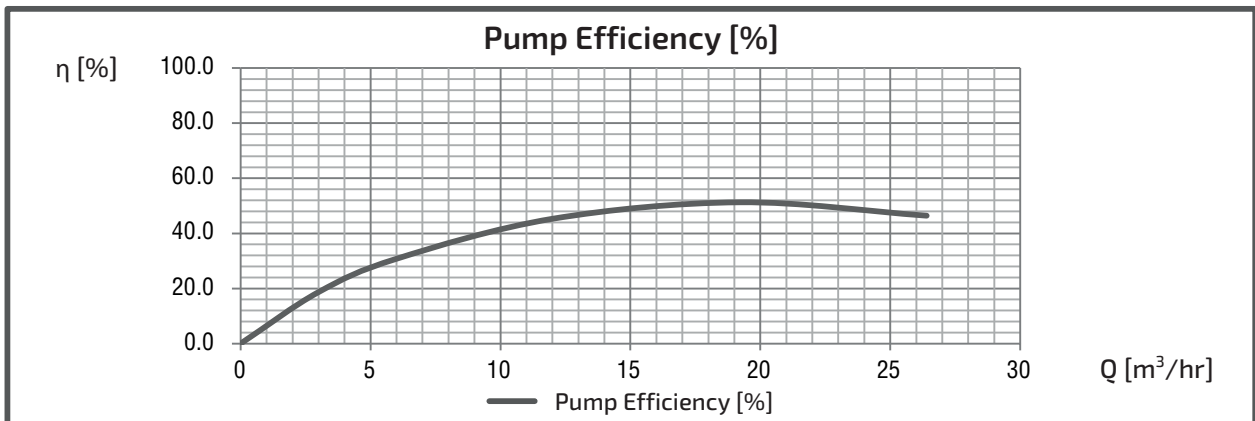
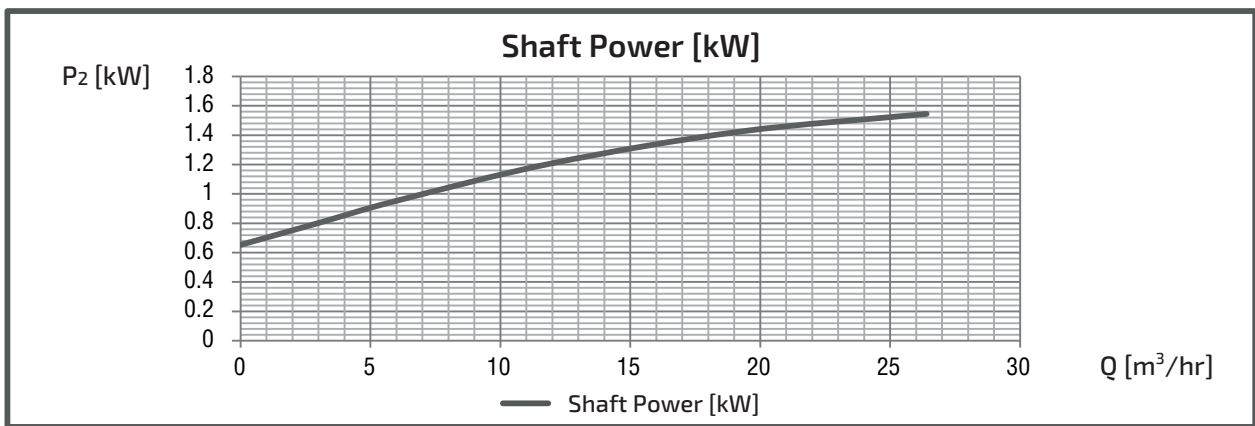
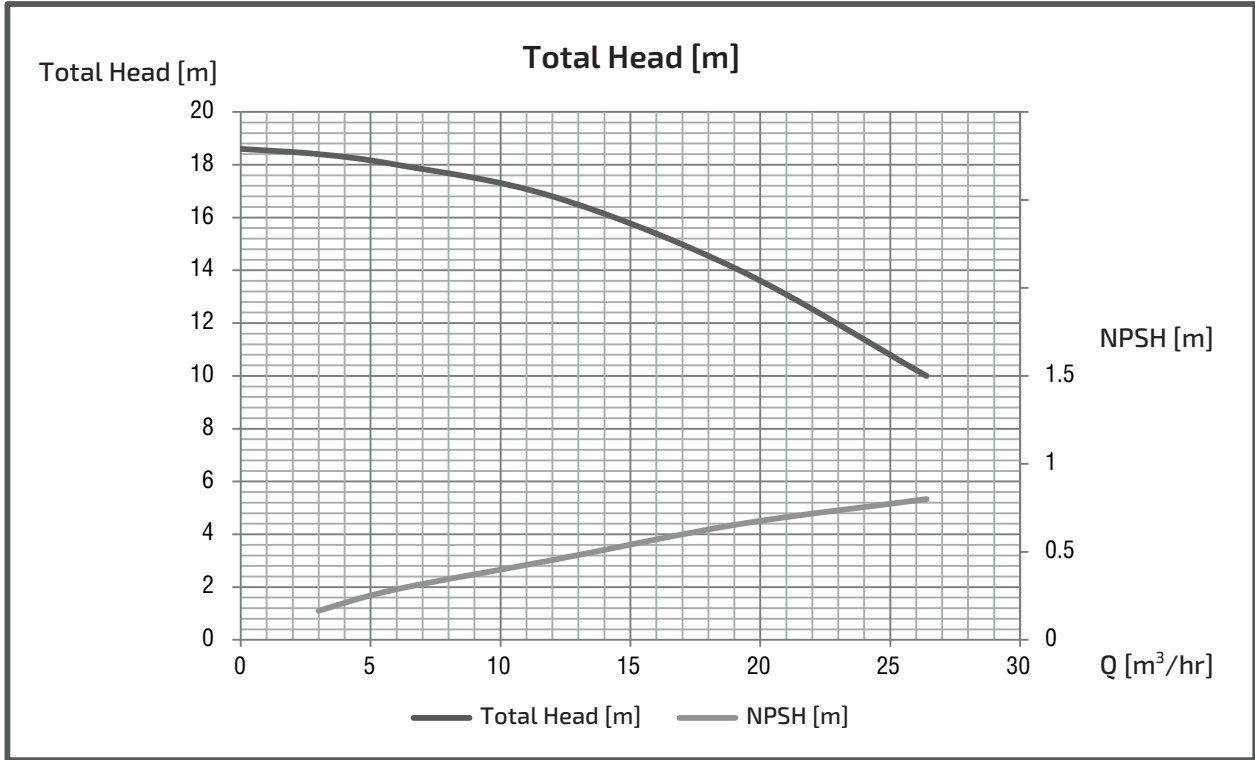

EXPECTED PERFORMANCE CURVE (GES-4M)

MODEL : GES505M4ME2.2

■ PERFORMANCE CURVES

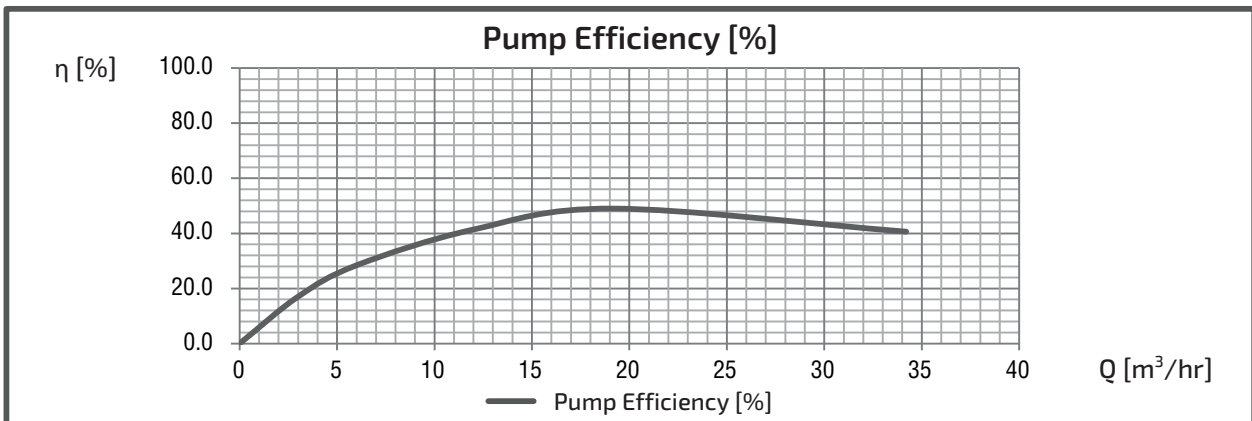
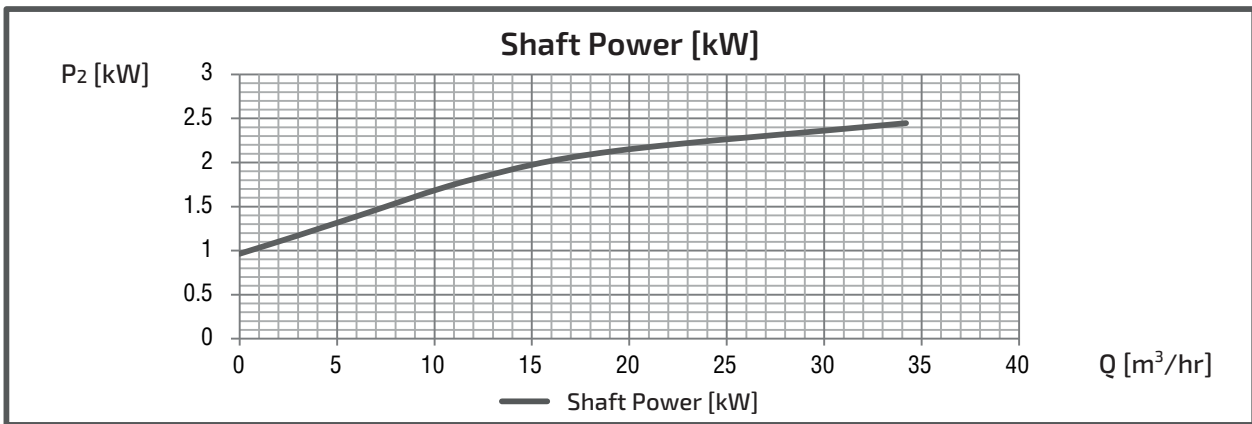
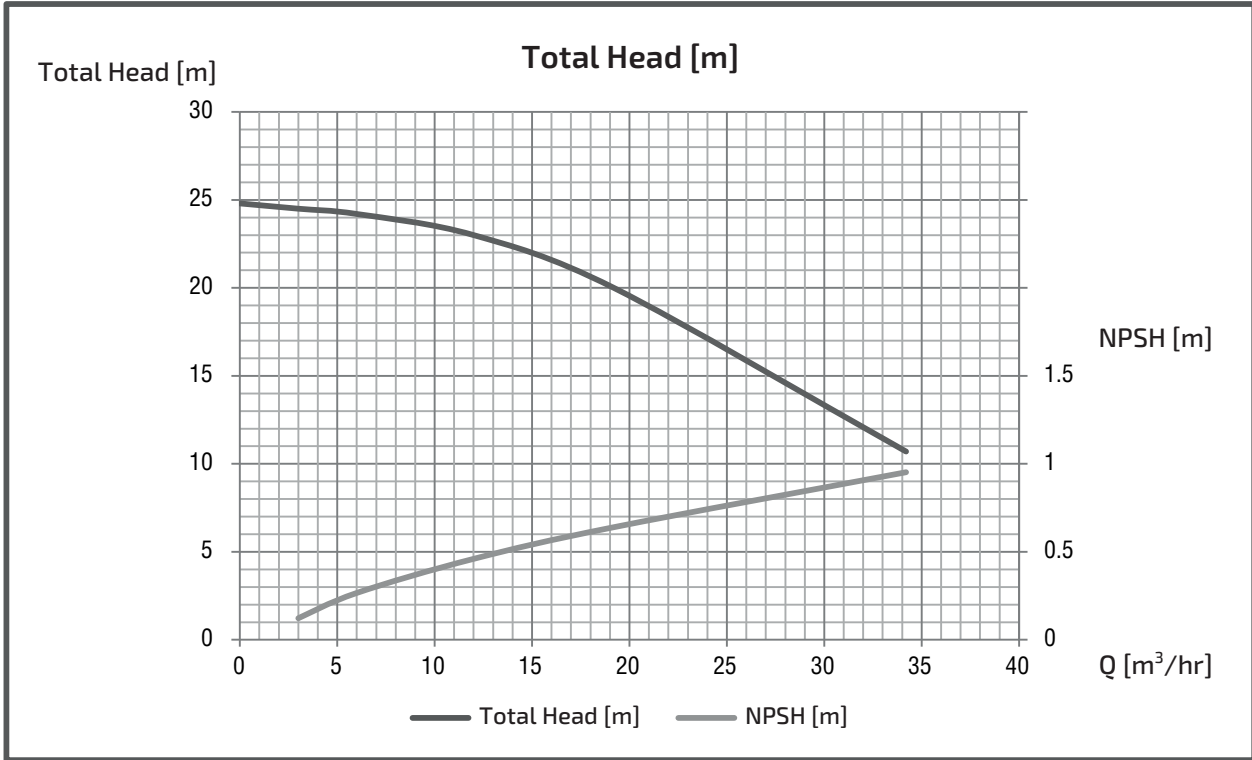

EXPECTED PERFORMANCE CURVE (GES-4M)

MODEL : GES655M4ME1.5

■ PERFORMANCE CURVES

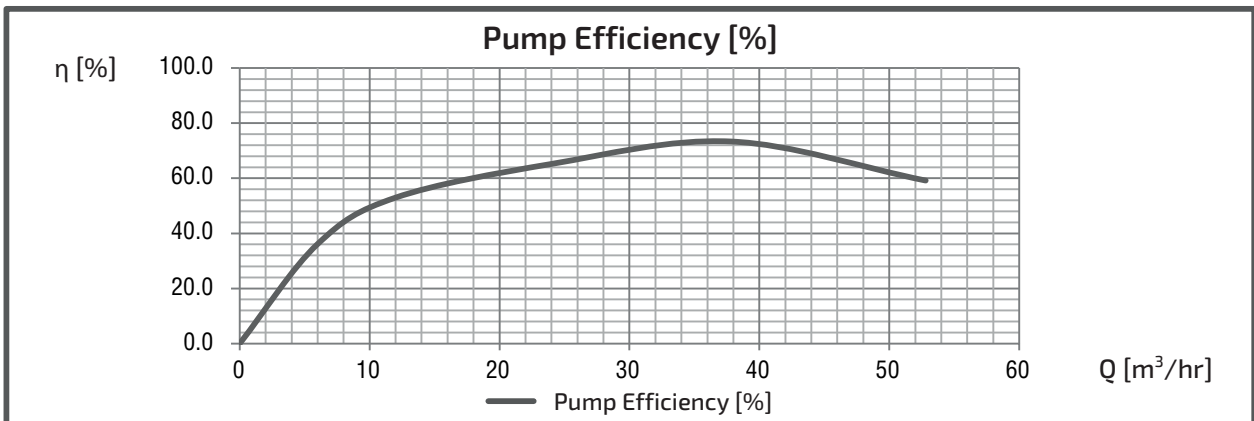
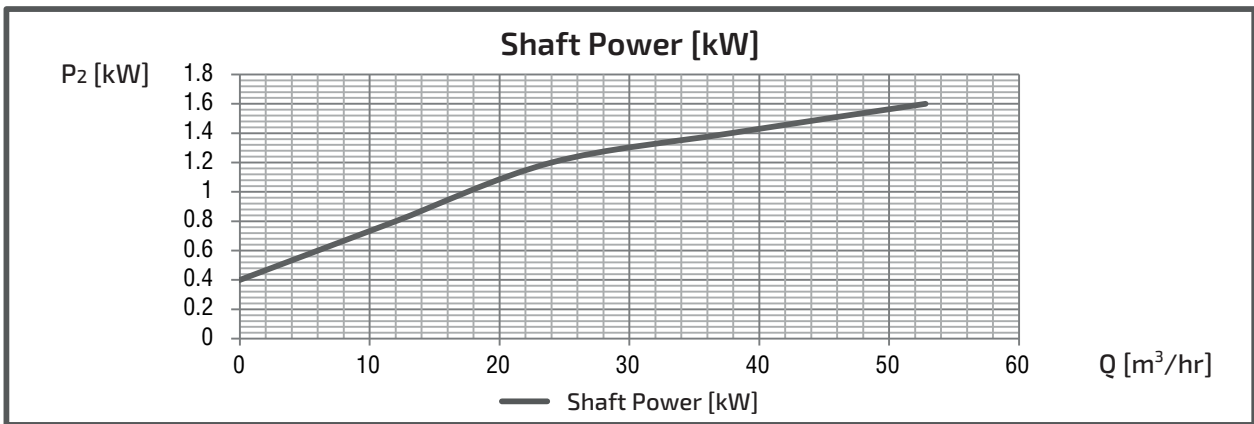
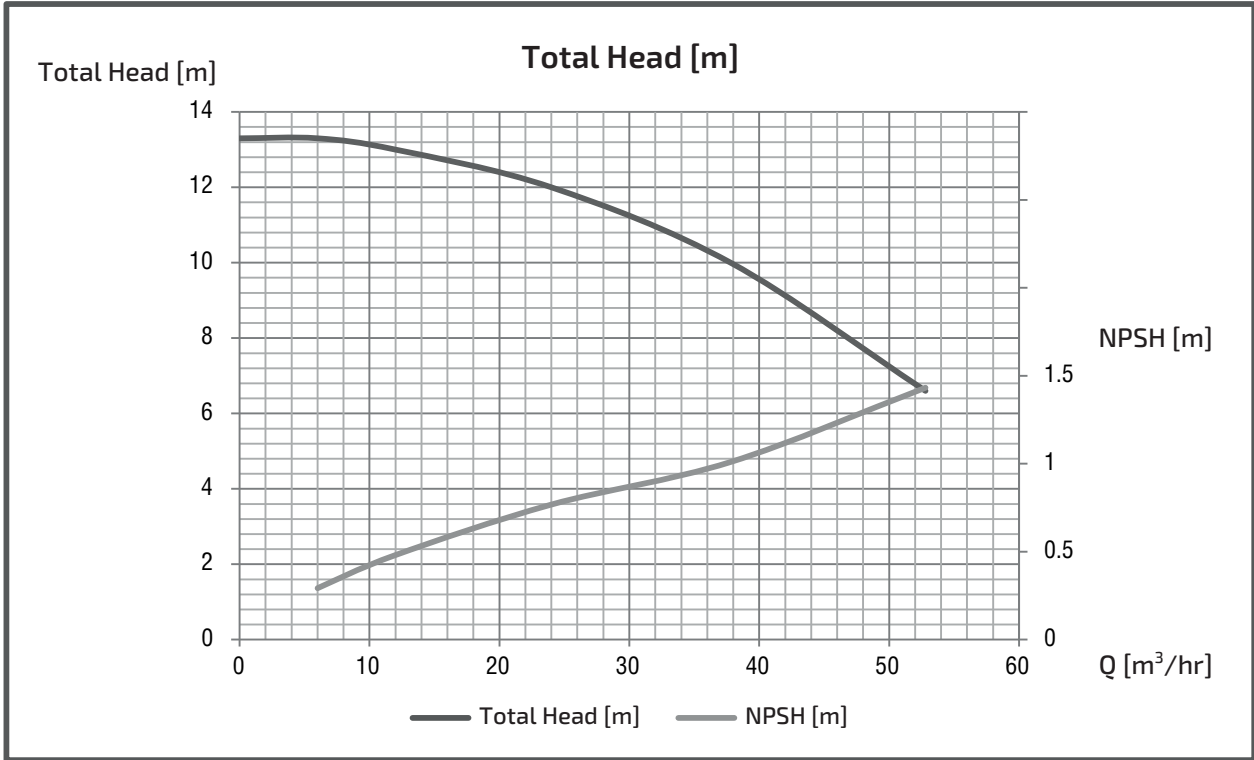

EXPECTED PERFORMANCE CURVE (GES-4M)

MODEL : GES655M4ME2.2

■ PERFORMANCE CURVES

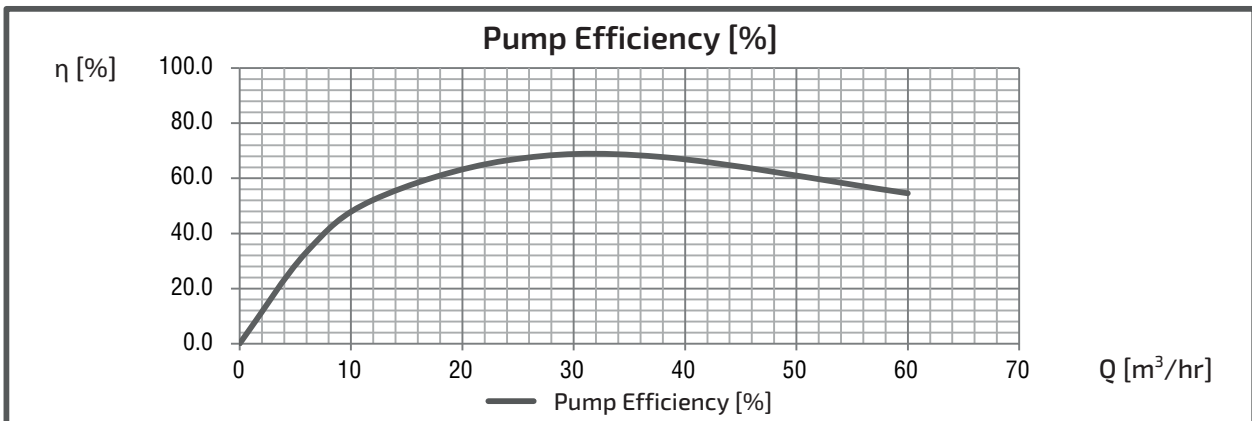
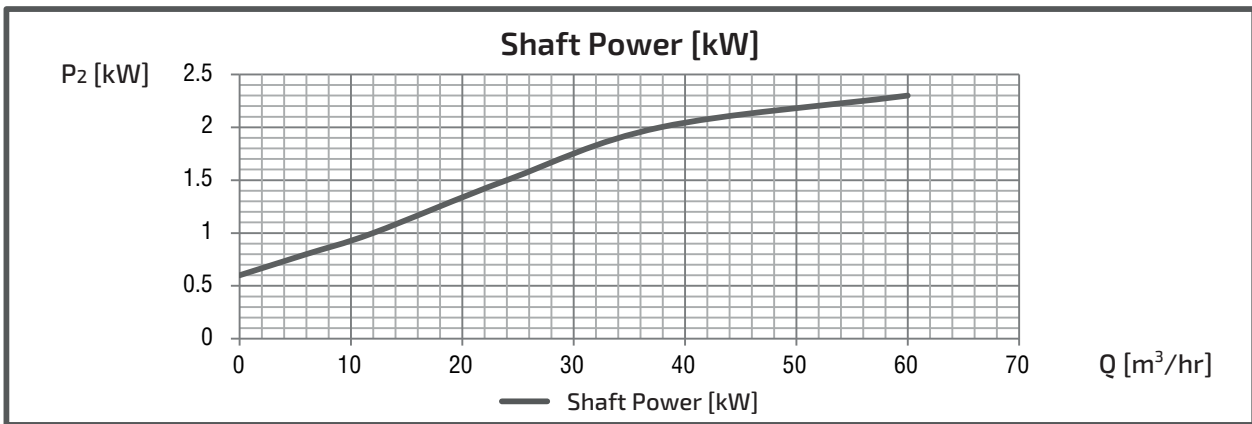
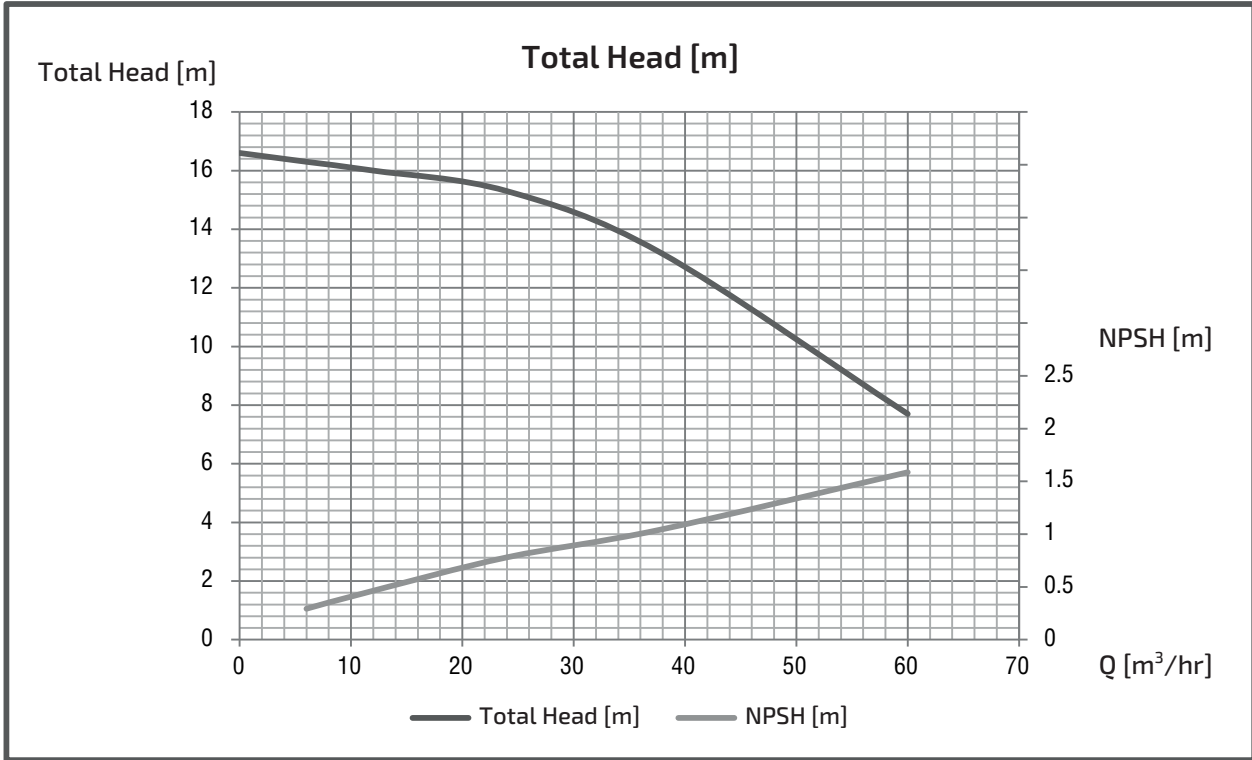

EXPECTED PERFORMANCE CURVE (GES-4M)

MODEL : GES655M4ME3.7

■ PERFORMANCE CURVES

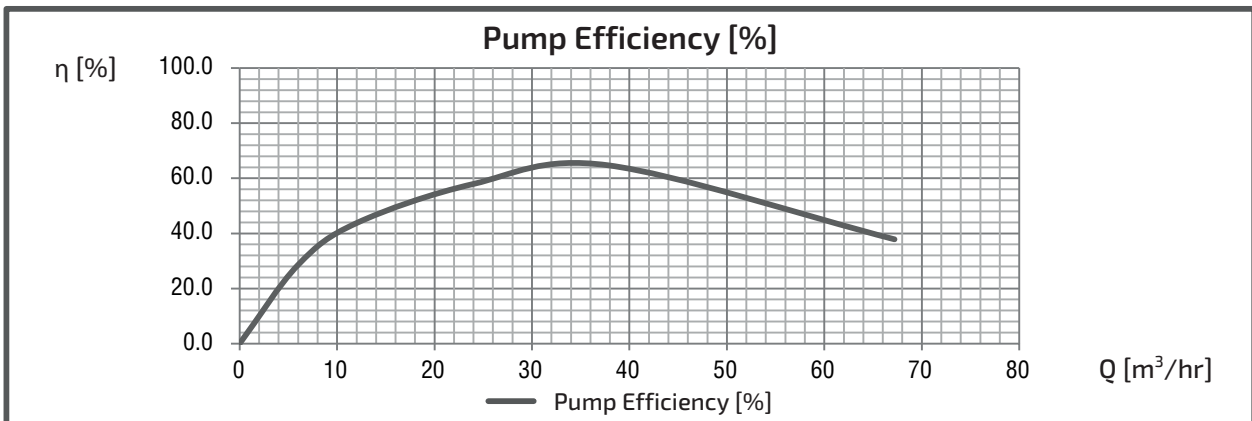
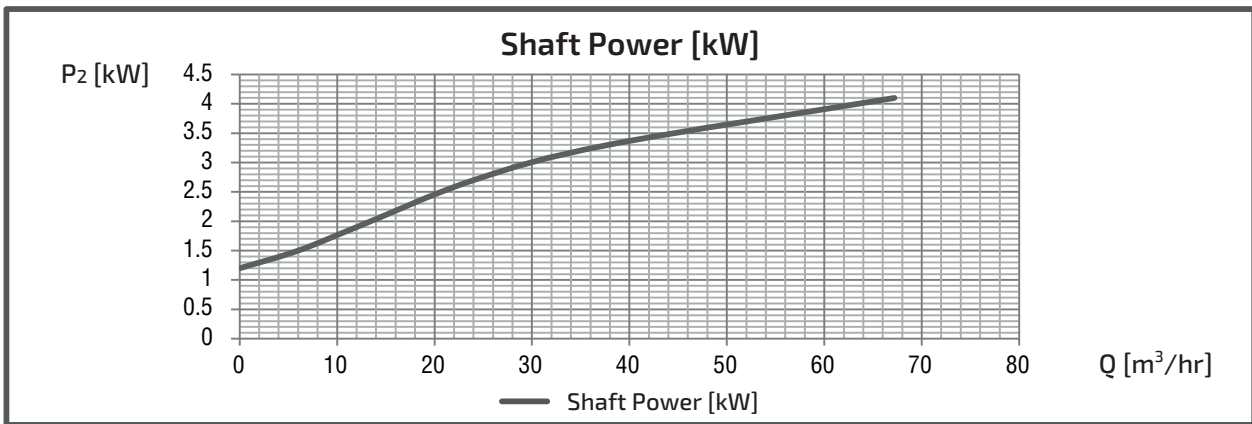
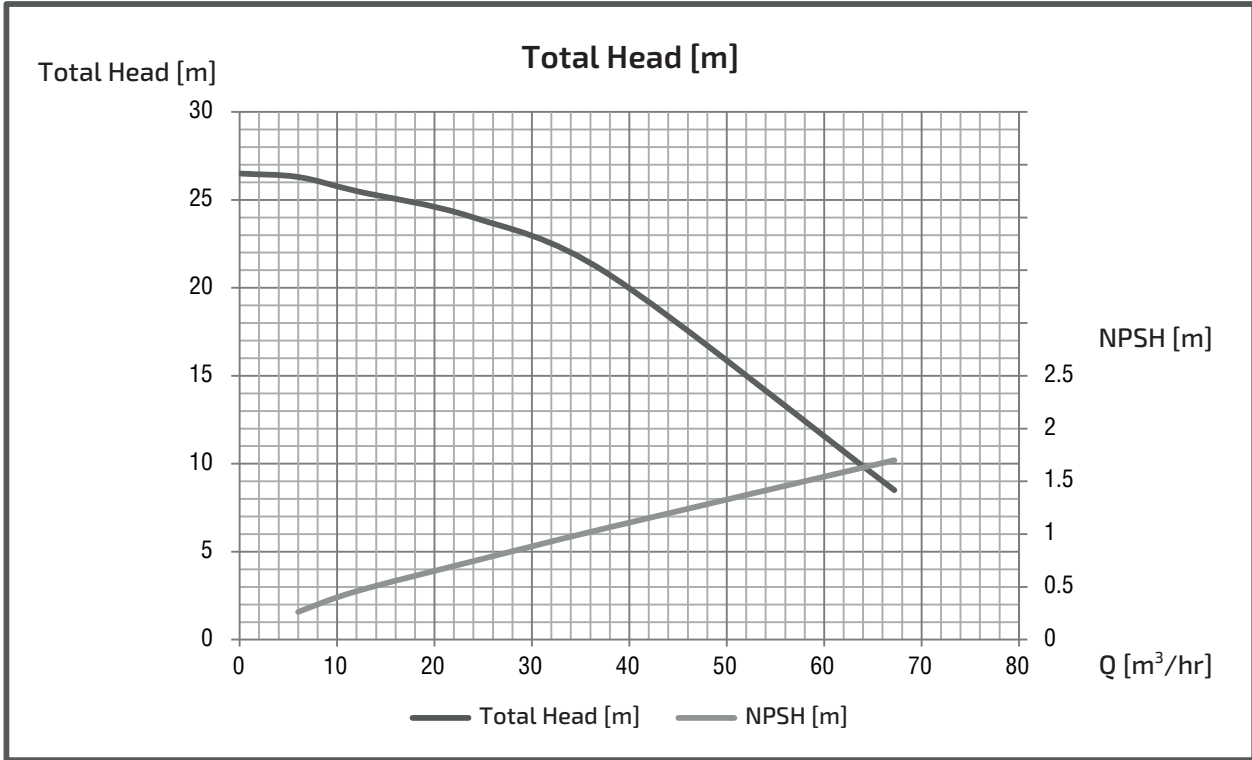

EXPECTED PERFORMANCE CURVE (GES-4M)

MODEL : GES805M4ME2.2

■ PERFORMANCE CURVES

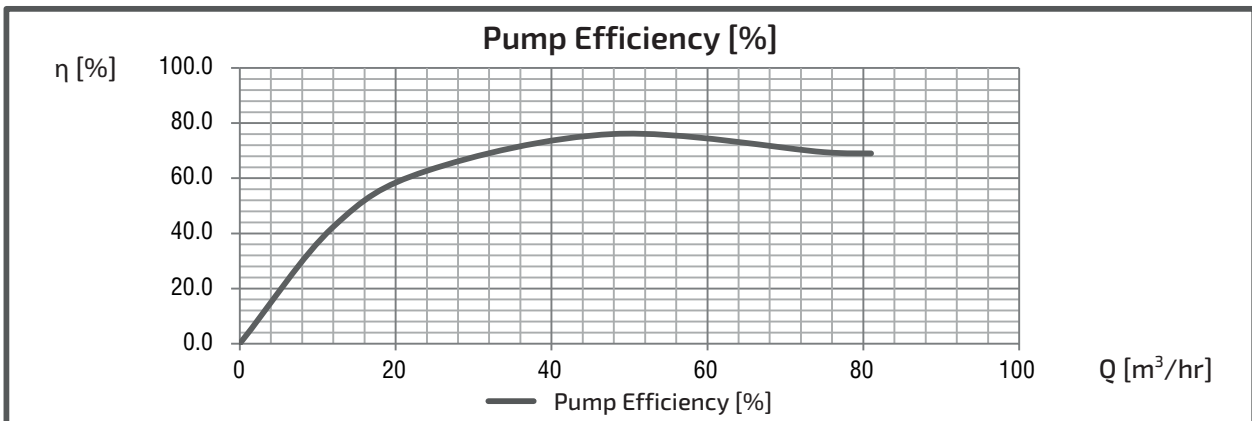
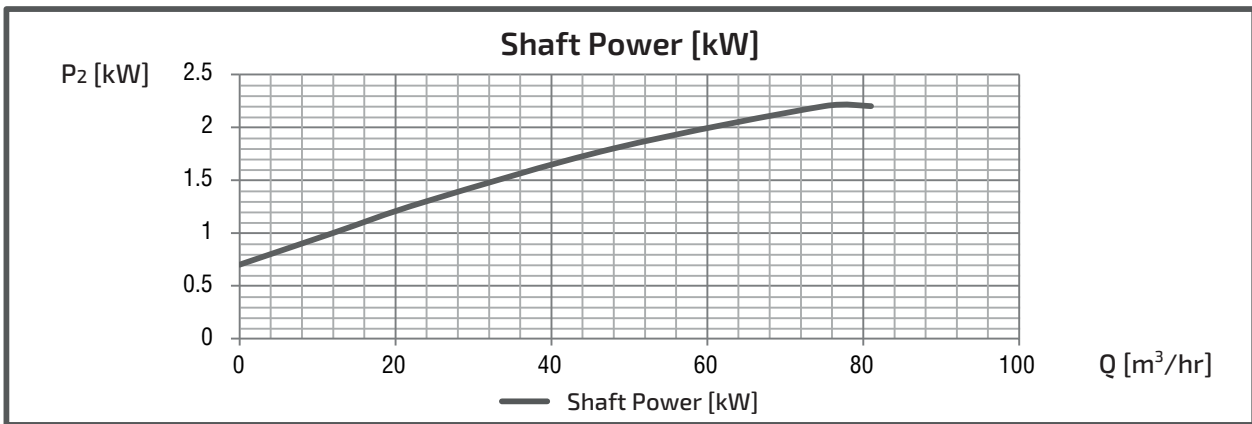
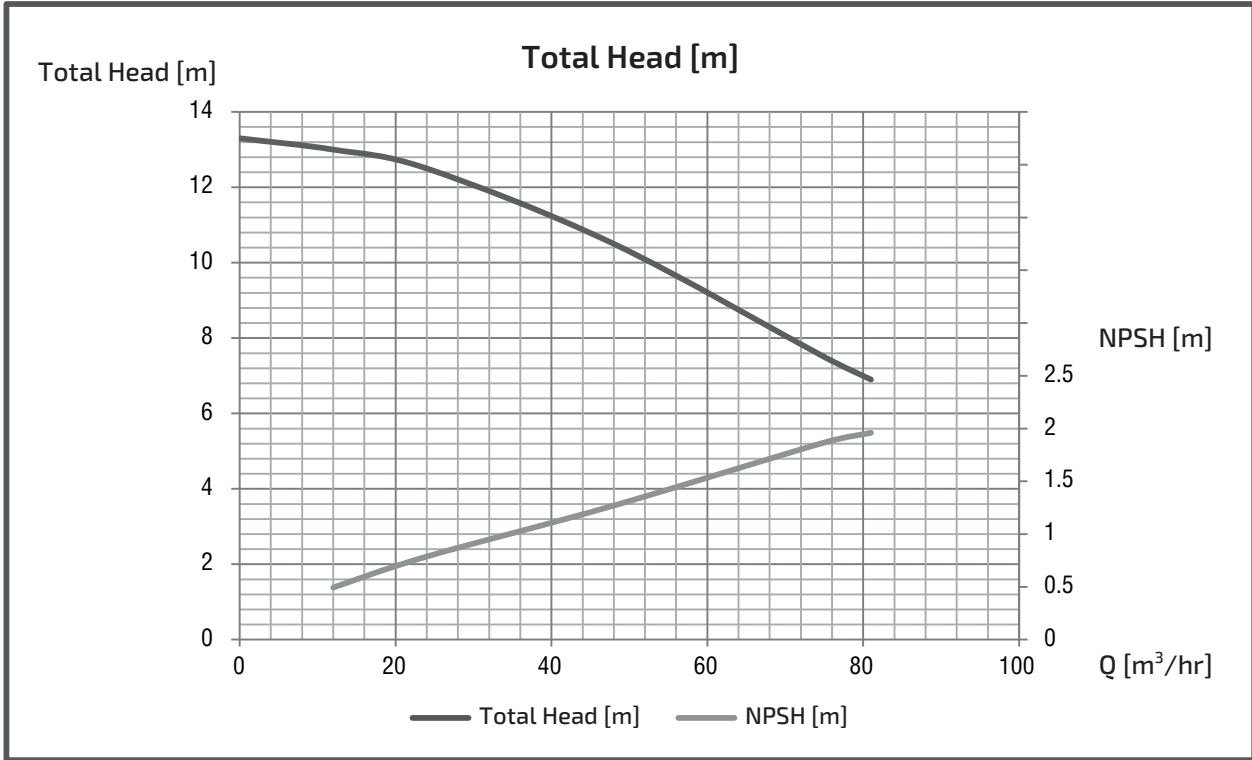

EXPECTED PERFORMANCE CURVE (GES-4M)

MODEL : GES805M4ME3.7

■ PERFORMANCE CURVES

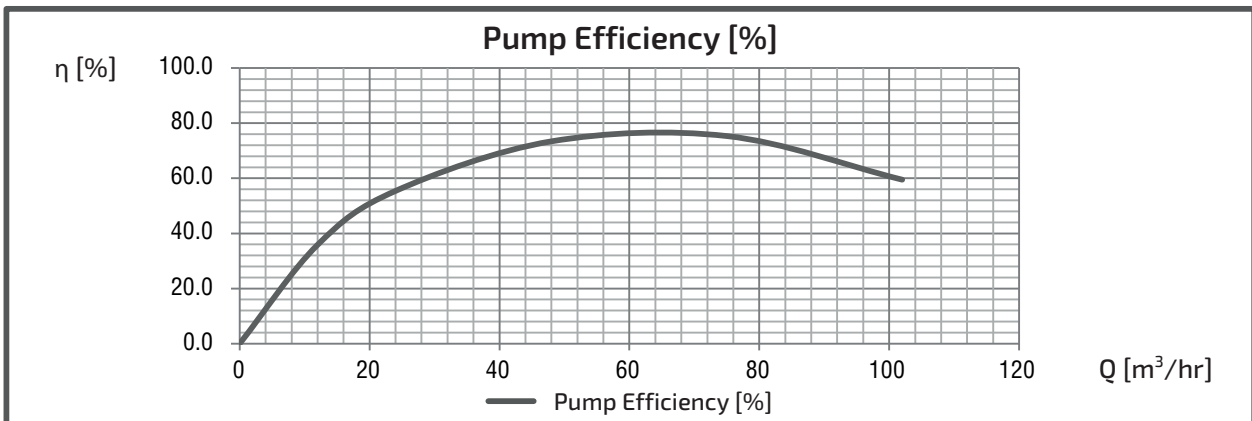
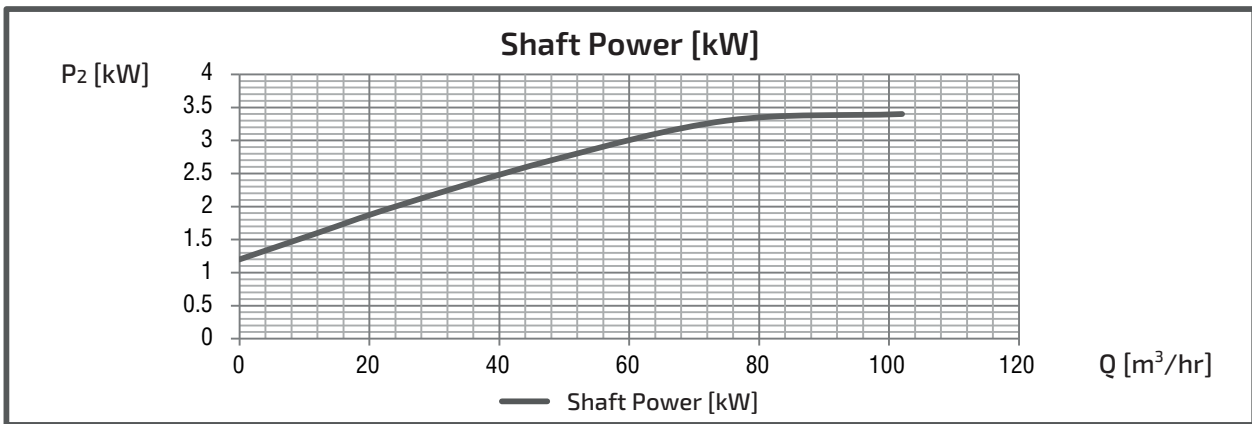
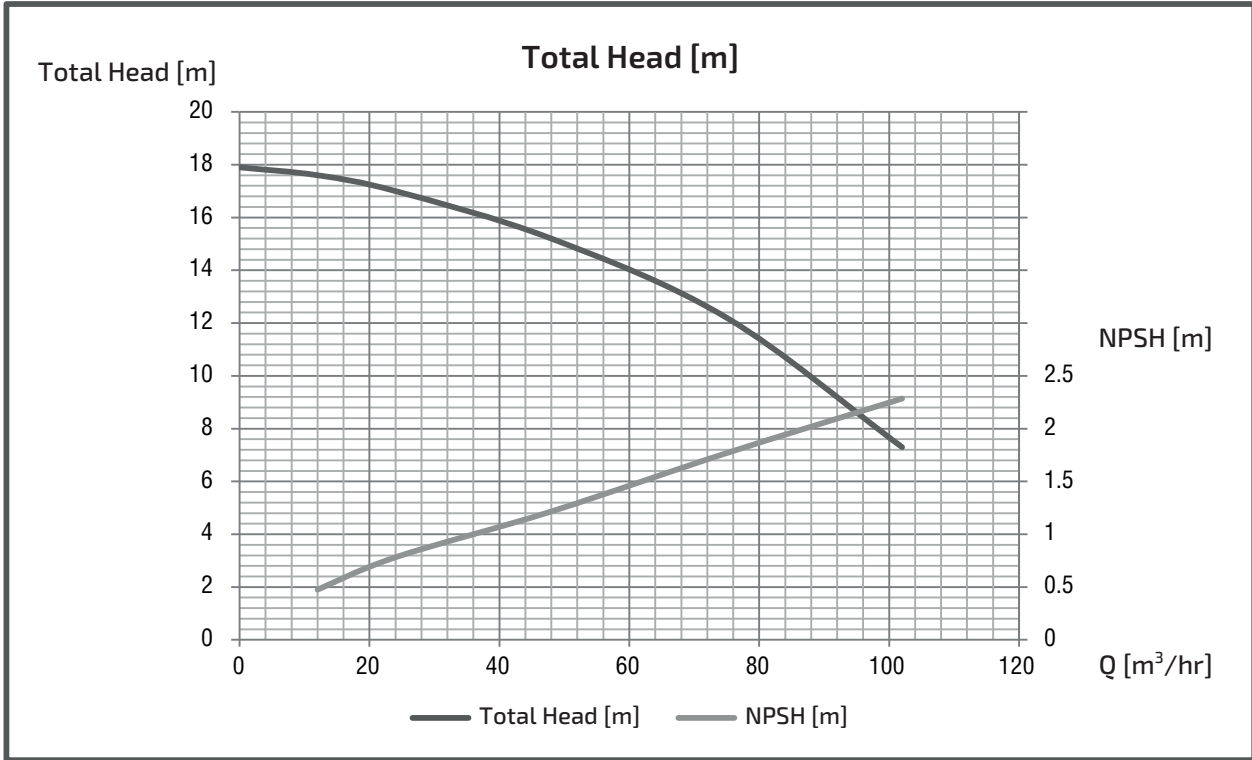

EXPECTED PERFORMANCE CURVE (GES-4M)

MODEL : GES805M4ME5.5

■ PERFORMANCE CURVES

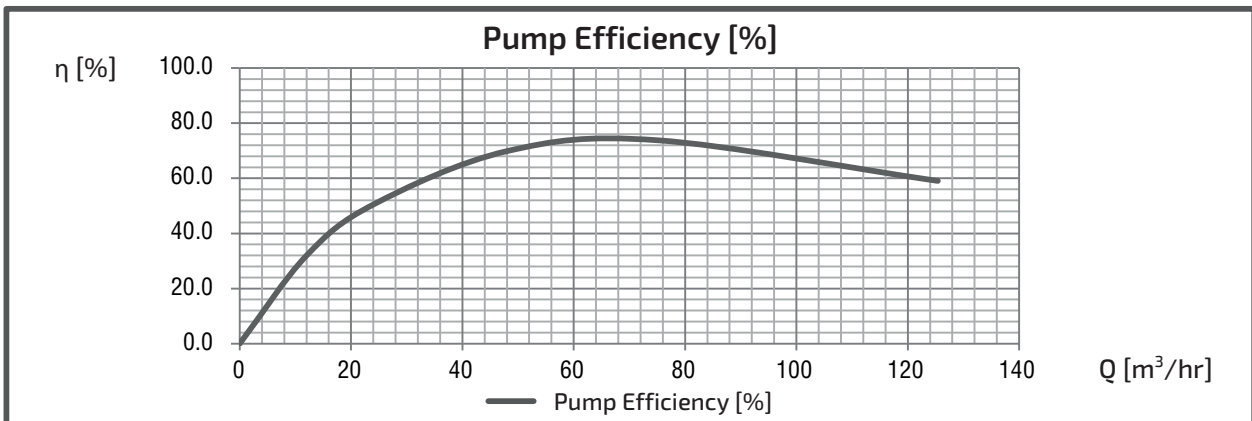
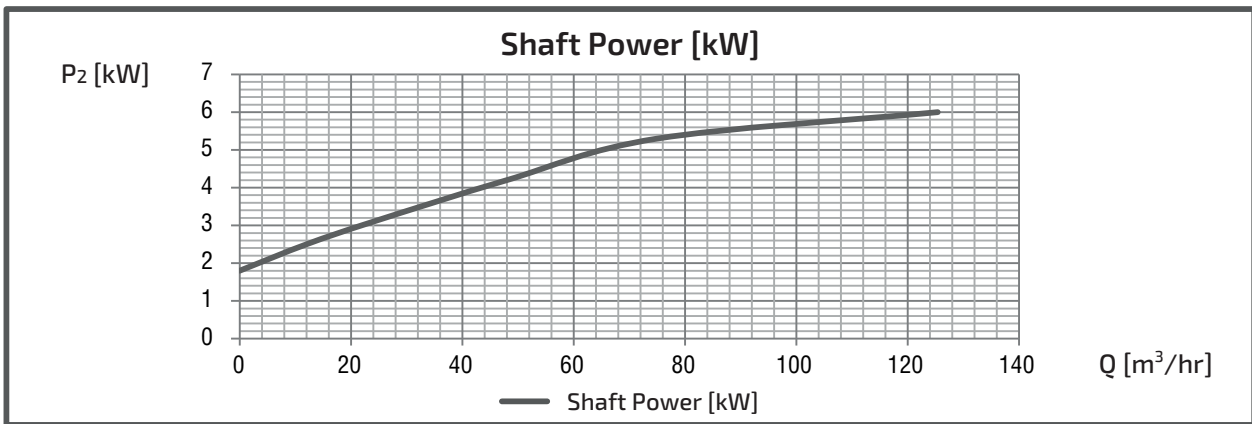
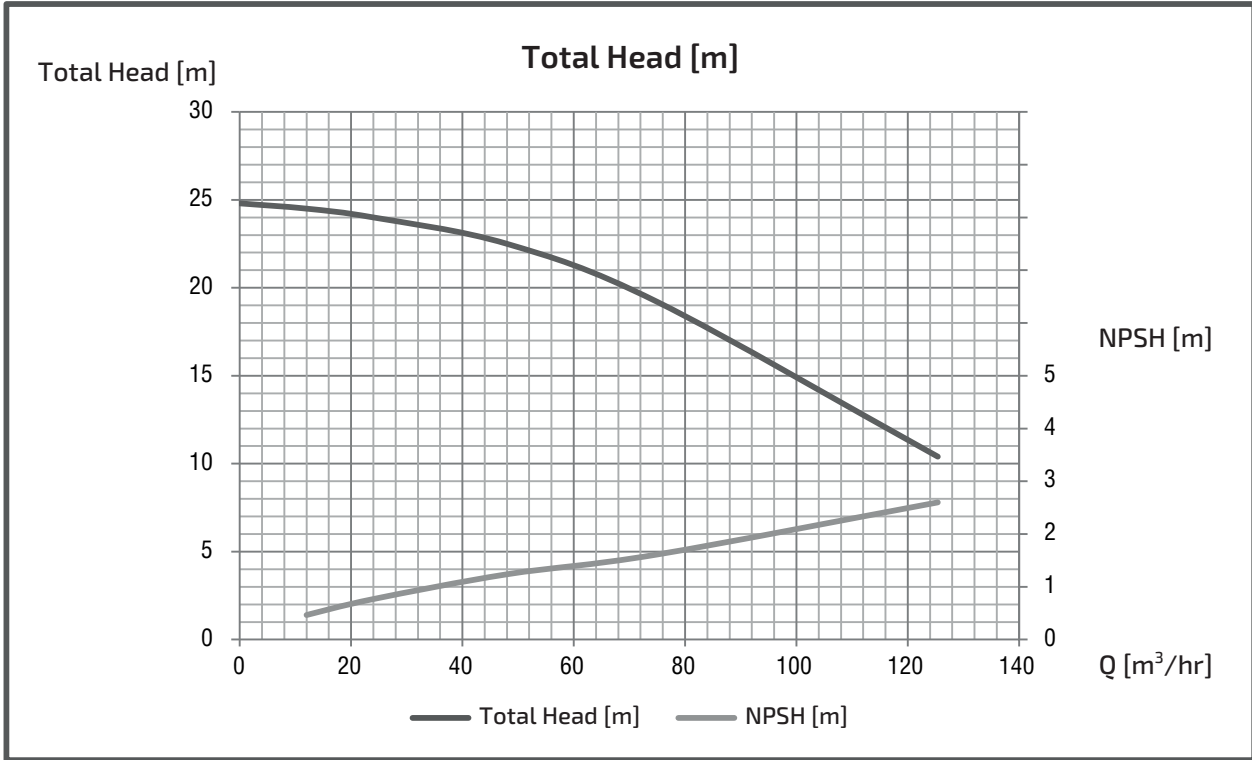

EXPECTED PERFORMANCE CURVE (GES-4M)

MODEL : GES805M4ME7.5

■ PERFORMANCE CURVES

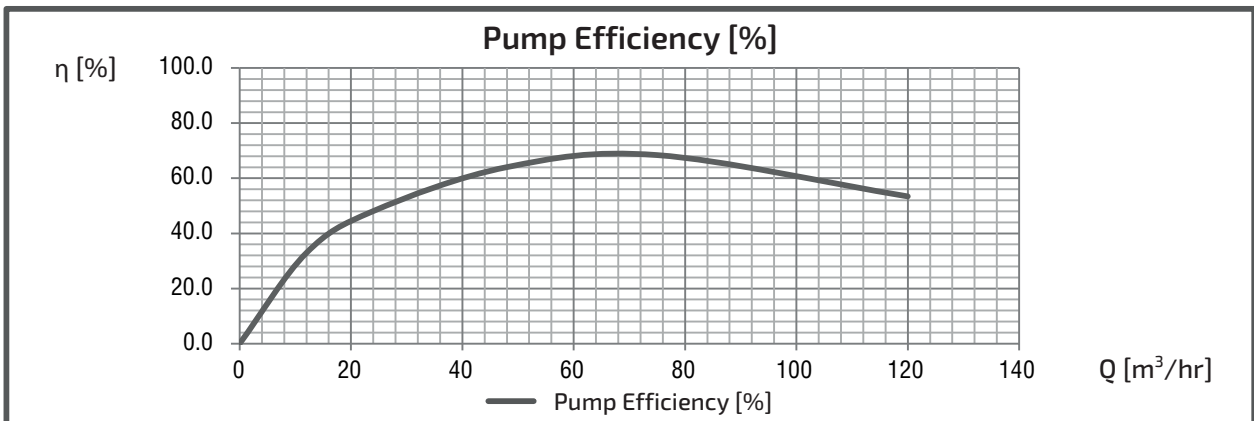
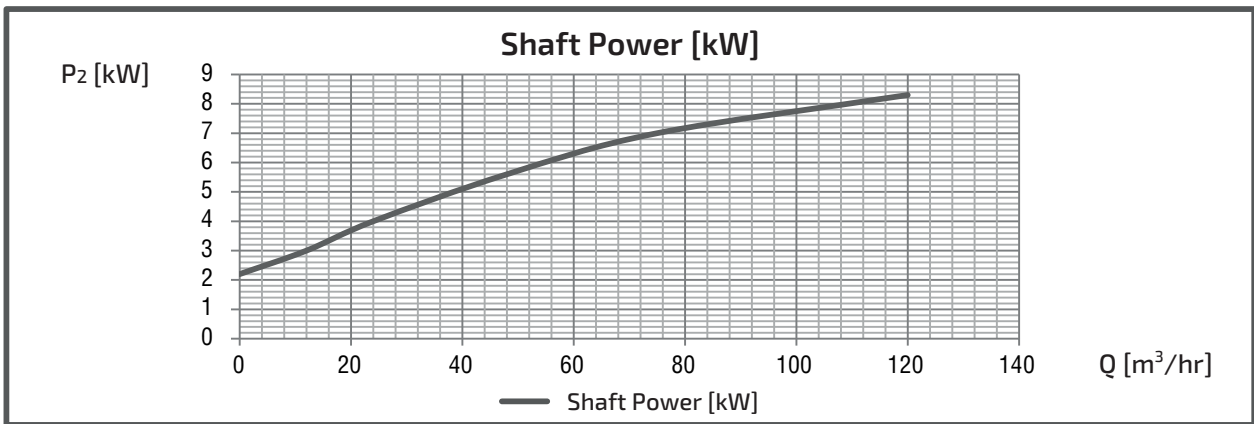
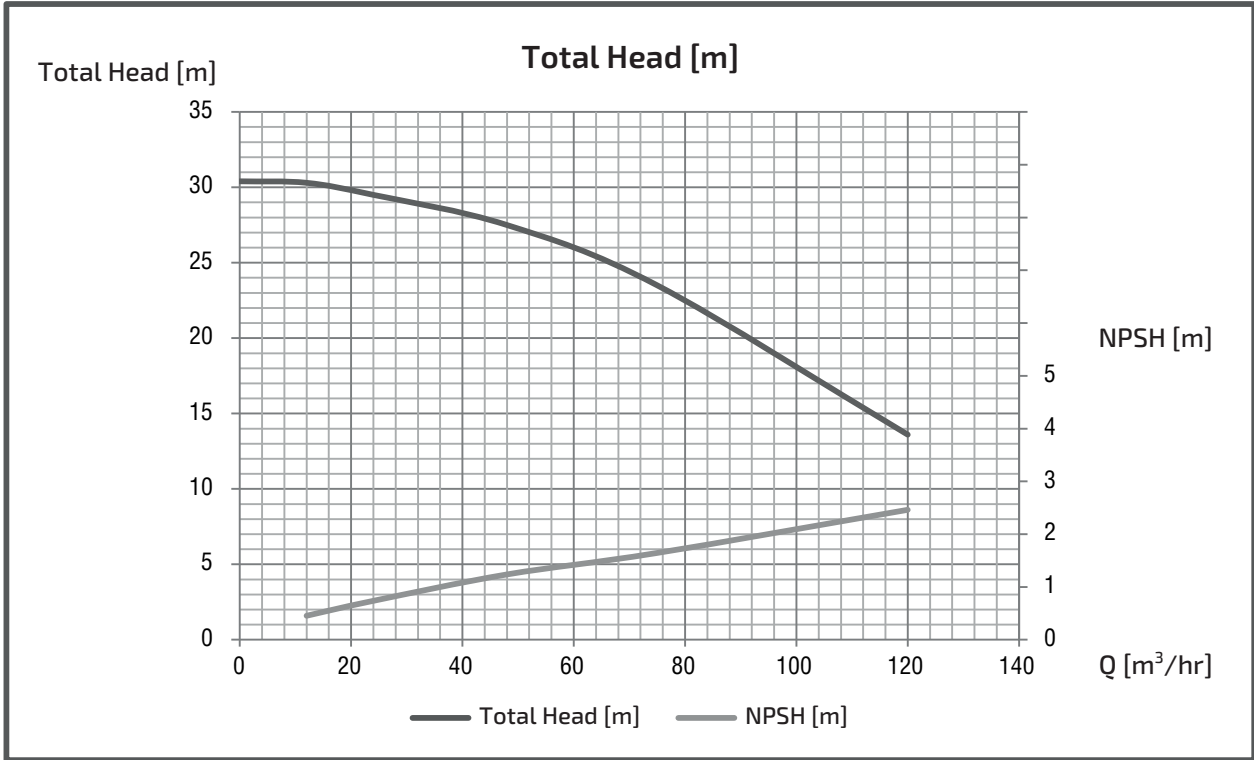

EXPECTED PERFORMANCE CURVE (GES-4M)

MODEL : GES1005M4ME3.7

■ PERFORMANCE CURVES

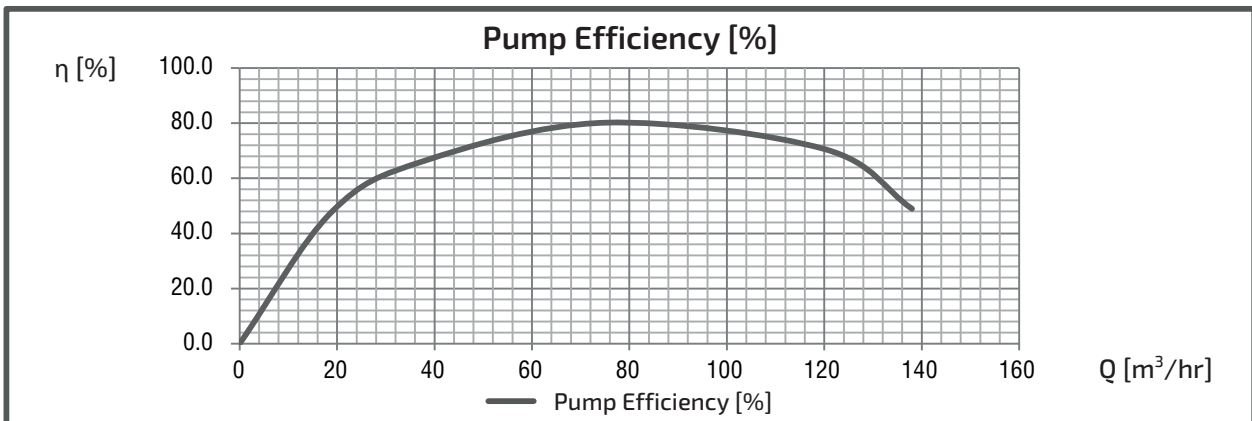
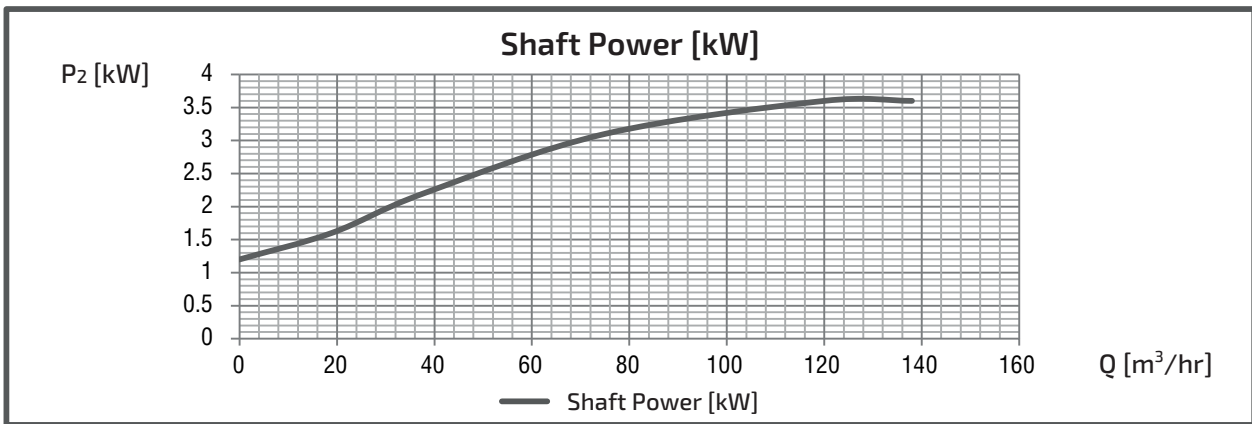
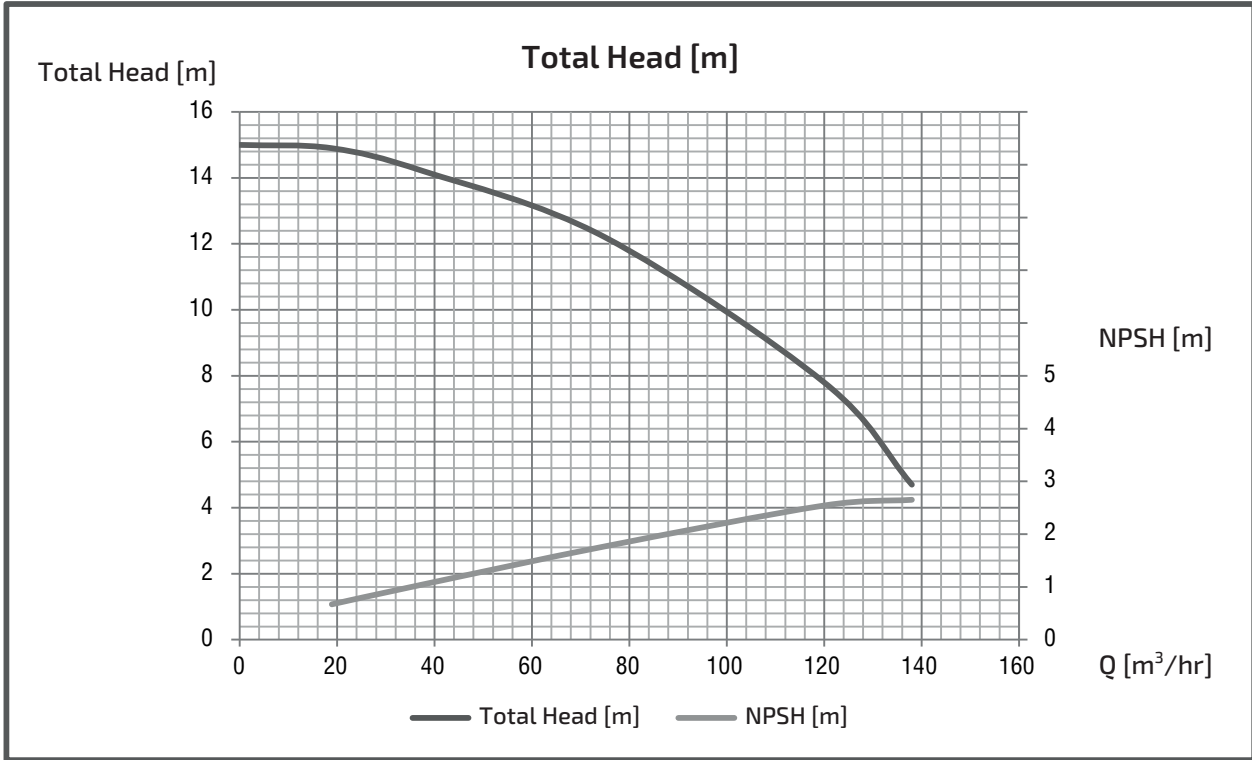

EXPECTED PERFORMANCE CURVE (GES-4M)

MODEL : GES1005M4ME5.5

■ PERFORMANCE CURVES

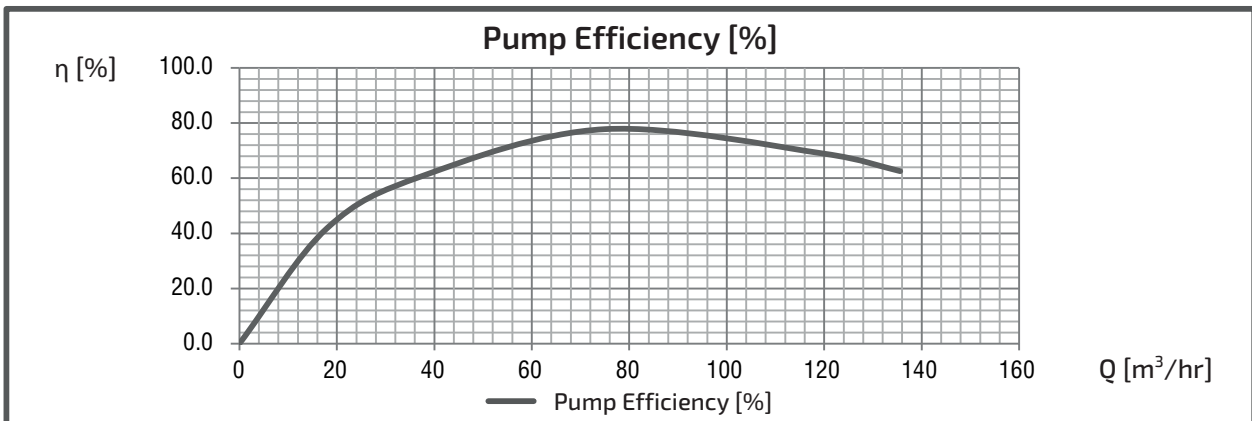
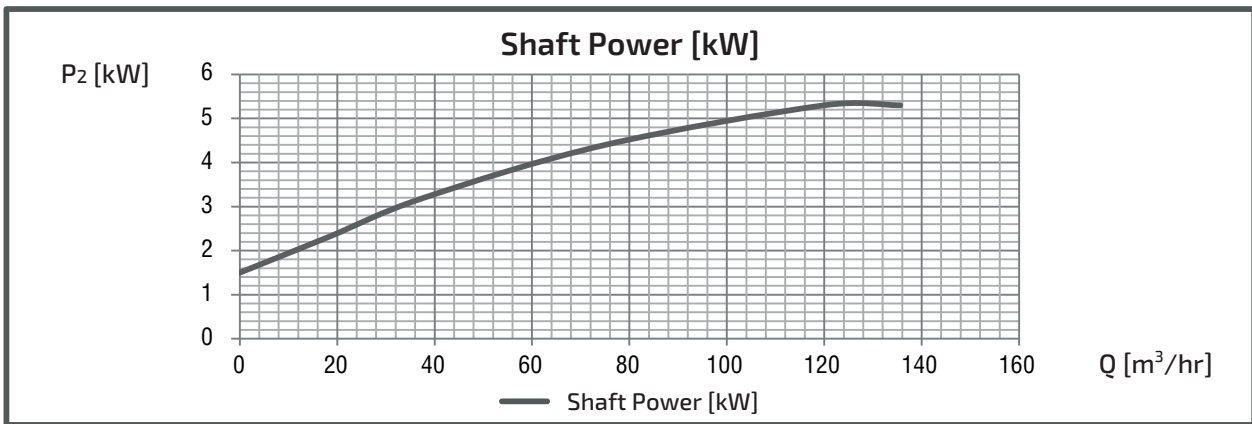
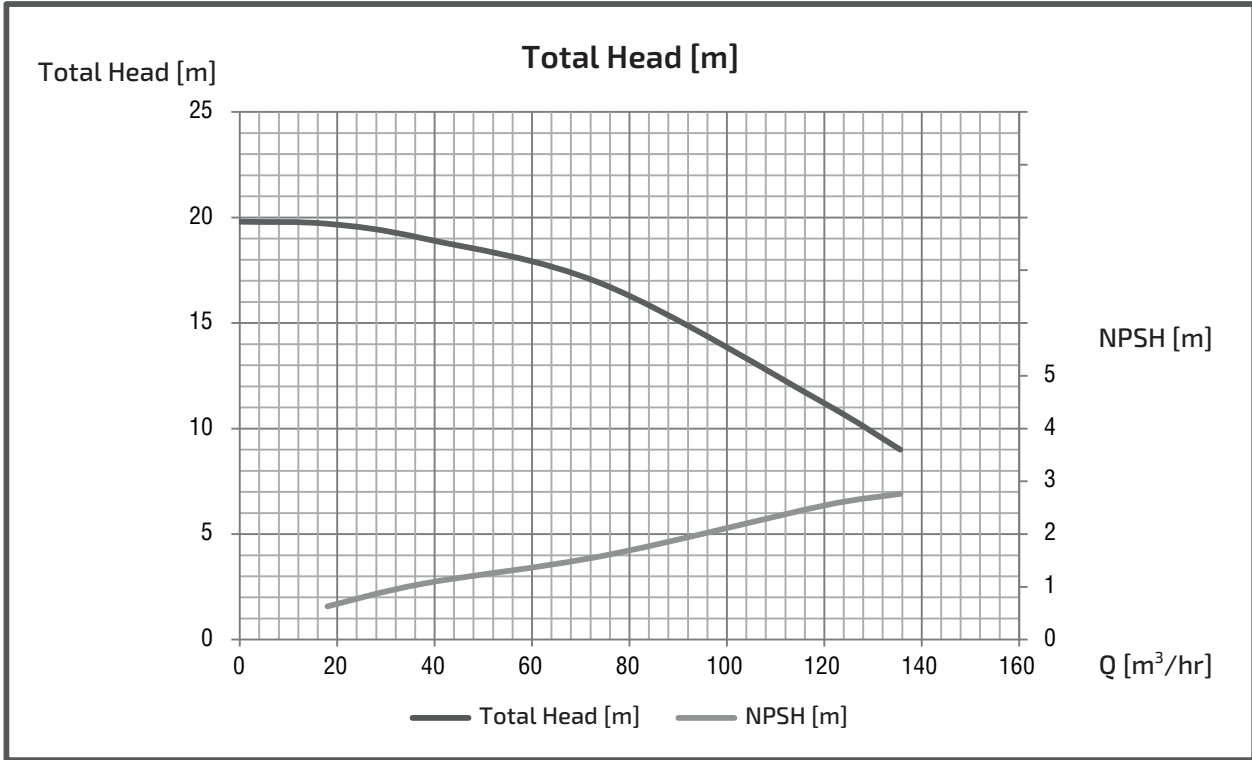

EXPECTED PERFORMANCE CURVE (GES-4M)

MODEL : GES1005M4ME7.5

■ PERFORMANCE CURVES

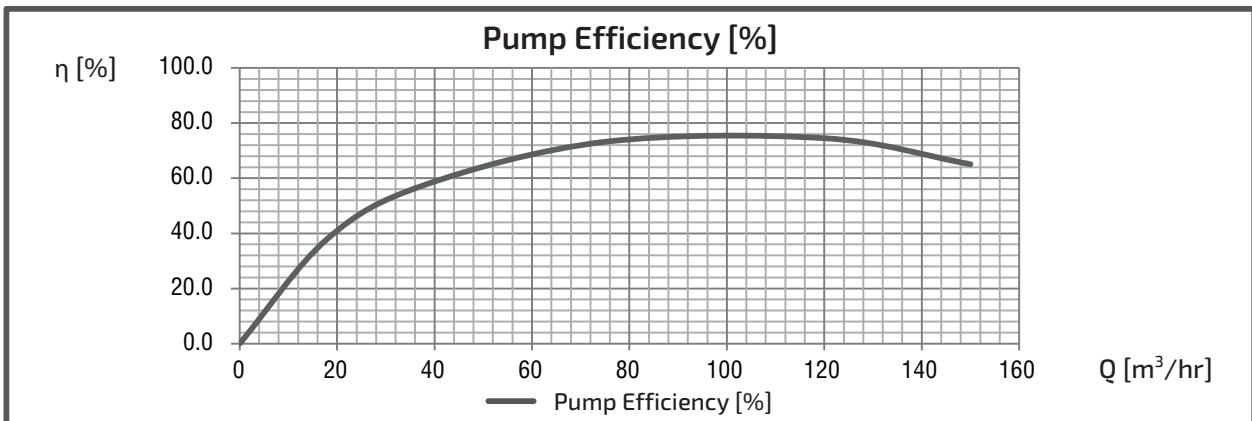
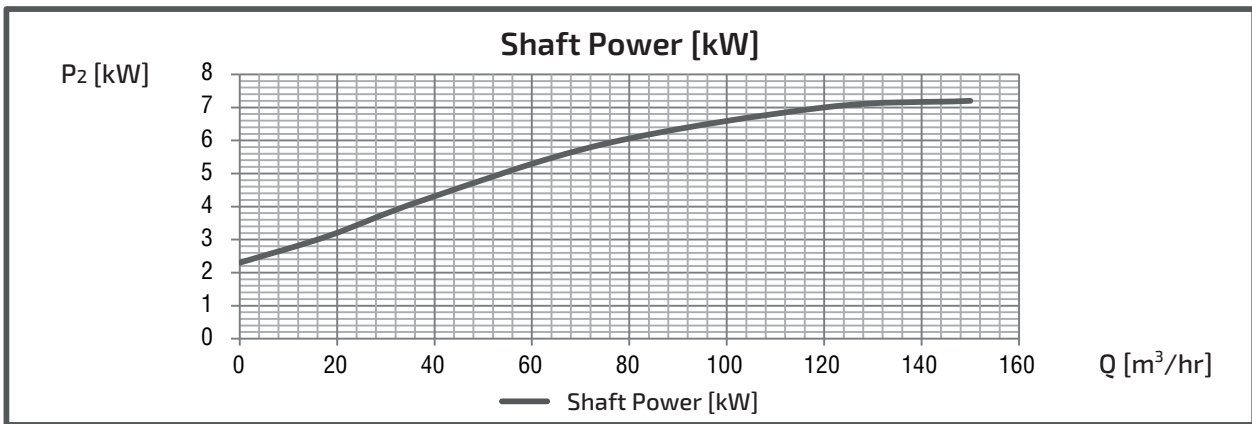
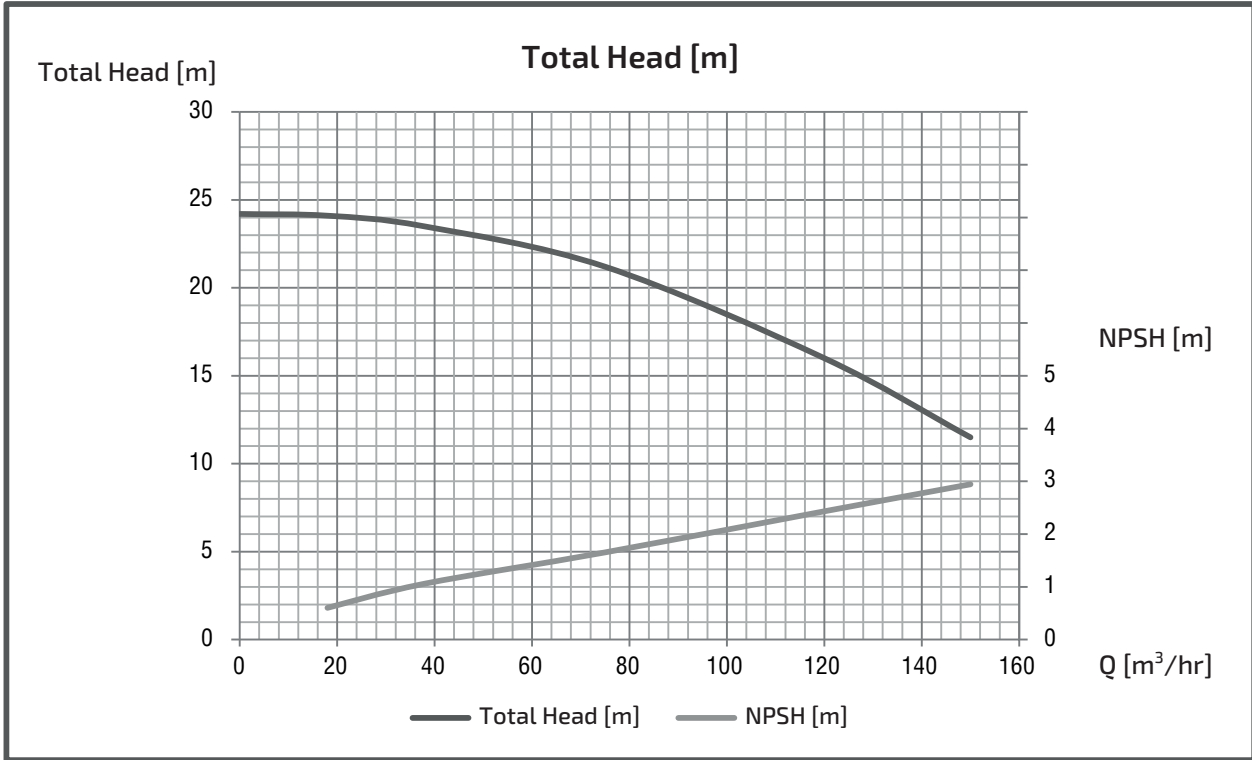

EXPECTED PERFORMANCE CURVE (GES-4M)

MODEL : GES1005M4ME11

■ PERFORMANCE CURVES

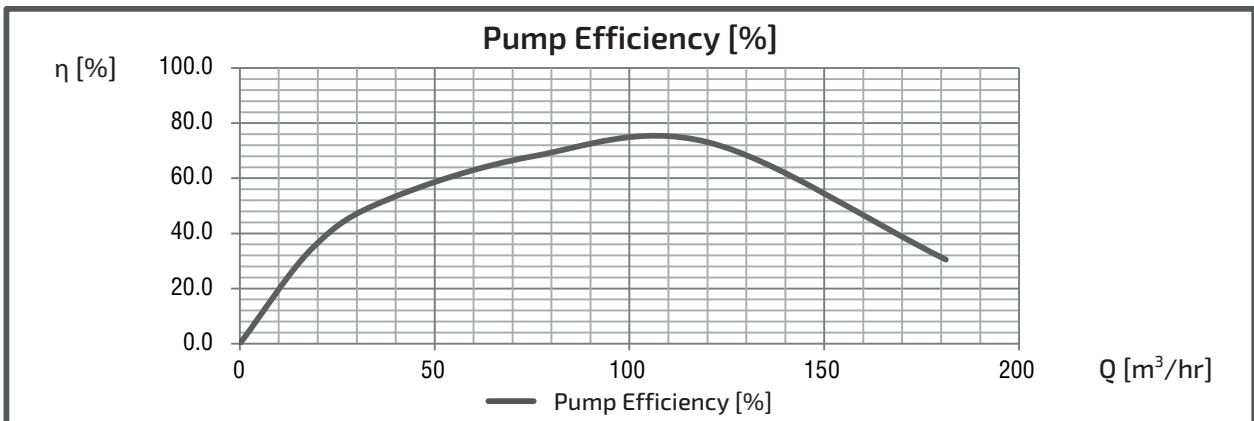
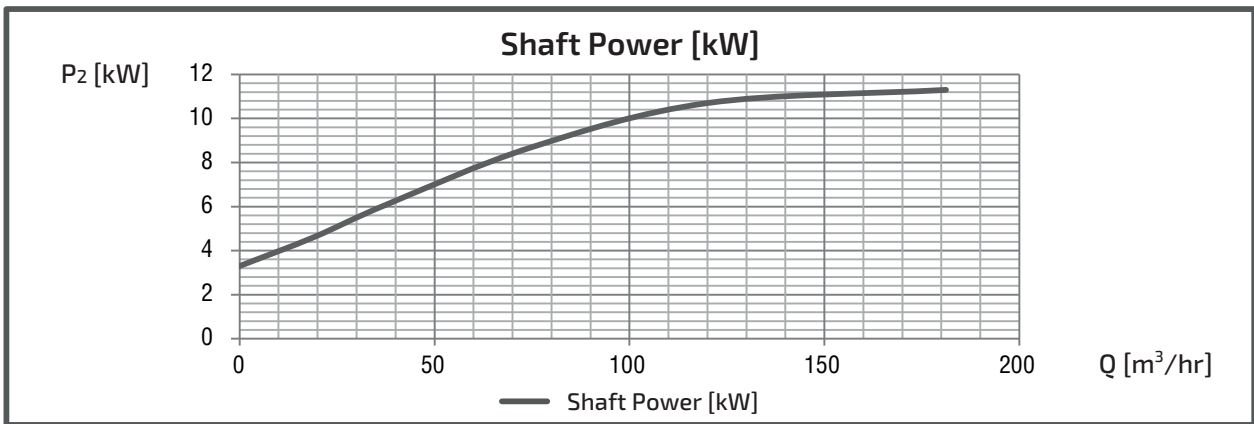
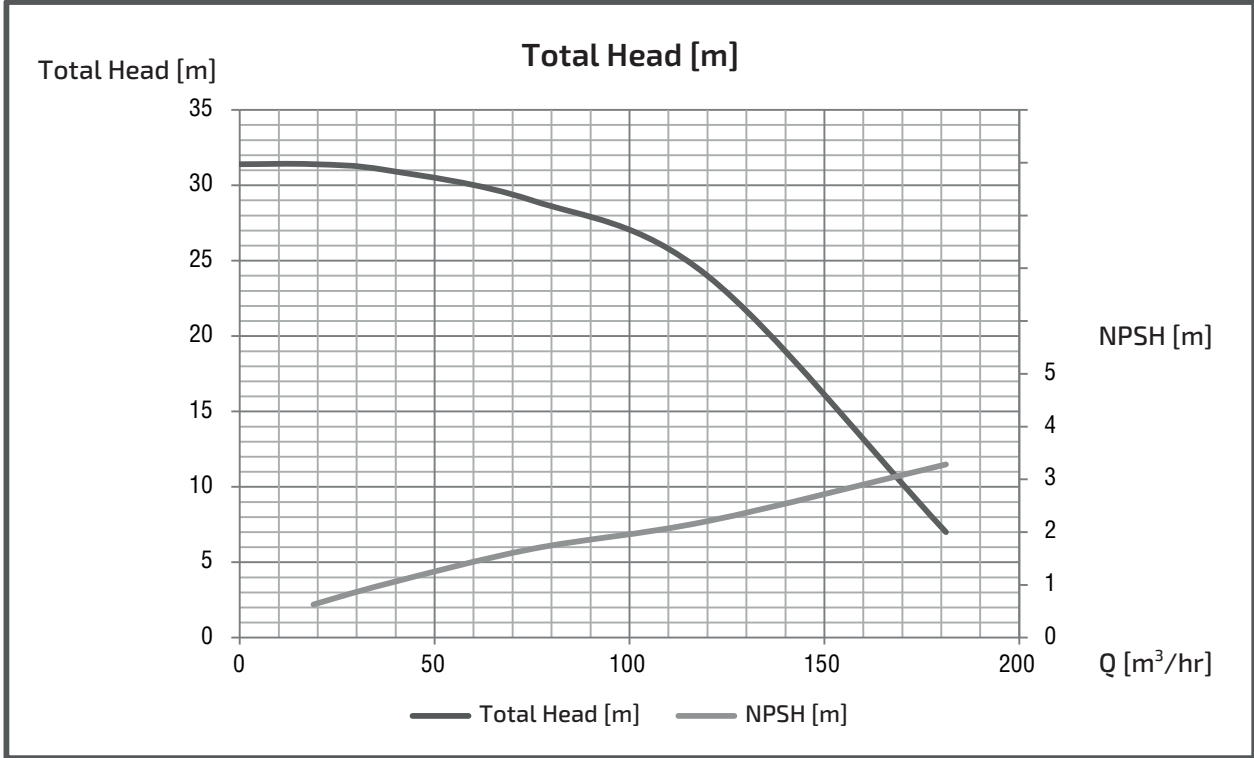

EXPECTED PERFORMANCE CURVE (GES-4M)

MODEL : GES1005M4ME15

■ PERFORMANCE CURVES

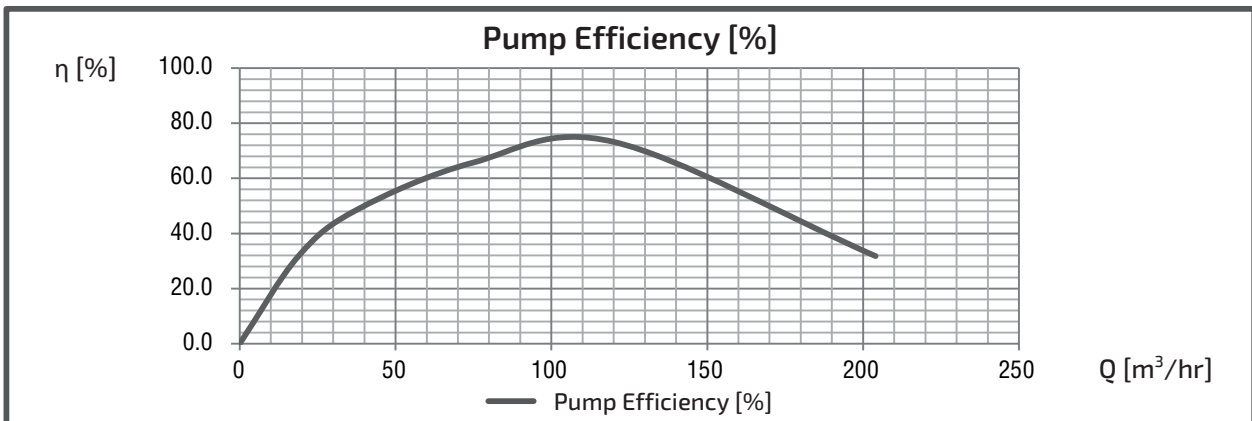
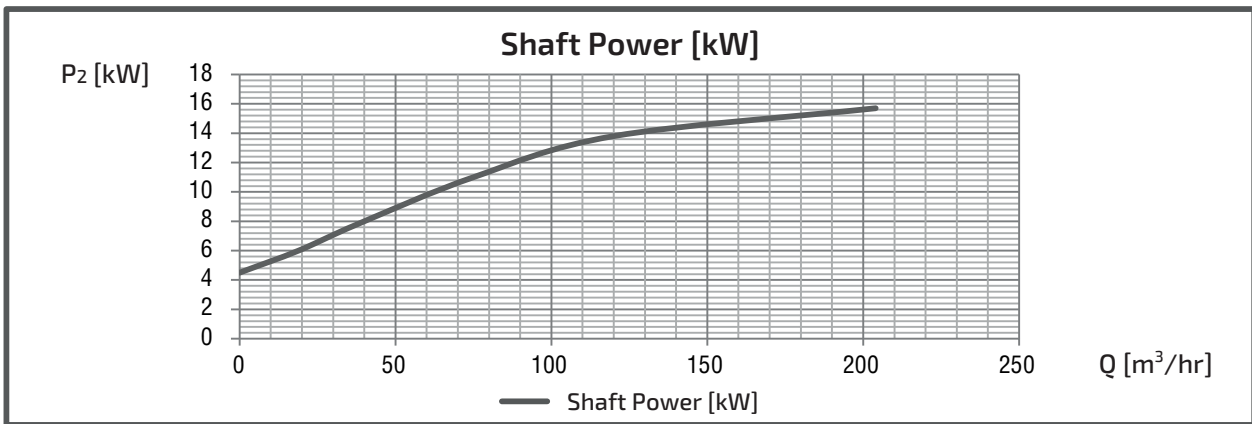
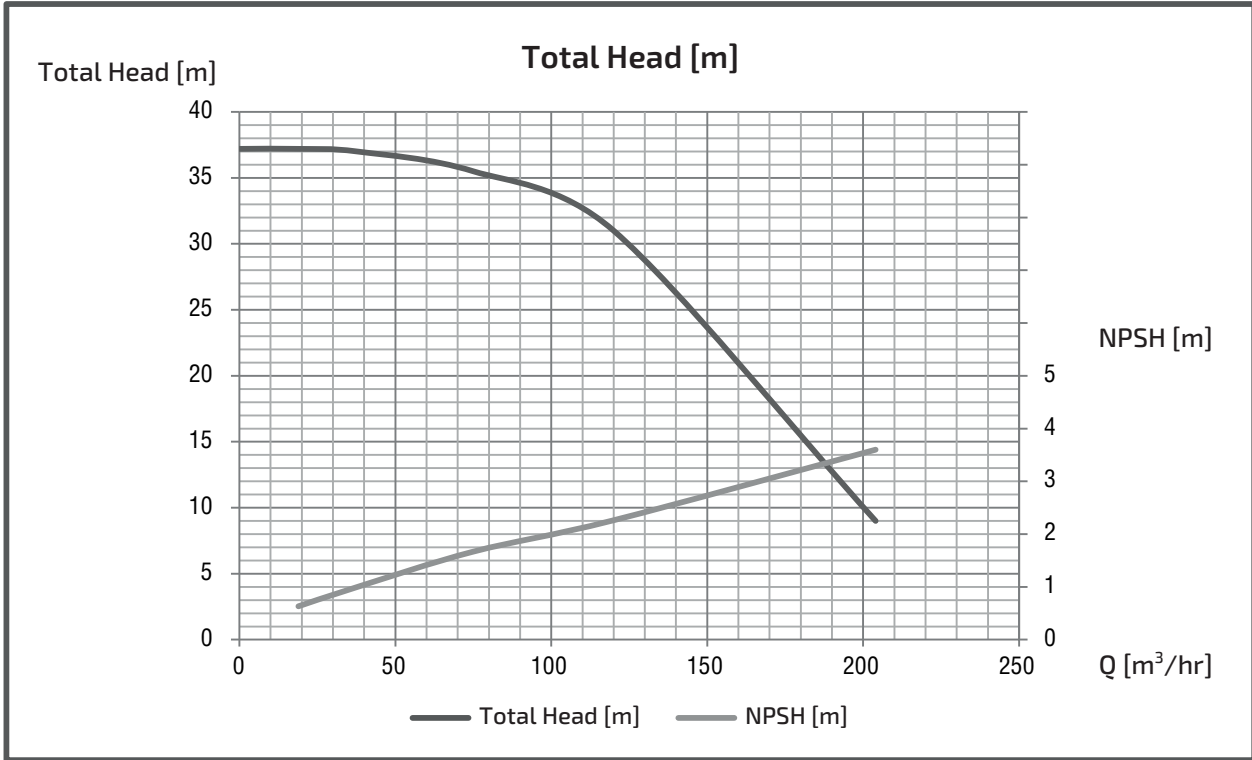

EXPECTED PERFORMANCE CURVE (GES-C)

MODEL : GES405CE0.75T4

■ PERFORMANCE CURVES

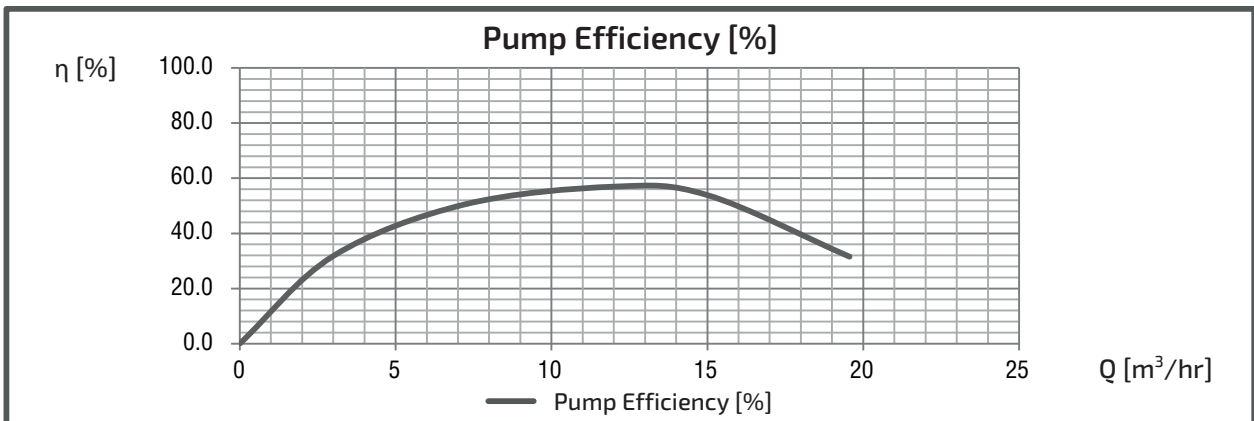
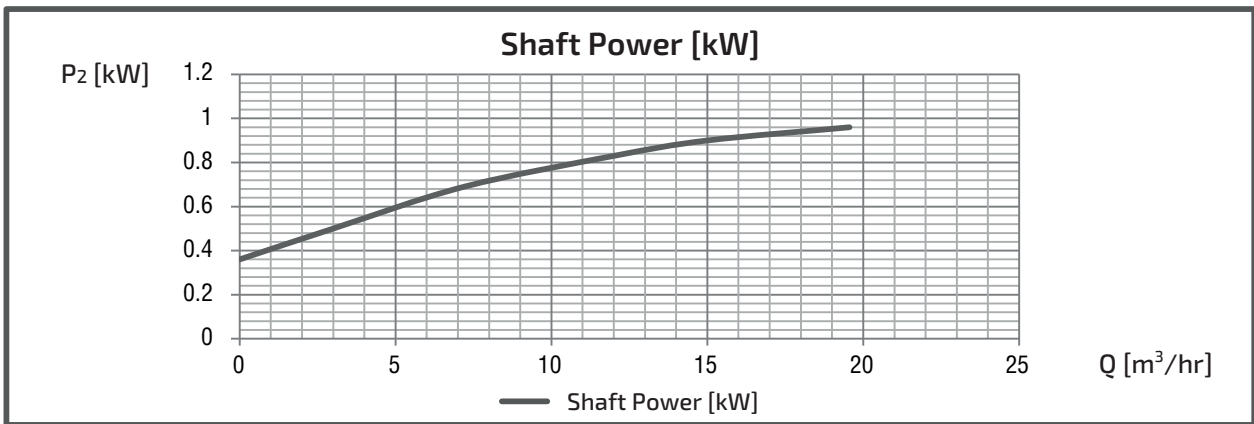
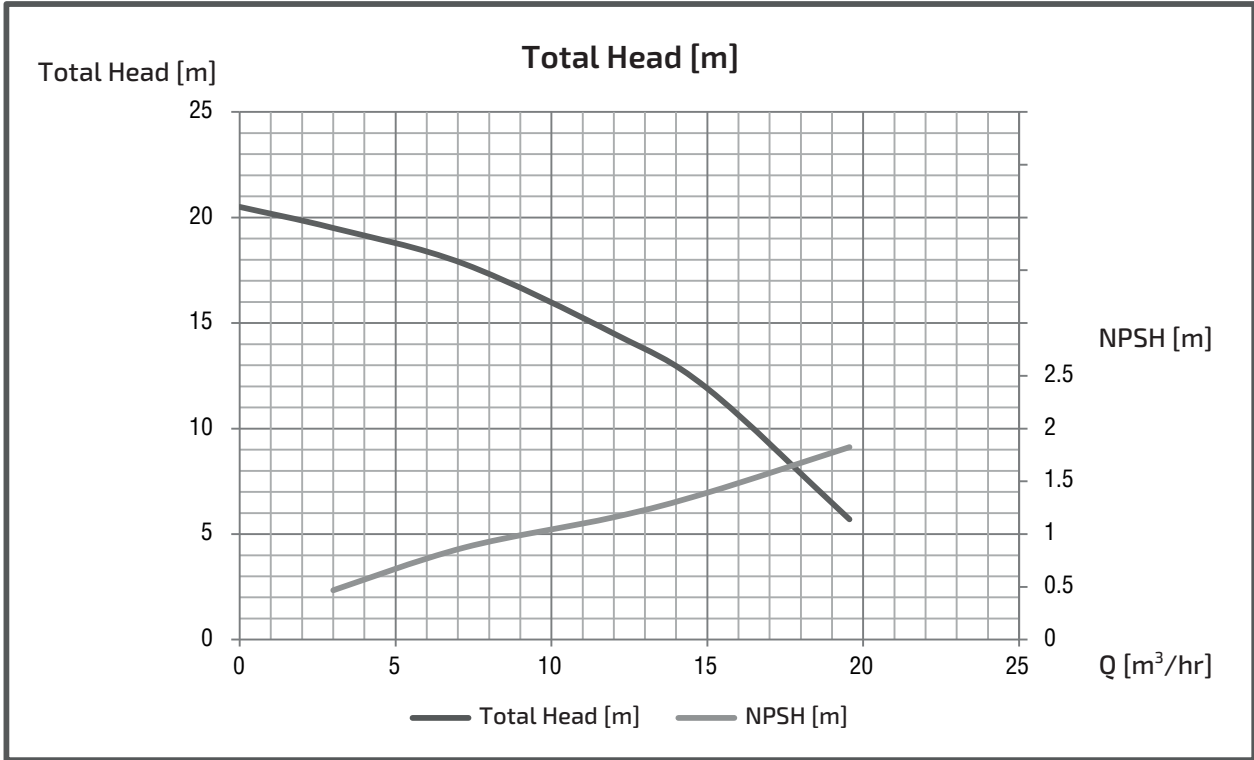

EXPECTED PERFORMANCE CURVE (GES-C)

MODEL : GES405CE1.5T4

■ PERFORMANCE CURVES

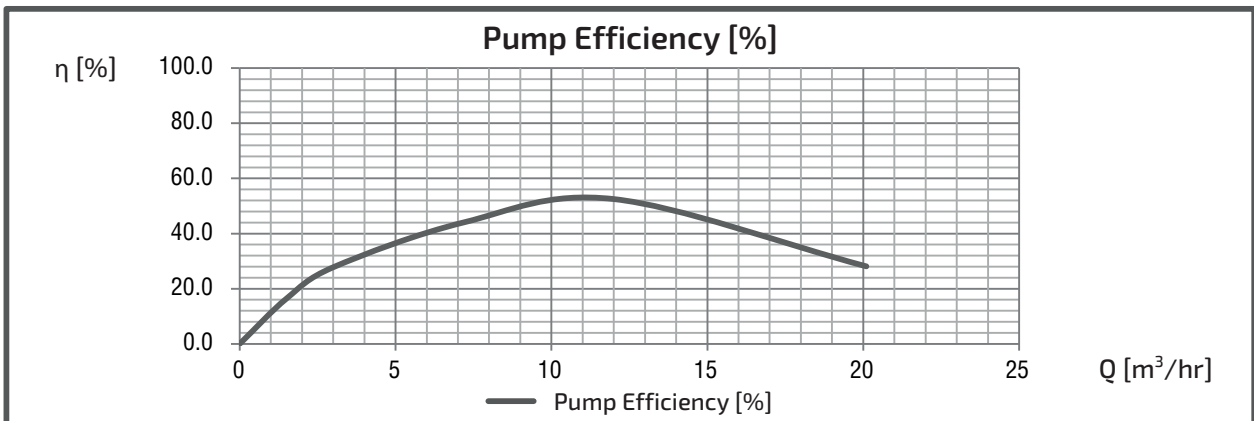
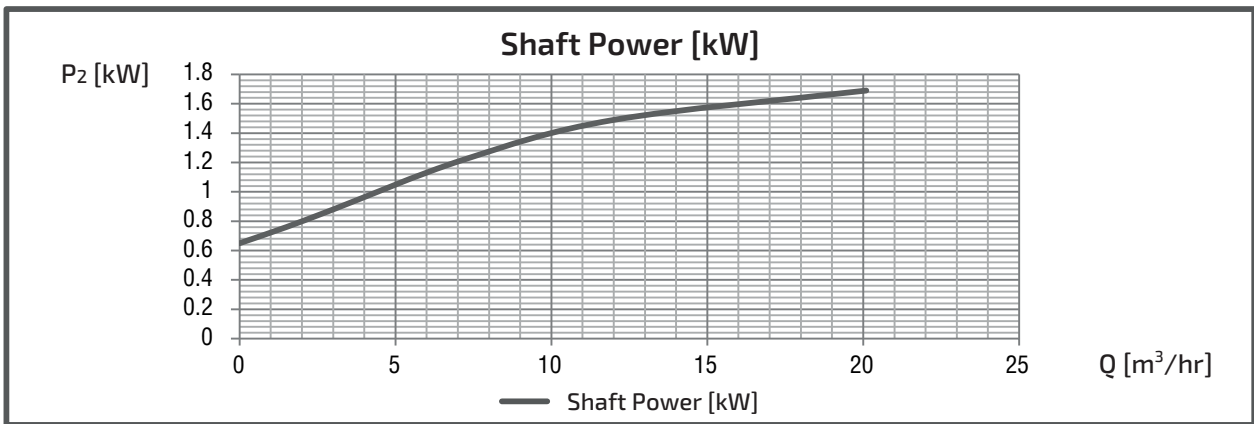
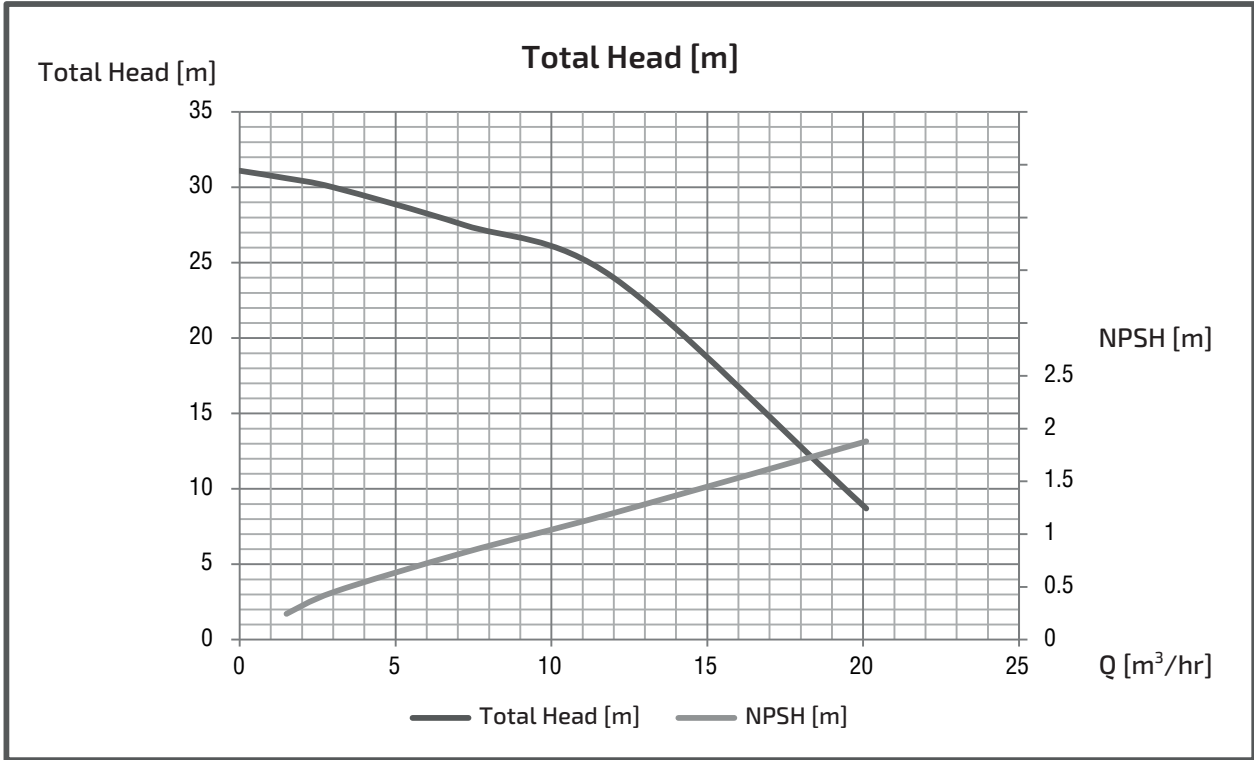

EXPECTED PERFORMANCE CURVE (GES-C)

MODEL : GES405CE2.2T4

■ PERFORMANCE CURVES

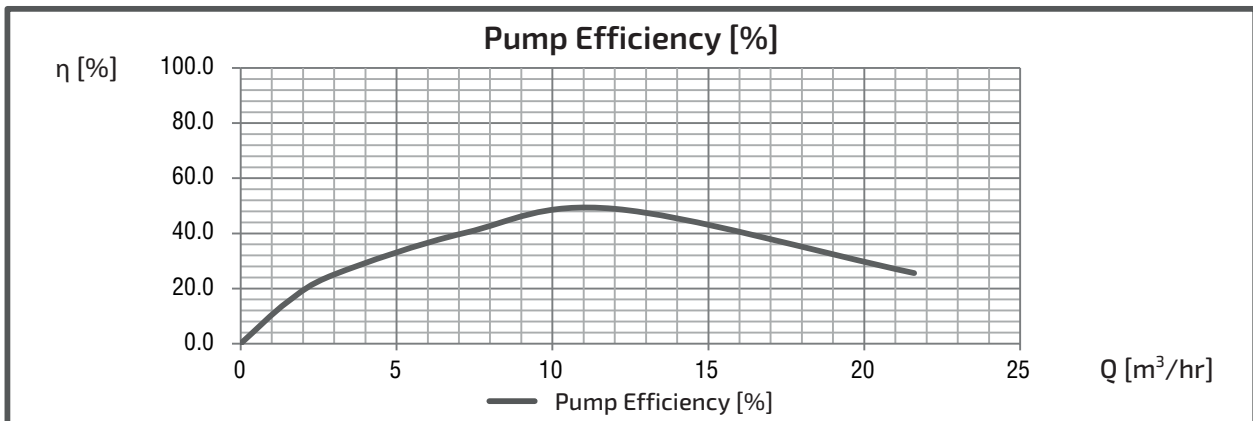
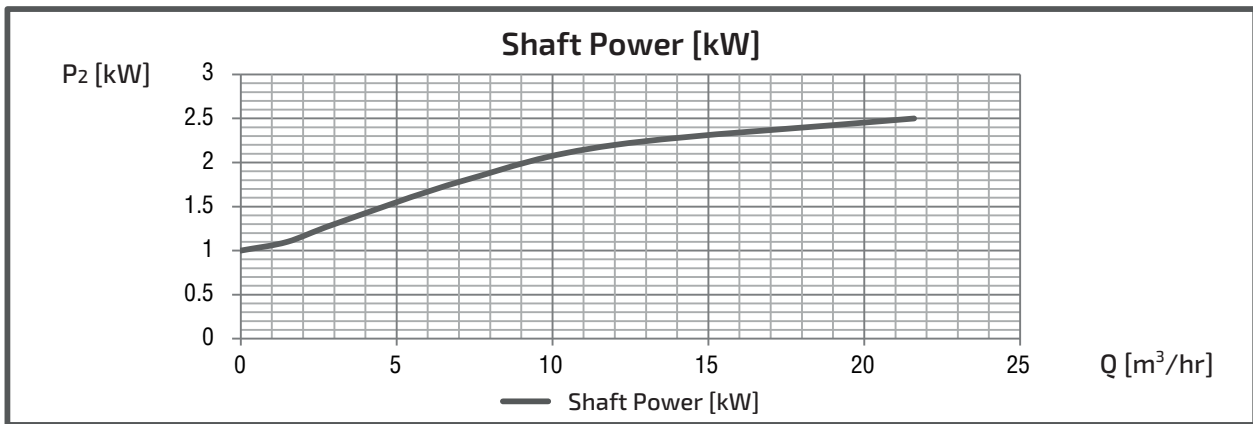
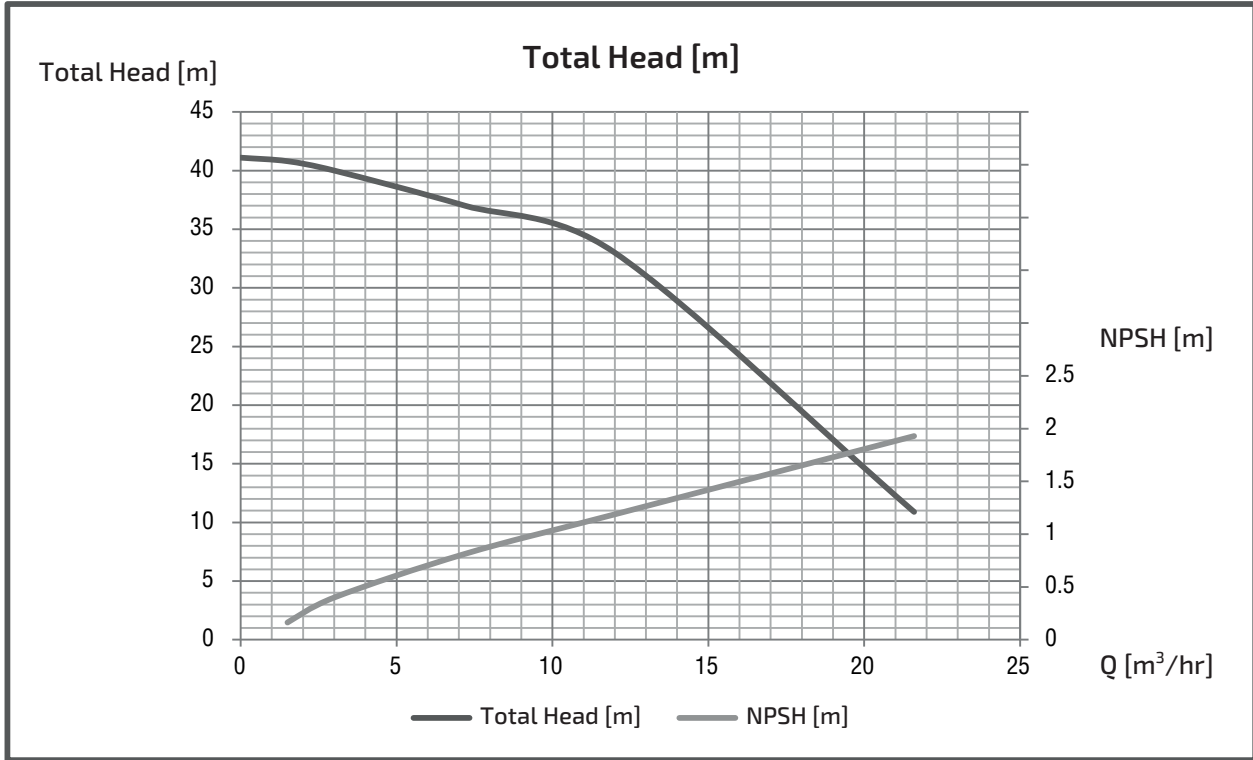

EXPECTED PERFORMANCE CURVE (GES-C)

MODEL : GES505CE1.5T4

■ PERFORMANCE CURVES

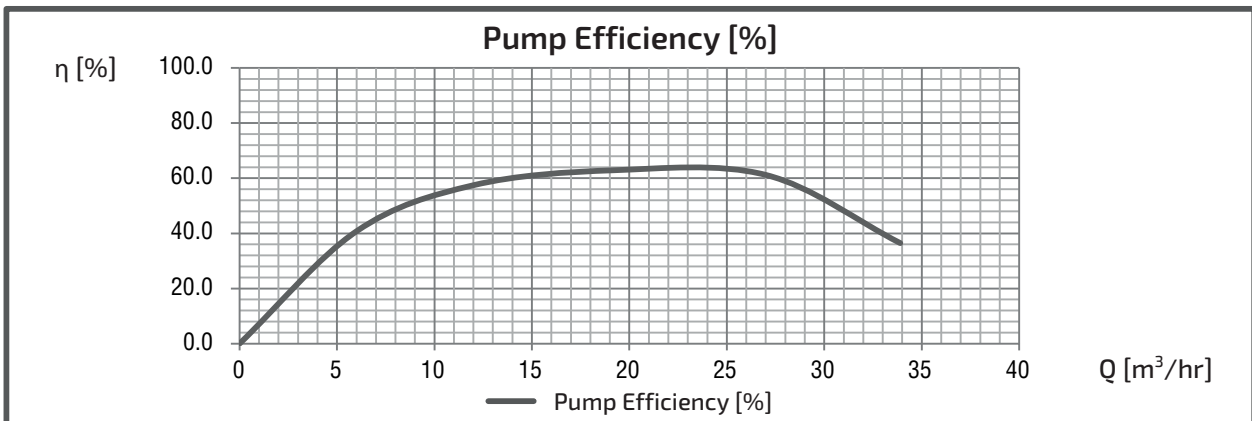
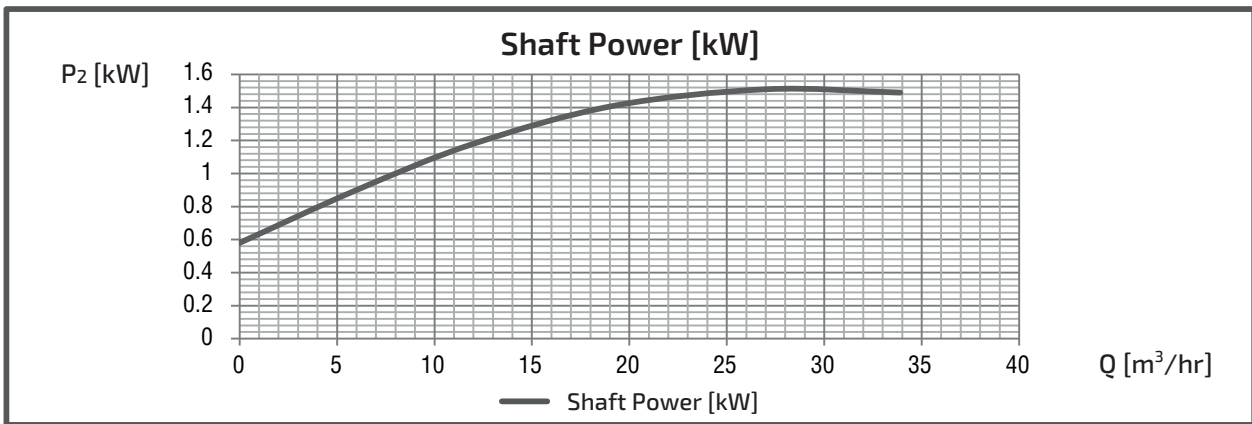
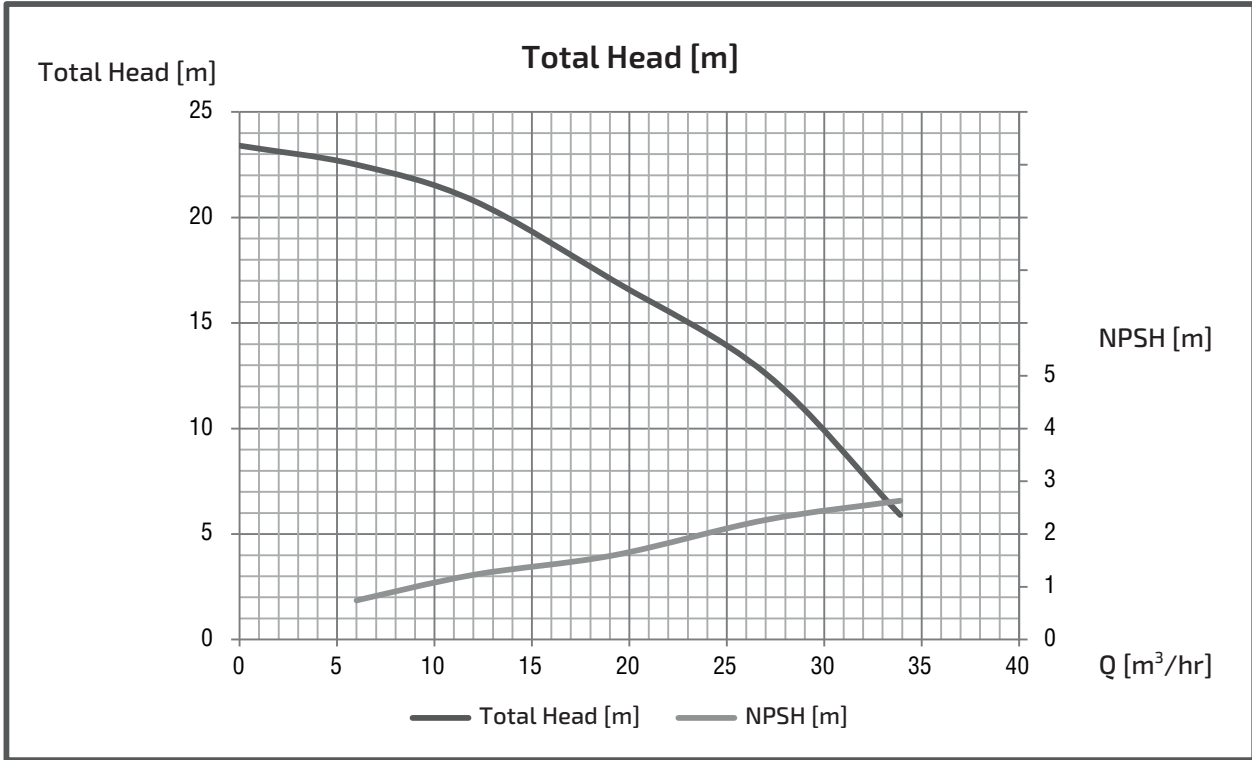

EXPECTED PERFORMANCE CURVE (GES-C)

MODEL : GES505CE2.2T4

■ PERFORMANCE CURVES

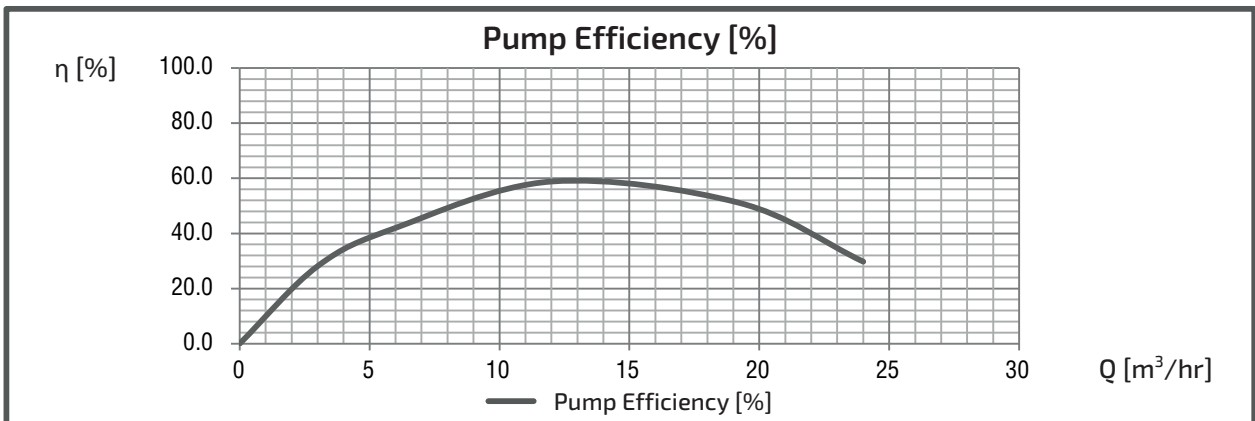
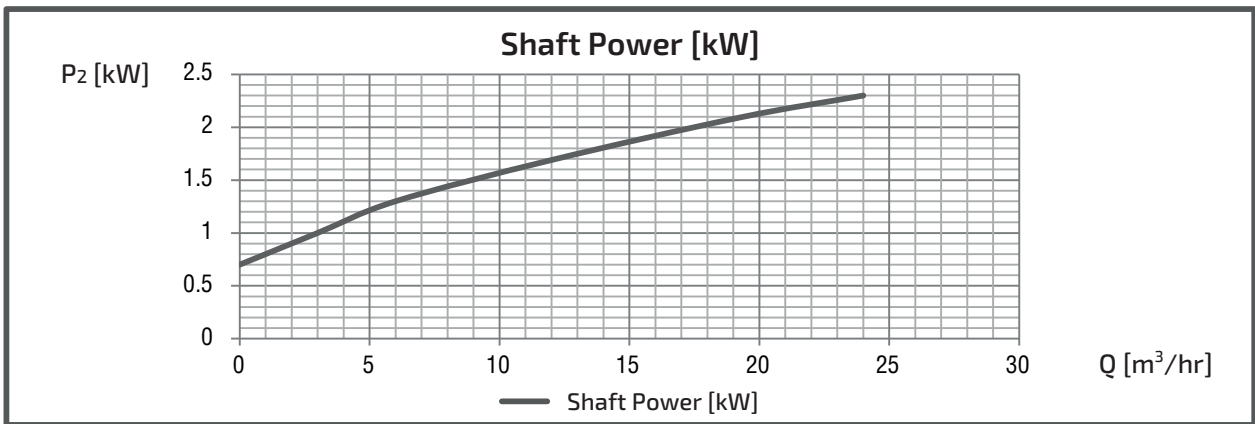
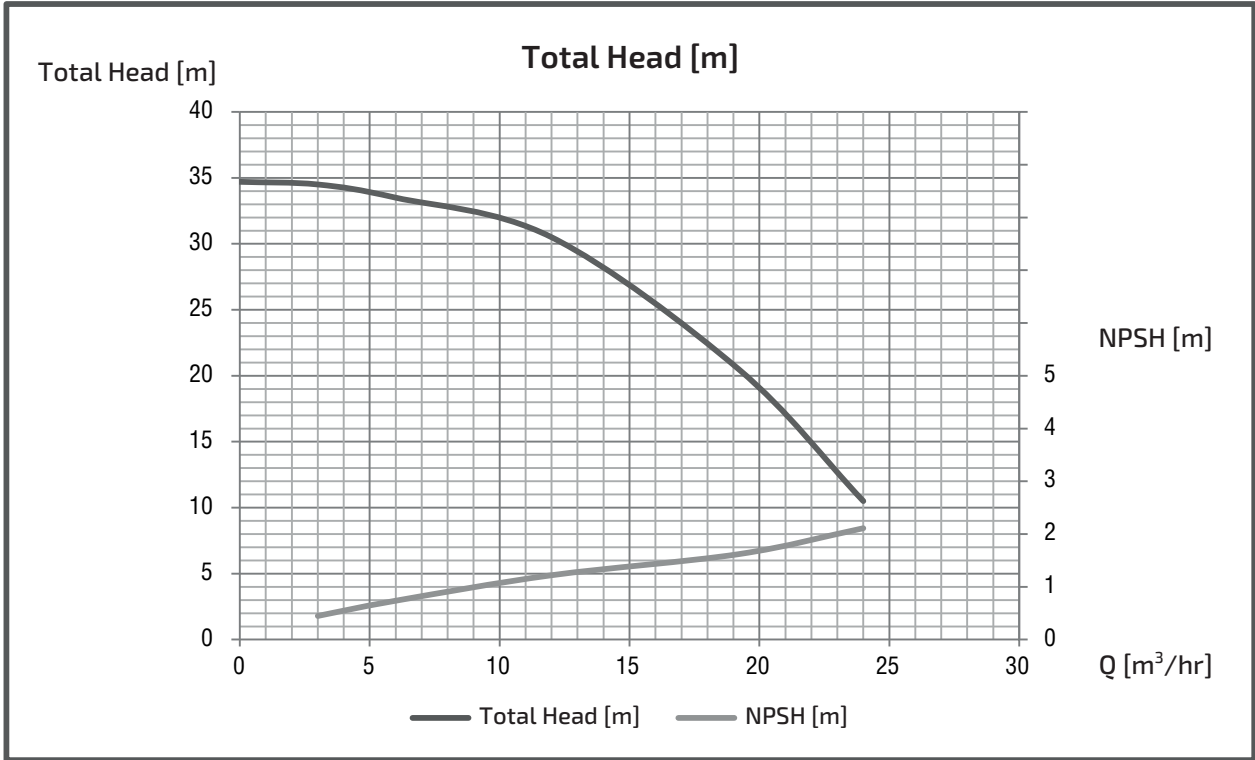

EXPECTED PERFORMANCE CURVE (GES-C)

MODEL : GES505CE3.7T4

■ PERFORMANCE CURVES

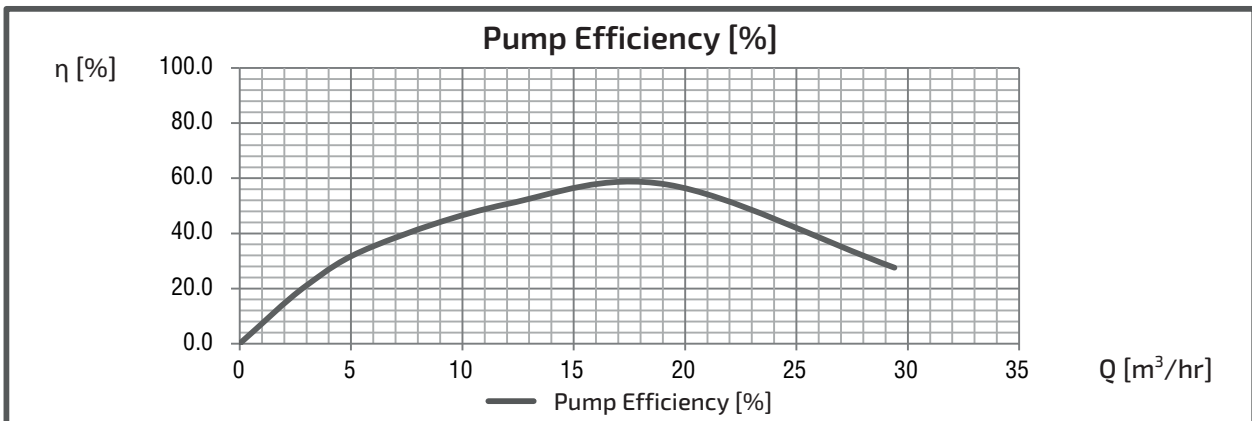
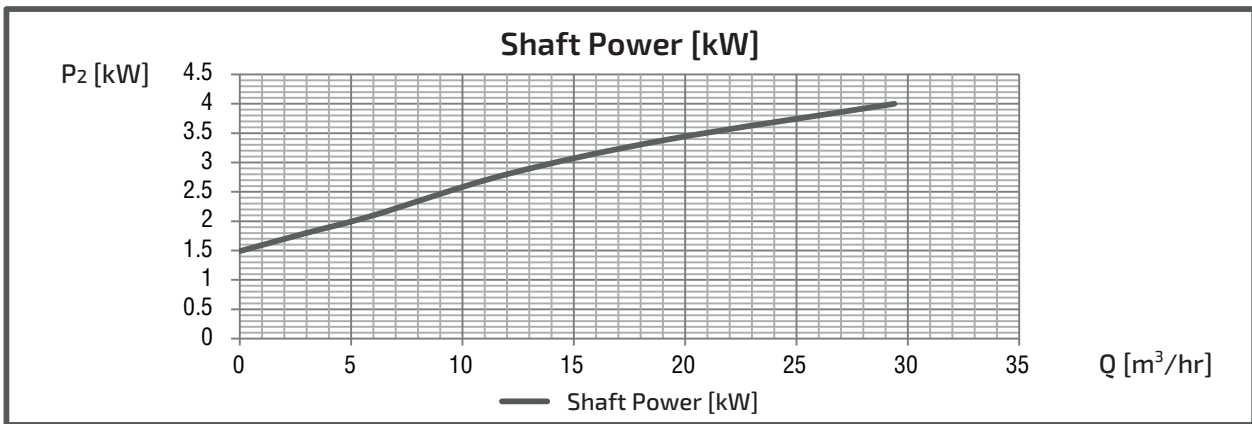
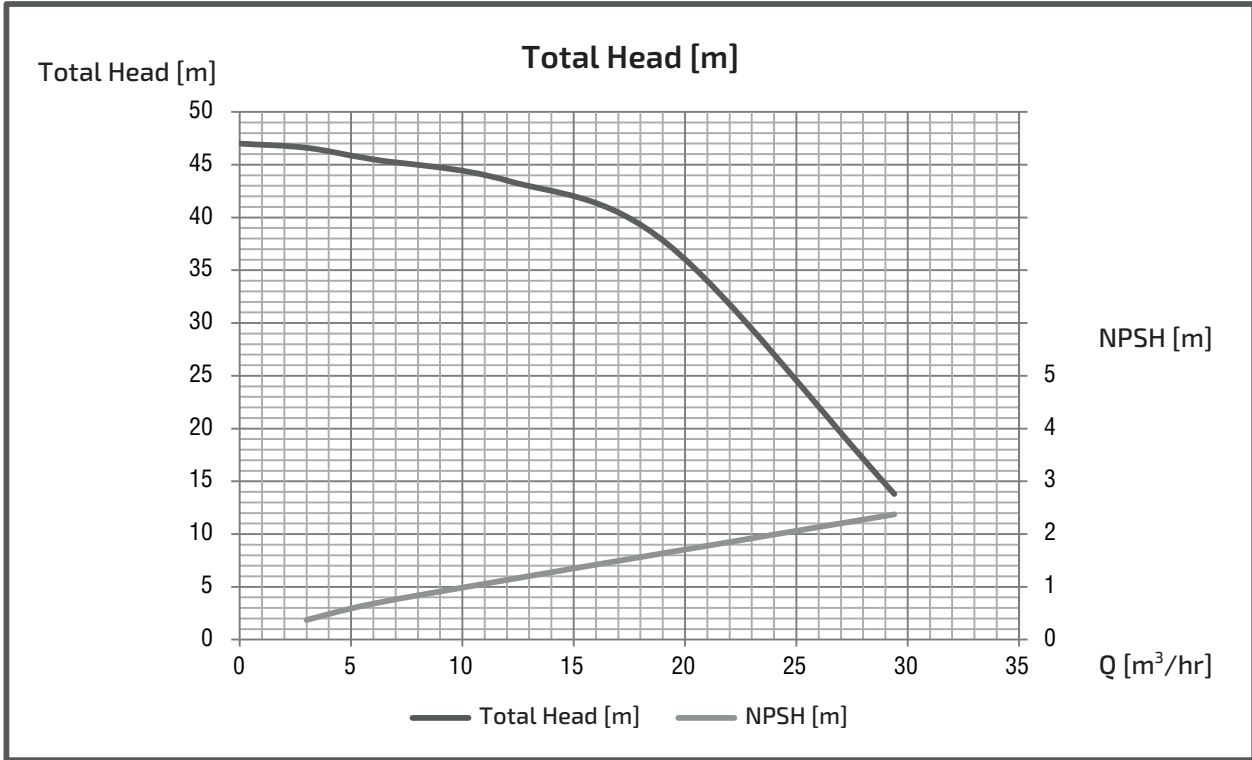

EXPECTED PERFORMANCE CURVE (GES-C)

MODEL : GES505CE5.5T4

■ PERFORMANCE CURVES

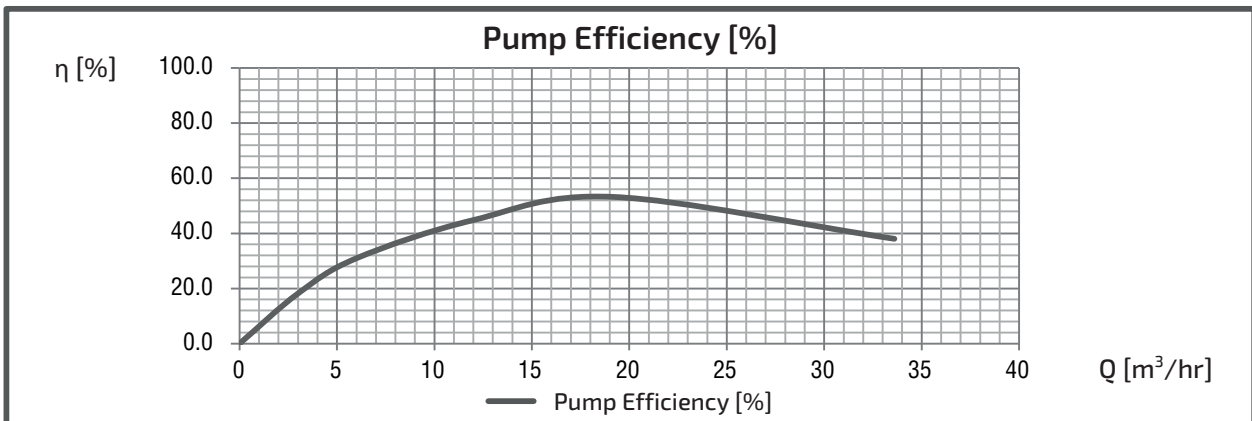
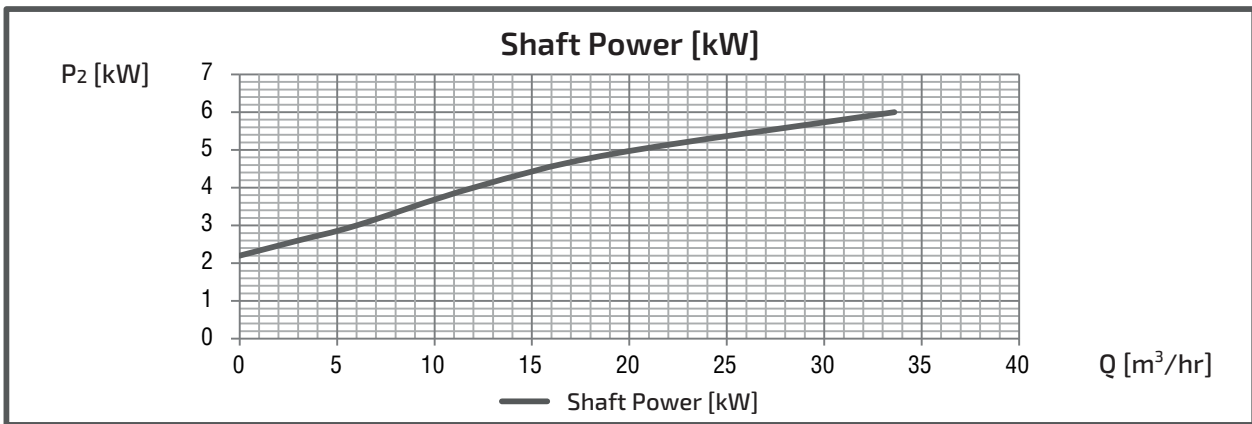
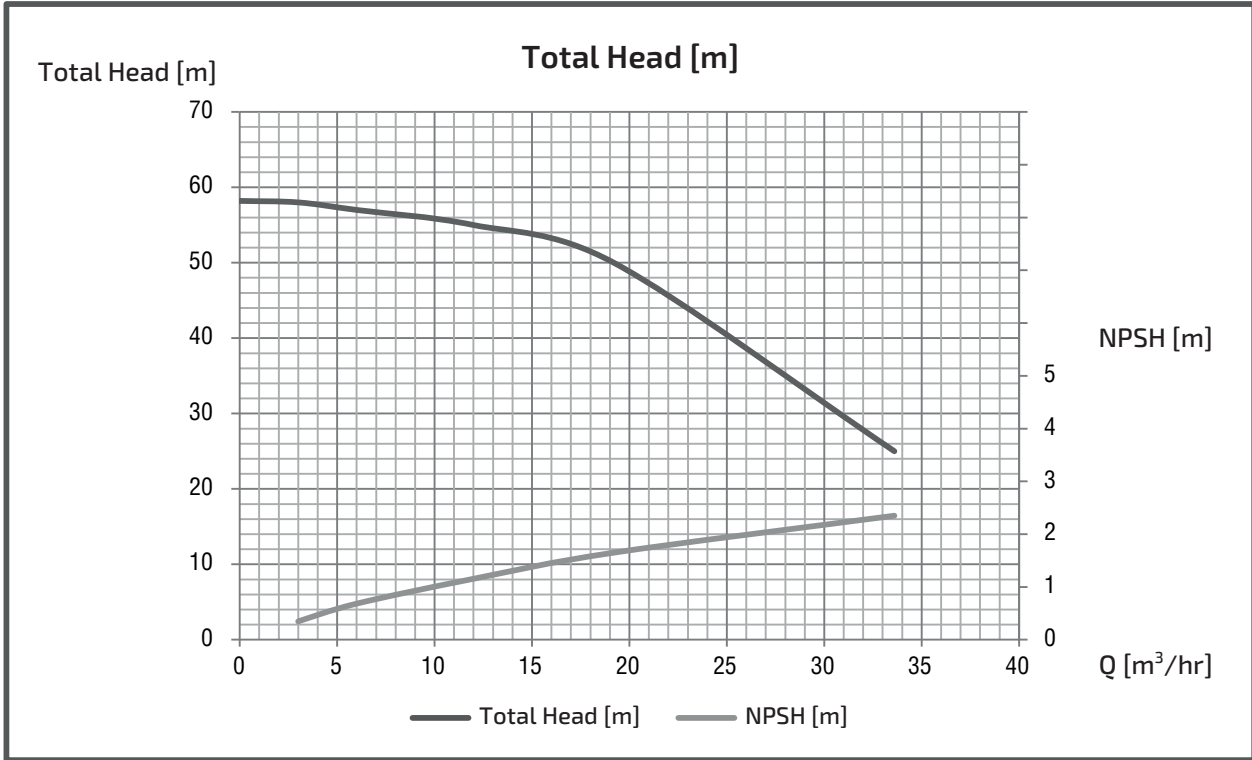

EXPECTED PERFORMANCE CURVE (GES-C)

MODEL : GES655CE3.7T4

■ PERFORMANCE CURVES

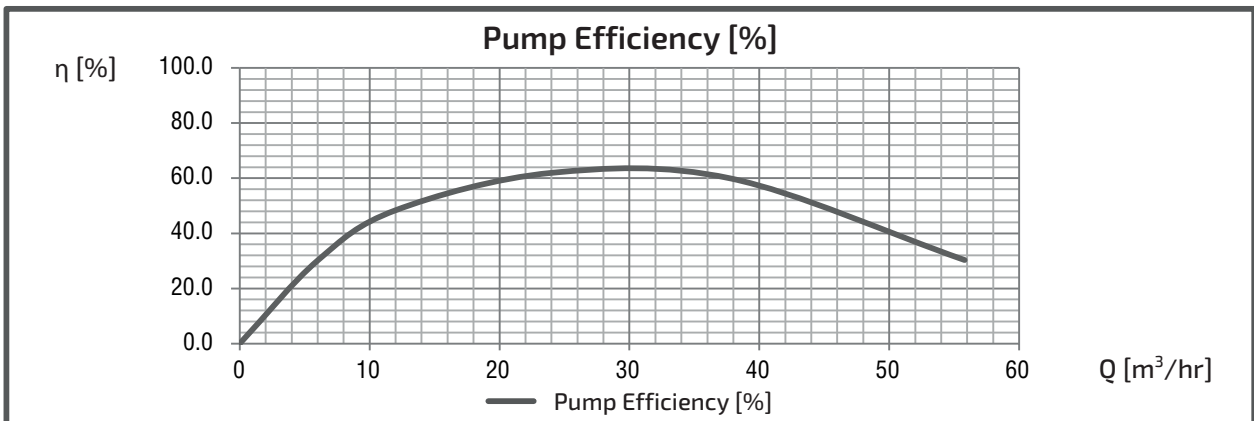
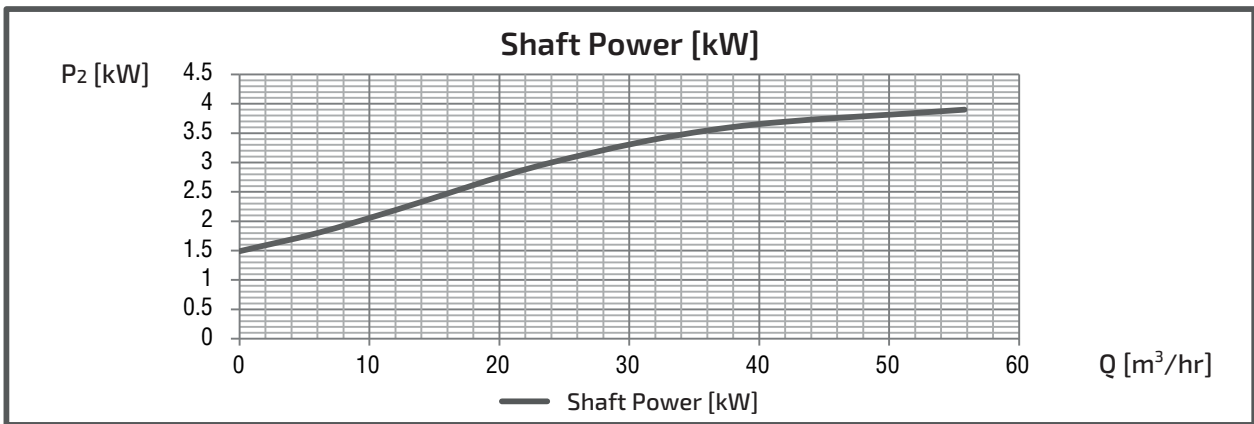
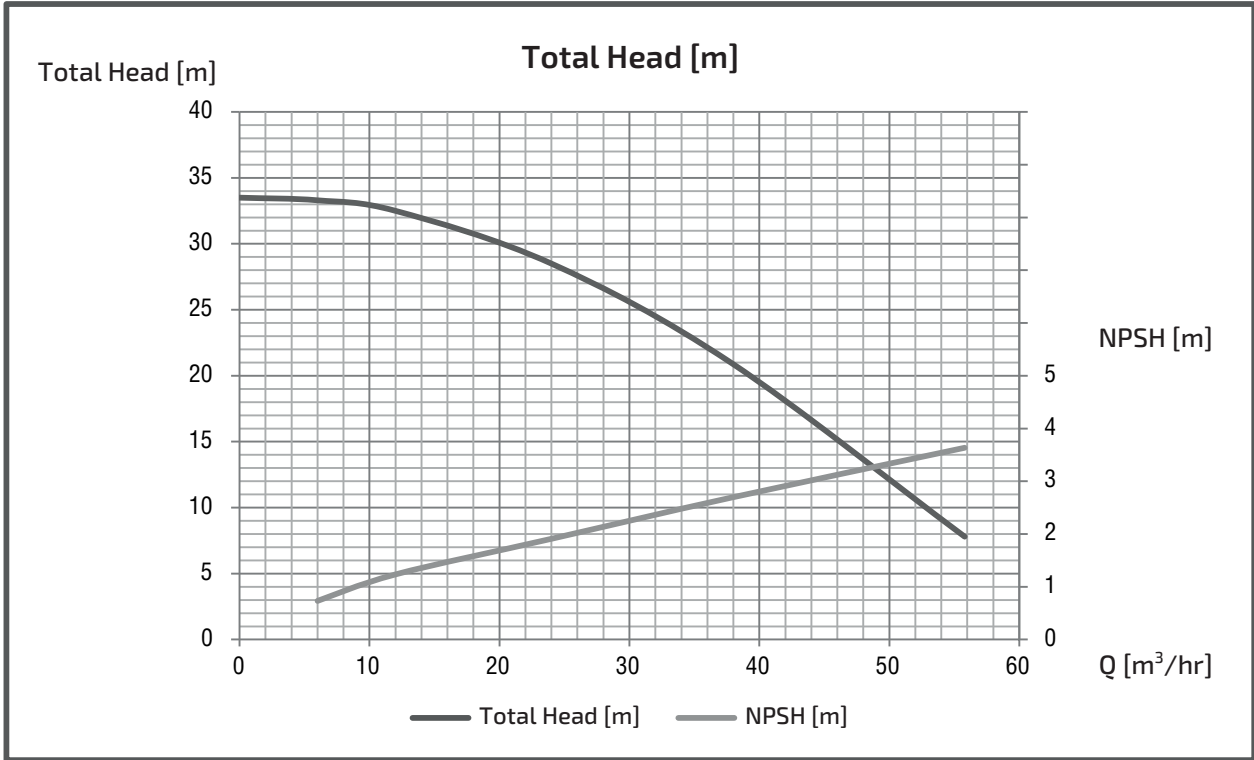

EXPECTED PERFORMANCE CURVE (GES-C)

MODEL : GES655CE5.5T4

■ PERFORMANCE CURVES

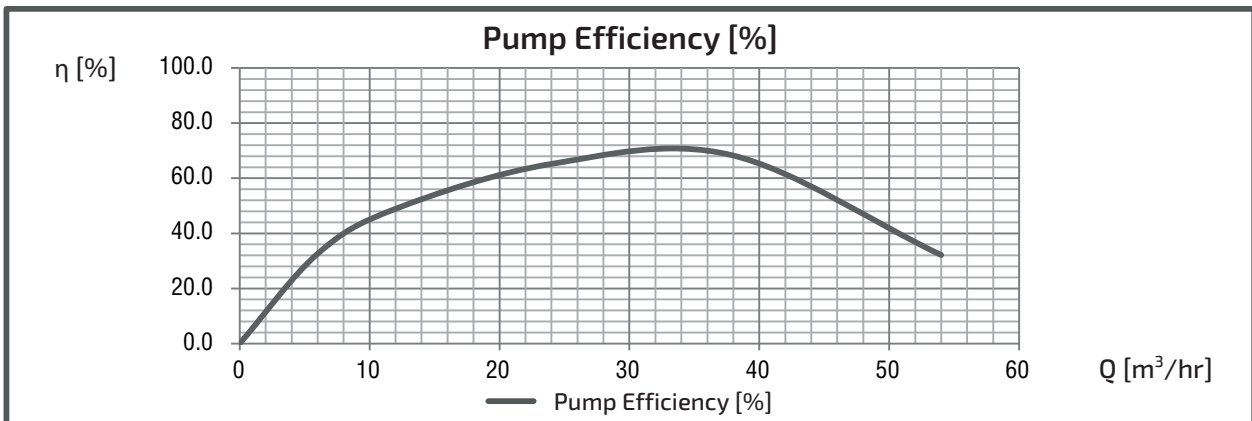
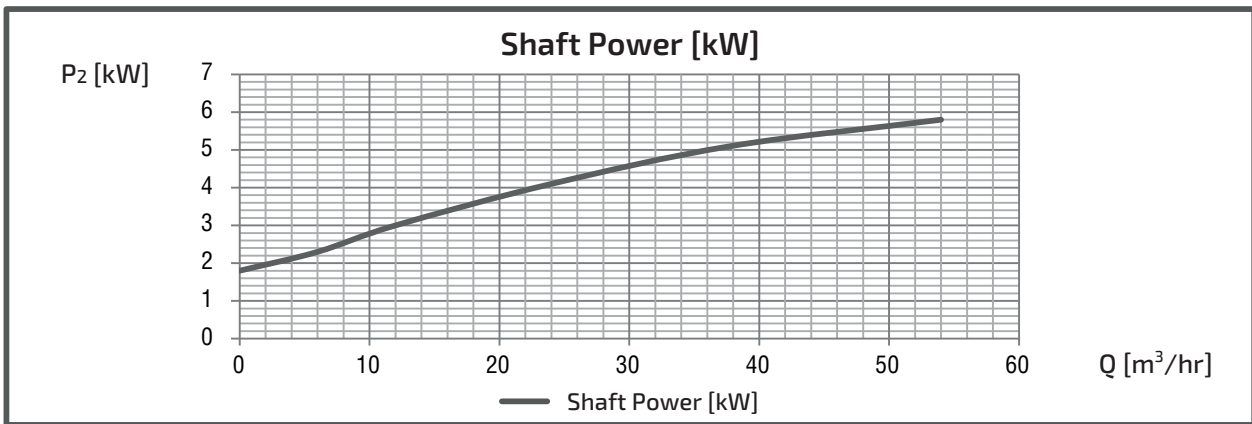
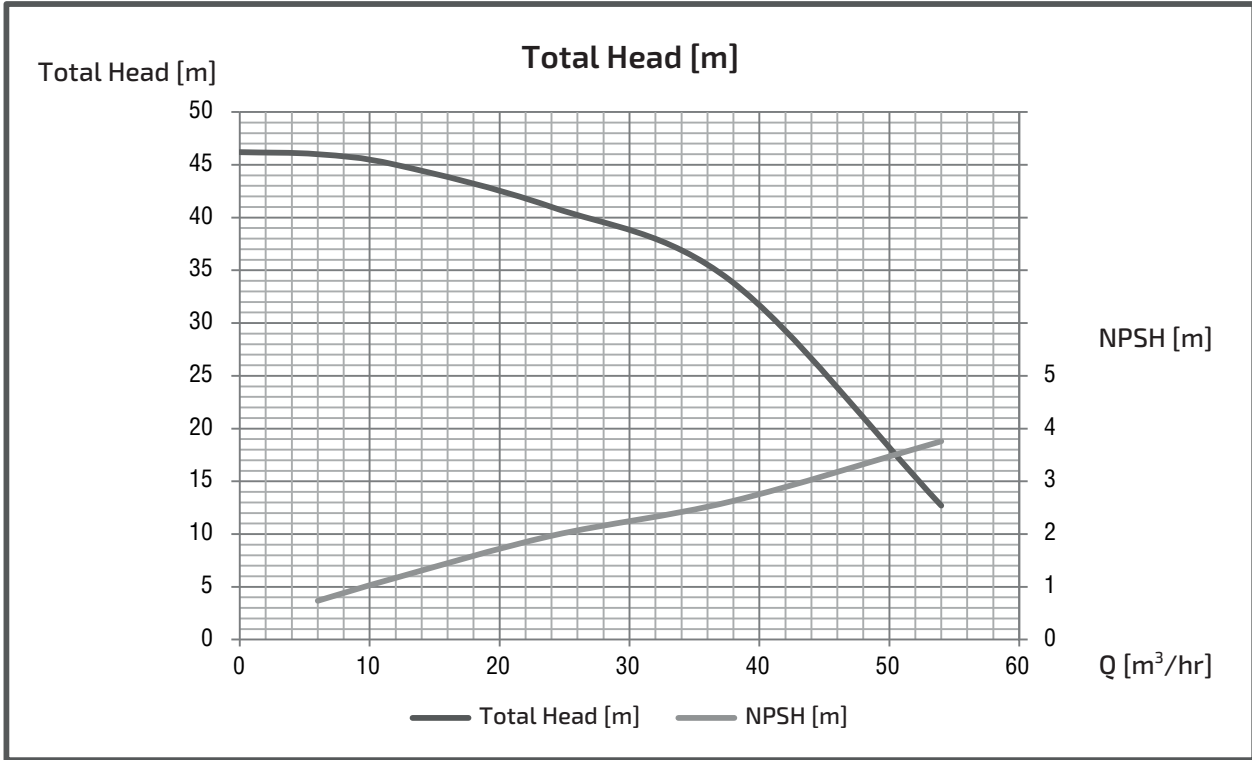

EXPECTED PERFORMANCE CURVE (GES-C)

MODEL : GES655CE7.5T4

■ PERFORMANCE CURVES

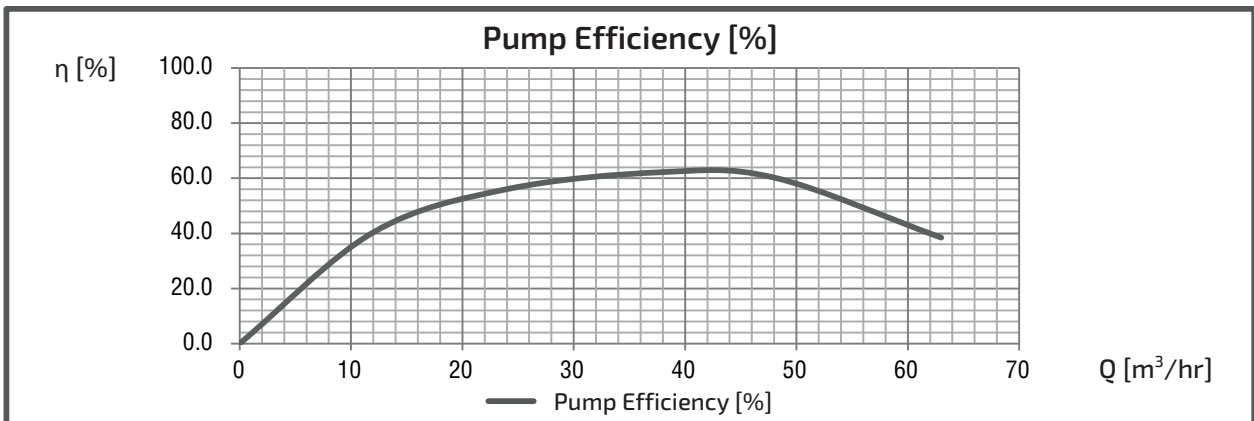
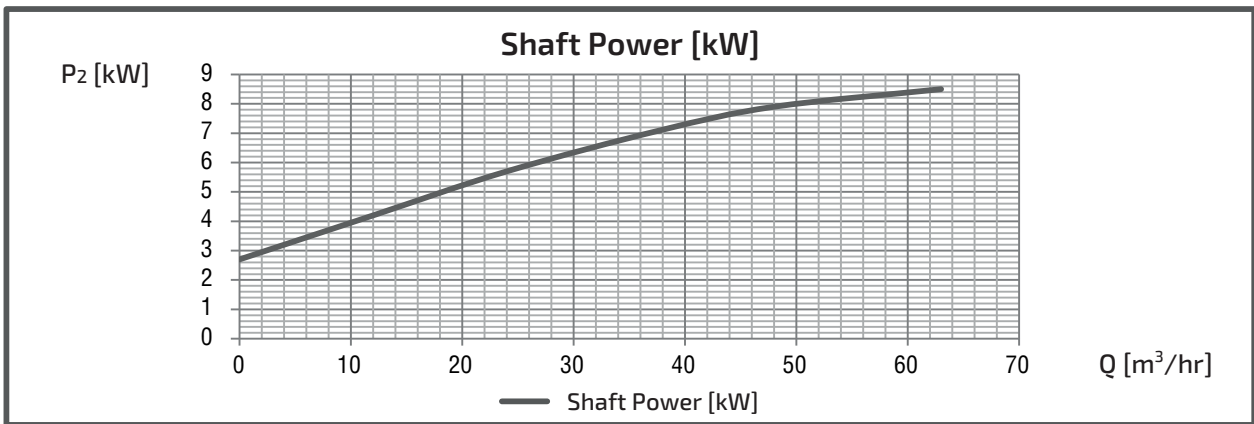
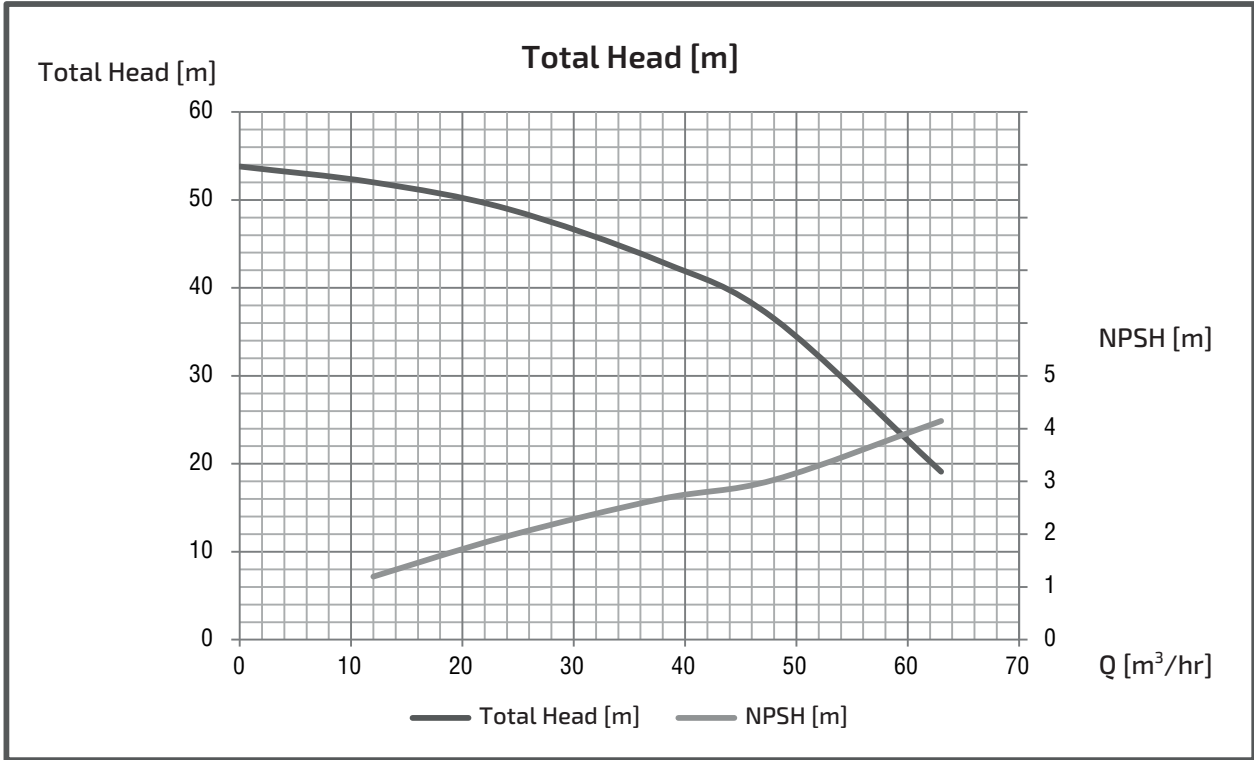

IMPORTANT SAFETY PRECAUTIONS

Always read the manual thoroughly and fully comprehend the contents for safe operation before starting use. Precautions for using products safely and for preventing personal injuries or physical damage are given in the manual.

- Matters falling under the following may not be covered by the warranty: uses out of the specified scope of application, failure to comply with precautions, improper repairs and alterations, matters arising from natural disasters, matters arising from the installation environment (improper power source, foreign objects, sand etc.), non-compliance with laws and regulations or standards pertaining thereto, accidental or intentional damage or injury, replacement of consumable parts, defects due to resale, etc.
- Do not use the product for applications out of the product specifications. Doing so may cause electric shock, fire, water leakage, etc.
- Have spare equipment ready when using pumps for equipment for living things (fish farms, fish tanks, aquariums, etc.) or critical equipment.
- Pump failure may cause lack of oxygen and water quality deterioration, and may affect the lives of the living things.
When using pumps for equipment for living things (fish farms, fish tanks, aquariums, etc.), do not install the pump in the tank where the living things are put into. The current leakage or sealing liquid leak from the mechanical seal may cause the death of the living things.
- If used to transport food-related items, give due consideration to the materials used. Contamination by foreign objects may occur.
- Avoid using for living things which disagrees with copper alloy. It may affect the lives of the living things.
- Select a product which is appropriate for your application. Inappropriate use of products may cause accidents.
- Conduct construction in accordance with the applicable laws and regulations (the Technical Standards of Electric Installation, interior wiring regulation, Building Standards Act, Water Supply Law, etc.). Not only does it violate the laws and regulations, but it also may cause injuries due to electric shock, fire, falling and tipping over.
- Do not use in places where people are assumed to get in contact with the product (baths, pools, lakes, etc.). Electric leak may occur and cause electric shock.
- Depending on the equipment, attach a filter etc. appropriate for your application on the discharge side before use, perform thorough flushing to check that there is no contamination. Cutting oil, rubber mold releasing agent, foreign objects etc. from the manufacturing line and cutting oil, foreign objects etc. from the pipeline may contaminate the liquid which is to be handled.
- Do not operate pumps with a specification of 50Hz at 60Hz. It may cause damage due to overpressure or burn damage of motors etc. due to overload. Do not operate pumps with a specification of 60Hz at 50Hz. Pump performance may be reduced.
- Only repair technicians may disassemble, repair, modify the product or replace cables. Defects may cause failure, damage, electrification or fire.
- It is recommended that both periodic and daily inspections be performed in order to ensure that the pump will operate reliably for as long as possible. Failure to perform inspections may lead to pump failure, accidents etc. For periodic inspections, please consult your distributor or our nearest sales office.

Note

Specifications/Configurations may be altered as a result of improvements and such.
Unauthorized reproduction of this document is prohibited.