



Submersible Sewage Pumps
Vortex Impeller

U/UZ



Featuring a vortex impeller recessed in the widely opened pump casing interior, the U and UZ pumps can handle sewage with large solids without clogging or winding.

Cable Entry

Every cable has an anti-wicking block at the cable entry section on the pump. This mechanism is such that a part of each conductor is stripped back and the part is sealed by molded rubber or epoxy potting which has flowed in between each strand of the conductor.



This unique feature prevents wicking along the strand of the conductor itself.

Mechanical Seal

The mechanical seal with two seal faces containing silicon carbide (SiC) is equipped with the oil chamber. The advantages of the seal are two-fold, it eliminates spring failure caused by corrosion, abrasion or fouling which prevents the seal faces from closing properly, and prevents loss of cooling to the lower seal faces during run-dry conditions which causes the lower seal faces to fail.



Oil Lifter (Patented)

The Oil Lifter was developed as a lubricating device for the mechanical seal. Utilizing the centrifugal force of the shaft seal, the Oil Lifter forcibly supplies lubricating oil to the mechanical seal and continues to supply the oil to the upper seal faces even if lubricant falls below the rated volume. This amazingly simple device is not only reliably lubricates and cools down, but also retains the stable shaft seal effect and extends the inspection term.

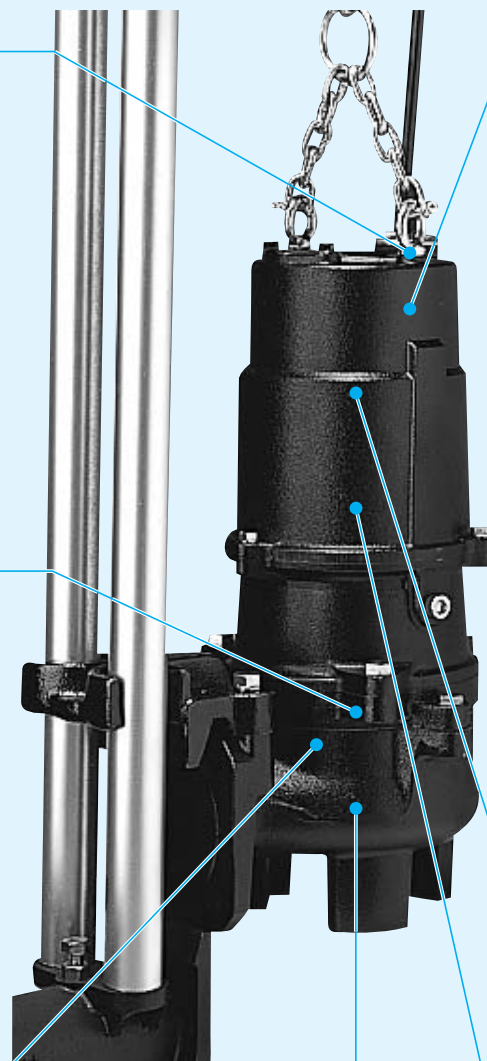
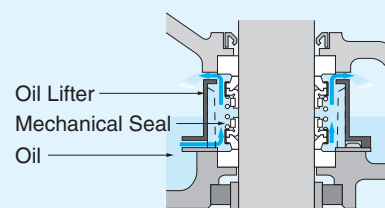

Motor Protector

Each pump up to 7.5kW as standard has a built in auto-cut, self-resetting Circle Thermal Protector (CTP). Integrated in the motor housing, the CTP directly cuts the motor circuit if excessive heat builds up or an overcurrent caused by an electrical or mechanical failure occurs.

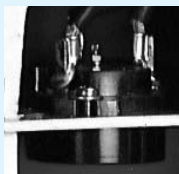

A Miniature Thermal Protector (MTP) is embedded in each winding of the motor. These MTPs are connected in series, and their wires are led out of the motor. Should the winding temperature rise to the actuating temperature, the bimetal strip opens to cause the control panel to shut the power supply.

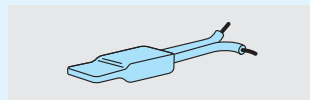

Motor

The motor is a dry-type, squirrel-cage induction motor, housed in a watertight casing, and conforms to insulation classes E or F. In each of these insulation classes, all standard pumps can be used in ambient temperatures up to 40°C.

Shaft

The high-tensile stainless steel shaft used on all pumps is designed to have adequate strength for the transmission of the full load. It is supported by C3 type, high-quality, deep-groove ball bearings.

Impeller

The impeller is a vortex type. The rotation of the impeller produces a whirling, centrifugal action between the impeller and pump casing. Being coupled with a wide pump casing, even large solids and fibrous matters can be pumped out without obstruction.

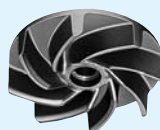

MODEL NUMBER DESIGNATION

100	UZ	A	4	3.7	S
Discharge bore in millimeters	Name of the series	Operation sub code	Number of poles of the motor	Rated motor output in kilowatts	Phase
		None : None automatic operation A : Automatic operation W : Auto-alternation operation			None : Three-phase S : Single-phase

(This model does not exist.)

GUIDE RAIL FITTING SYSTEM

The guide rail fitting system connects the pump to and from the piping easily just by lowering and hoisting the pump, allowing easy maintenance and inspection without the need to enter the sump.

Pump models used in combination with the guide rail fitting system can be identified by the prefix "TOS", "TS" and "TOK". Refer to standard specifications for availability and model numbers.

TOS

The TOS is the standard guide rail fitting system made of cast-iron and is compatible with cast-iron pumps. Pumps having discharge bore from 50mm to 100mm are available for the TOS.



TS

This compact guide rail fitting system is ideal for installing in prefabricated lift stations. Its discharge flange is compatible with major flange standards including ANSI 150lb, BS PN10 and DIN PN10. Pumps having a discharge bore from 50mm to 100mm are available for the TS.



TOK

Made of high-quality resin, the TOK is designed for light-weight, small pumps. Rubber bellow attached to the guide hook are inverted to the duckfoot bend when the pump starts operating. This eliminates leakage at the seal even if a light-weight pump is used in combination with the TOK.

The TOK can be used with the U series pumps of 0.25kW to 0.75kW with maximum discharge bore of 50mm.



AUTOMATIC MODEL

The automatic model has an integral control circuit and two float switches that operate at a low voltage. It operates automatically in response to the change in water levels. As it has a Circle Thermal Protector (CTP) integrated into the motor to protect the motor from overload or overheating, it is not required to provide an extra motor protection circuit in the starter panel.

This model can be identified by the suffix "A". Refer to the standard specifications for availability and model numbers.



AUTO-ALTERNATION MODEL

The auto-alternation model is used along with an automatic model. The combinational use of these two pumps enables each pump to operate alternately without control panel.

The auto-alternation model has three floats and can be identified by the suffix "W". Refer to standard specifications for availability and model numbers. It is available in the same output range of the automatic pumps.

How the Auto-alternation Model Works

● Operation is enabled by merely connecting the power supply.

Primary Operation

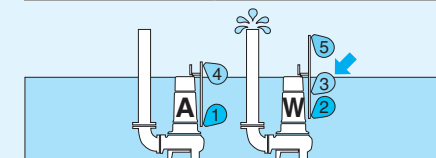

1 Float 3 operates, and pump W starts to discharge water.

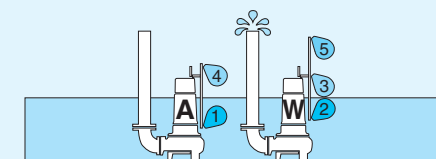

2 Water is discharged (water level falls).

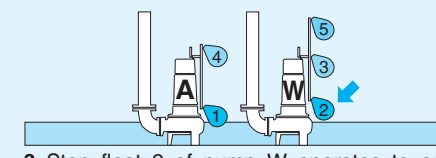

3 Stop float 2 of pump W operates to end water discharge. At this time, alternation start float 3 of pump W rests for one discharge operation.

Secondary Operation

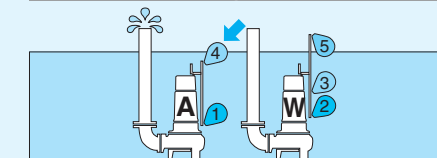

1 Start float 4 of pump A operates to start water discharge.

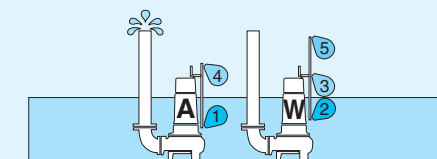

2 Water is discharged (water level falls).

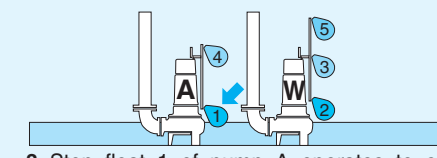

3 Stop float 1 of pump A operates to end water discharge. At the same time, start float 3 of pump W becomes ready for operation.

※ Primary operation and secondary operation are repeated alternately.

※ Both primary and secondary operations are performed simultaneously when water has risen to an abnormal level.

Performance Curves

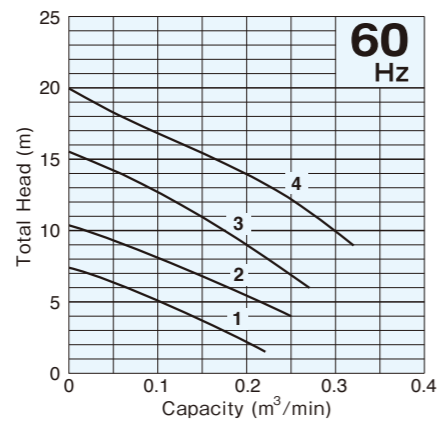
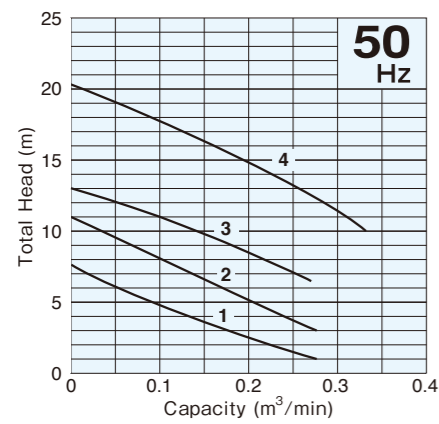

Dimensions

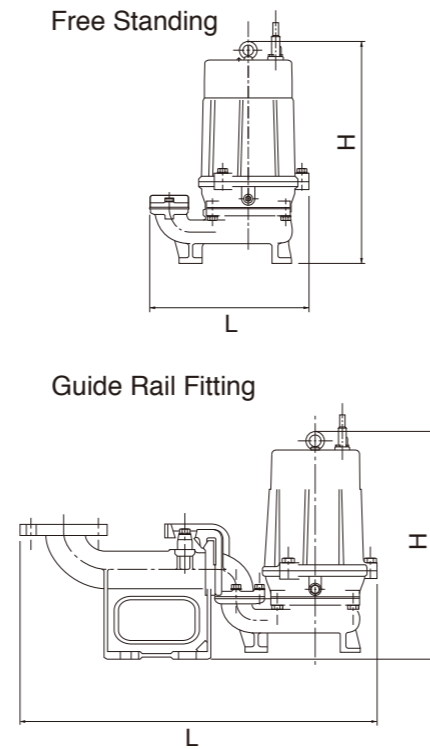

Performance Curves

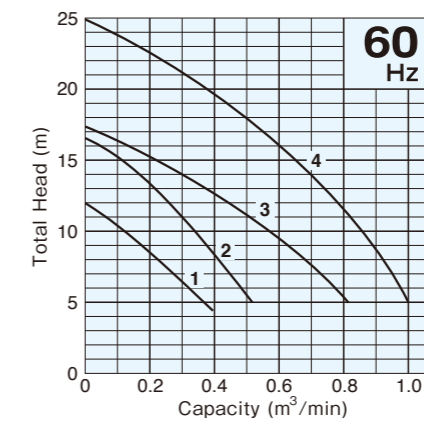
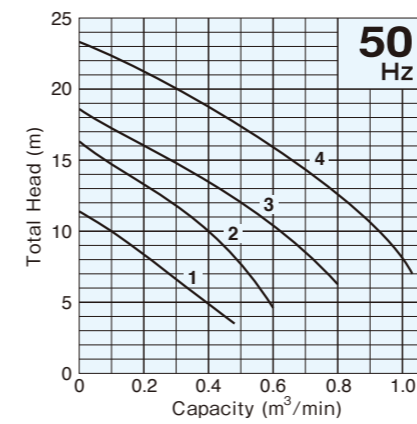

Dimensions

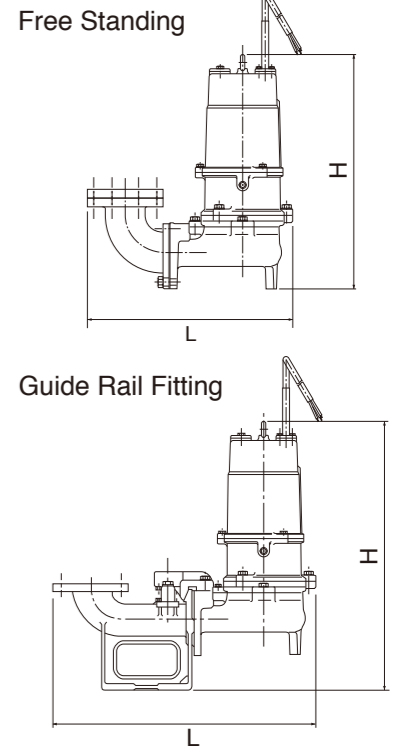

Model Selection 40 · 50mm

Curve No.	Discharge Bore mm	Standard Model		Automatic Model		Auto-Alternation Model		Motor Output kW	Phase	Speed (S.S.) 50Hz/60Hz min ⁻¹	Starting Method	Solids Passage mm	Cable Length m	Cable Code	Dimensions L×H mm				Dry Weight * kg			
		Free Standing	Guide Rail Fitting	Free Standing	Guide Rail Fitting	Free Standing	Guide Rail Fitting								Standard Model		Auto & Auto-Alternation Model		Standard Model		Auto & Auto-Alternation Model	
															Free Standing	Guide Rail Fitting	Free Standing	Guide Rail Fitting	Free Standing	Guide Rail Fitting	Free Standing	Guide Rail Fitting
1	40	40U2.25S	(TOK)	40UA2.25S	(TOK)	40UW2.25S	(TOK)	0.25	Single	3000/3600	Split-phase	35	5	a	241×383	—	241×433	—	14.0	—	15.5	—
	40	40U2.25	(TOK)	40UA2.25	(TOK)	40UW2.25	(TOK)	0.25	Three	3000/3600	D.O.L.	35	6	A	241×383	—	241×433	—	13.5	—	15.0	—
2	50	50U2.4S	(TOK)	50UA2.4S	(TOK)	50UW2.4S	(TOK)	0.4	Single	3000/3600	Capacitor	35	5	a	236×433	—	236×450	—	20.0	—	21.0	—
	50	50U2.4	(TOK)	50UA2.4	(TOK)	50UW2.4	(TOK)	0.4	Three	3000/3600	D.O.L.	35	6	A	236×400	—	236×450	—	19.2	—	21.0	—
3	50	50U2.75	(TOK)	50UA2.75	(TOK)	50UW2.75	(TOK)	0.75	Three	3000/3600	D.O.L.	35	6	A	249×395	—	310×476	—	23.0	—	24.0	—
4	50	50U21.5	TOS50U21.5	50UA21.5	TOS50UA21.5	50UW21.5	TOS50UW21.5	1.5	Three	3000/3600	D.O.L.	35	6	A	297×466	658×478	347×560	708×572	30.0	35.0	31.0	36.0

* All weights excluding cable
Weights of guide rail fitting model excluding duckfoot bend

Model Selection 80mm

Curve No.	Discharge Bore mm	Standard Model		Automatic Model		Auto-Alternation Model		Motor Output kW	Phase	Speed (S.S.) 50Hz/60Hz min ⁻¹	Starting Method	Solids Passage mm	Cable Length m	Cable Code	Dimensions L×H mm				Dry Weight *2 kg			
		Free Standing	Guide Rail Fitting	Free Standing	Guide Rail Fitting	Free Standing	Guide Rail Fitting								Standard Model		Auto & Auto-Alternation Model		Standard Model		Auto & Auto-Alternation Model	
															Free Standing	Guide Rail Fitting	Free Standing	Guide Rail Fitting	Free Standing	Guide Rail Fitting	Free Standing	Guide Rail Fitting
1	80	80U2.75	TOS80U2.75	80UA2.75	TOS80UA2.75	80UW2.75	TOS80UW2.75	0.75	Three	3000/3600	D.O.L.	46	6	A	383×421	605×531	444×502	666×612	29.0	24.0	30.0	26.0
2	80	80U21.5	TOS80U21.5	80UA21.5	TOS80UA21.5	80UW21.5	TOS80UW21.5	1.5	Three	3000/3600	D.O.L.	46	6	A	420×499	642×609	469×593	691×703	40.0	36.0	41.0	37.0
3	80	80U22.2	TOS80U22.2	80UA22.2	TOS80UA22.2	80UW22.2	TOS80UW22.2	2.2	Three	3000/3600	D.O.L.	56	6	A(B*1)	502×562	641×647	502×656	641×741	55.0	51.0	63.0	59.0
4	80	80U23.7	TOS80U23.7	80UA23.7	TOS80UA23.7	80UW23.7	TOS80UW23.7	3.7	Three	3000/3600	D.O.L.	56	6	B(C*1)	502×565	641×650	502×629	641×714	62.0	58.0	73.0	69.0

*1 200~240V
*2 All weights excluding cable
Weights of guide rail fitting model excluding duckfoot bend

UZ 50·80mm

Performance Curves

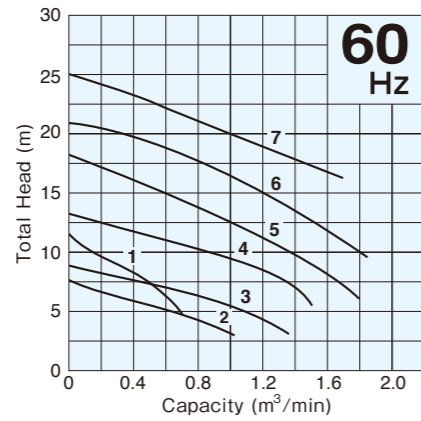
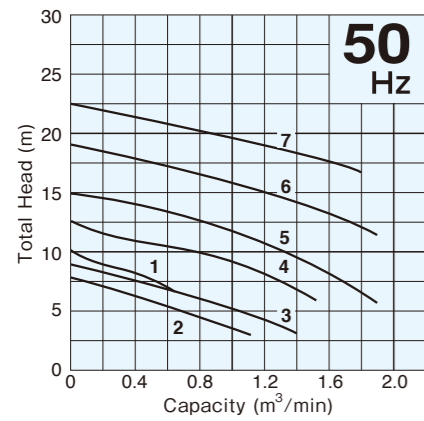

Dimensions

Free Standing

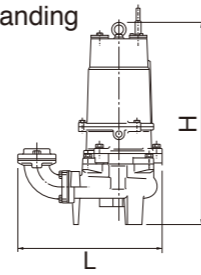

Guide Rail Fitting

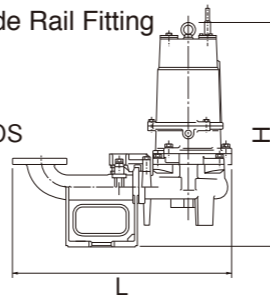

TS

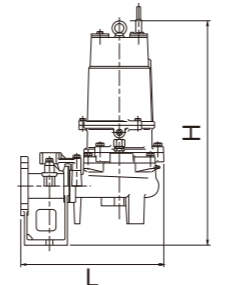

Model Selection 50 · 80mm

Curve No.	Discharge Bore mm	Standard Model			Automatic Model			Auto-Alternation Model			Motor Output kW	Phase	Speed (S.S.) 50Hz/60Hz min ⁻¹	Starting Method	Solids Passage mm	Cable Length m	Cable Code	Dimensions L×H mm						Dry Weight *2 kg			
		Free Standing	Guide Rail Fitting		Free Standing	Guide Rail Fitting		Free Standing	Guide Rail Fitting									Standard Model			Auto&Auto-Alternation Model			Standard Model		Auto&Auto-Alternation Model	
			TOS	TS		TOS	TS		TOS	TS								Free Standing	TOS	TS	Free Standing	TOS	TS	Free Standing	Guide Rail Fitting	Free Standing	Guide Rail Fitting
1	50	50UZ41.5	TOS50UZ41.5	TS50UZ41.5	50UZA41.5	TOS50UZA41.5	TS50UZA41.5	50UZW41.5	TOS50UZW41.5	TS50UZW41.5	1.5	Three	1500/1800	D.O.L.	50	6	A	405×566	621×626	398×626	442×683	658×743	435×743	52.0	50.0	58.0	56.0
2	80	80UZ41.5	TOS80UZ41.5	TS80UZ41.5	80UZA41.5	TOS80UZA41.5	TS80UZA41.5	80UZW41.5	TOS80UZW41.5	TS80UZW41.5	1.5	Three	1500/1800	D.O.L.	80	6	A	531×637	705×670	552×670	565×754	738×787	585×787	66.0	56.0	73.0	63.0
3	80	80UZ42.2	TOS80UZ42.2	TS80UZ42.2	80UZA42.2	TOS80UZA42.2	TS80UZA42.2	80UZW42.2	TOS80UZW42.2	TS80UZW42.2	2.2	Three	1500/1800	D.O.L.	80	6	A(B*)	531×637	705×670	552×670	565×754	738×787	585×787	66.0	57.0	73.0	64.0
4	80	80UZ43.7	TOS80UZ43.7	TS80UZ43.7	80UZA43.7	TOS80UZA43.7	TS80UZA43.7	80UZW43.7	TOS80UZW43.7	TS80UZW43.7	3.7	Three	1500/1800	D.O.L.	80	6	B(C*)	557×688	731×721	578×721	565×861	738×894	585×894	72.0	63.0	79.0	70.0
5	80	80UZ45.5	TOS80UZ45.5	TS80UZ45.5	—	—	—	—	—	—	5.5	Three	1500/1800	D.O.L.	80	8	D	595×899	768×927	615×927	—	—	—	129.0	125.0	—	—
6	80	80UZ47.5	TOS80UZ47.5	TS80UZ47.5	—	—	—	—	—	—	7.5	Three	1500/1800	D.O.L.	80	8	E	595×920	768×948	615×948	—	—	—	147.0	142.0	—	—
7	80	80UZ411	TOS80UZ411	TS80UZ411	—	—	—	—	—	—	11	Three	1500/1800	Star-Delta	80	8	F	602×981	776×1007	623×1007	—	—	—	178.0	173.0	—	—

*1 200~240V

*2 All weights excluding cable

Weights of guide rail fitting model excluding duckfoot bend

Model Selection 100mm

Curve No.	Discharge Bore mm	Standard Model			Automatic Model			Auto-Alternation Model			Motor Output kW	Phase	Speed (S.S.) 50Hz/60Hz min ⁻¹	Starting Method	Solids Passage mm	Cable Length m	Cable Code	Dimensions L×H mm						Dry Weight *2 kg			
		Free Standing	Guide Rail Fitting		Free Standing	Guide Rail Fitting		Free Standing	Guide Rail Fitting									Standard Model			Auto&Auto-Alternation Model			Standard Model		Auto&Auto-Alternation Model	
			TOS	TS		TOS	TS		TOS	TS								Free Standing	TOS	TS	Free Standing	TOS	TS	Free Standing	Guide Rail Fitting	Free Standing	Guide Rail Fitting
1	100	100UZ43.7	TOS100UZ43.7	TS100UZ43.7	100UZA43.7	TOS100UZA43.7	TS100UZA43.7	100UZW43.7	TOS100UZW43.7	TS100UZW43.7	3.7	Three	1500/1800	D.O.L.	100	6	B(C*)	627×737	846×777	651×777	632×910	851×950	656×950	79.0	70.0	86.0	77.0
2	100	100UZ45.5	TOS100UZ45.5	TS100UZ45.5	—	—	—	—	—	—	5.5	Three	1500/1800	D.O.L.	100	8	D	652×939	871×974	676×974	—	—	—	145.0	134.0	—	—
3	100	100UZ47.5	TOS100UZ47.5	TS100UZ47.5	—	—	—	—	—	—	7.5	Three	1500/1800	D.O.L.	100	8	E	652×960	871×995	676×995	—	—	—	159.0	148.0	—	—
4	100	100UZ411	TOS100UZ411	TS100UZ411	—	—	—	—	—	—	11	Three	1500/1800	Star-Delta	100	8	F	660×1021	879×1054	684×1054	—	—	—	191.0	180.0	—	—

*1 200~240V

*2 All weights excluding cable

Weights of guide rail fitting model excluding duckfoot bend

100mm

Performance Curves

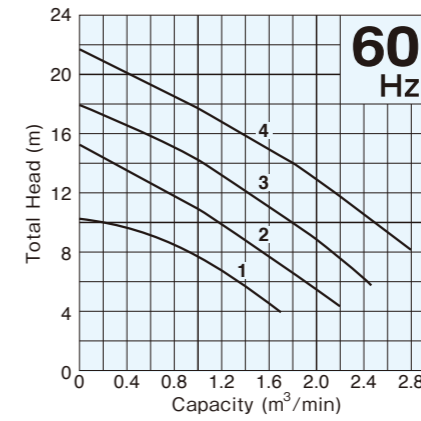
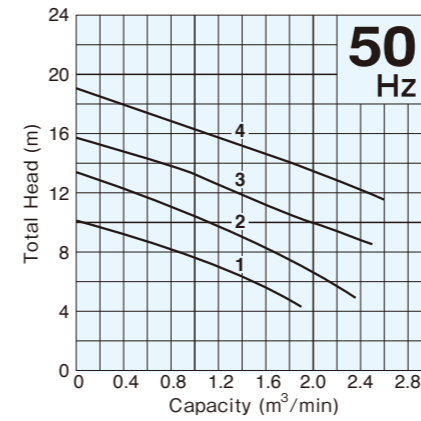

Dimensions

Free Standing

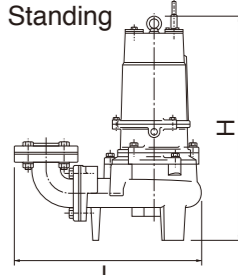

Guide Rail Fitting

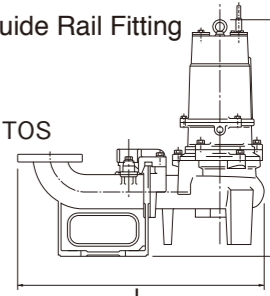

TS

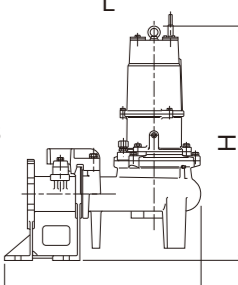

CABTYRE CABLE CODE REFERENCE

Single-Phase

Code	No. of Cables	Cores×mm ²	Outer Dia. mm	Material
a	1	3×1.25	10.1	PVC

Three-Phase

Code	No. of Cables	Cores×mm ²	Outer Dia. mm	Material
A	1	4×1.25	11.1	PVC
B	1	4×2.0	11.8	
C	1	4×3.5	13.9	

Code	No. of Cables	Cores×mm ²	Outer Dia. mm	Material
D	1	4×3.5	14.1	Chloroprene Rubber
E	1	4×5.5	16.8	
F	3	4×3.5	14.1	
		3×3.5	12.9	
		2×1.25	9.8	

TSURUMI OPTIONS

SPECIAL VERSION WITH GALVANIC CORROSION PROTECTION

In sea water, the effect of galvanic corrosion is more serious than that of ordinary corrosion. When two kinds of metals are dipped into an electrolytic liquid, a battery phenomenon occurs due to the difference in the electric potential of the two metals. In this case, the metal having the higher potential corrodes first. As an option, Tsurumi can supply pumps with parts made of higher electric potential metal as the sacrificial anode.

SPECIAL VERSION FOR HIGHER TEMPERATURE LIQUID

Standard pumps are designed for continuous running at the maximum ambient temperature of 40°C. In addition to these, Tsurumi can provide pumps for operation at higher liquid temperatures upon request. Refitting for operation at higher temperatures involves modification of not only the insulation of motor windings but also several components.

Two high-temperature operating models are available - the Rank 60 for operation in liquids up to 60°C and the Rank 90 for operation in liquids up to 90°C. Consult your dealer for more details. (These special versions are not available for some pump models.)

DRY PIT VERSION

The advantage of dry pit model is that it will not be damaged by flooding, as it is constructed with a submersible pump. Tsurumi can provide the dry pit model as option for the whole range of U/UZ-series pumps. The water jacket covers whole part of the motor. It efficiently cools the motor for continuous operations.

SPECIAL VERSION WITH NON-STANDARD MATERIALS

Tsurumi can also provide you with pumps with essential components such as the impeller, pump casing and the suction cover made of non-standard materials. Select from stainless steel, chromium iron and bronze to suit your specific requirements. Consult your dealer for more details.

SPECIAL ACCESSORIES

FLOAT SWITCHES

Tsurumi offers two types of float switches (liquid level sensors). A micro-switch is incorporated in both types.

Model MC-2 is a heavy-duty type float switch with a shock absorber. Having equipped with a high grade micro switch, the MC-2 assures trouble-free operation in the liquid containing much suspended solids and floating scum. Either of the two contacts, normally-open or normally-close, can be selected as required.

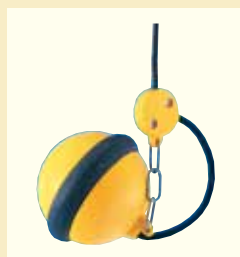

Model RF-5 is an economy type float which can detect upper/lower-limit water levels with single float. The snap on-off action ensures stable operation in clean or waste water containing suspended solids or oil and fat.



We reserve the right to change the specifications and designs for improvement without prior notice.

TSURUMI
MANUFACTURING CO., LTD.

Your Dealer